



# **SCHNEIDER**

***equipment for professionals***

## **PROFESSIONELLE PRODUKTE**

Für Bäckerei, Konditorei,  
Hotellerie und Gastronomie

## **PROFESSIONAL PRODUCTS**

For bakery, confectionery,  
hotels and gastronomy

**47**



## **Qualität aus Leidenschaft Equipment for professionals**

Mit über 3.000 unterschiedlichen Brotspezialitäten gibt es in Deutschland das umfangreichste Brotsortiment weltweit. Unsere Produkte kommen aber nicht nur für die Brotherstellung zum Einsatz. Mit mehr als 4.500 Artikeln arbeiten täglich Bäcker, Konditoren, Eishersteller, Chocolatiers, Caterer und Gastronomen – und dies weltweit in über 80 Ländern.

Über vier Jahrzehnte internationale Markterfahrung als familiengeführtes Unternehmen, wettbewerbsfähige und qualitativ hochwertige Produkte, kundenorientierter Service sowie unser umfangreiches Produktportfolio sind ein Garant für den Erfolg unserer langjährigen Geschäftspartner.

Unsere Händlertreue, rasche und weltweite Lieferungen – auch im Dropshipping – sowie ständige und innovative Neuheiten sind für uns selbstverständlich.

Mit unseren Produktionsmaterialien gehen wir so sparsam wie möglich um. Alternative Materialien und energieschonende und ressourcenschonende Produktionsmethoden stehen im Vordergrund. Eines unserer Ziele ist die Erreichung der CO<sub>2</sub>-Neutralität, u. a. durch den massiven Einsatz von Solarenergie.

Neben der ökologischen Verantwortung achten wir auf faire Arbeitsbedingungen in der gesamten Wertschöpfungskette. Wir führen unser Unternehmen zu 100 % zukunftsorientiert, für alle unsere Partner und für unseren Planeten.

[www.schneider-gmbh.com](http://www.schneider-gmbh.com)



## **Quality born of passion Equipment for professionals**

With over 3,000 bread specialities, Germany is the country with the largest variety of breads worldwide. But our professional equipment is not only used for bread making: Every day bakers, pastry chefs, confectioners, ice cream makers, chocolatiers, caterers and restaurateurs work with our over 4,500 articles in over 80 countries worldwide.

More than four decades of international market experience as a family-run company, competitive and high-quality products, customer-oriented service, and our extensive product portfolio are a guarantee for the success of our long-term business partners.

Our dealer loyalty, fast and worldwide deliveries – also in drop shipping – as well as our constant development and innovative new products are a matter of course for us.

We use our production materials as sparingly as possible. Alternative materials and energy-saving and resource-conserving production methods are in the foreground. One of our goals is to achieve CO<sub>2</sub> neutrality, among other things through the massive use of solar energy.

In addition to ecological responsibility, we pay attention to fair working conditions throughout the value chain.

We run our company 100 % future-oriented, for all our partners and for our planet.



	<b>Inhalt</b>   Content	3	
	<b>Stichwortsuche</b>   Alphabetical index	4 – 11	
	<b>Transport &amp; Lagerung</b>   Transportation & storage Trasporto e Stoccaggio   Transporte y almacenamiento	12 – 39	<b>1</b>
	<b>Backen</b>   Baking Cottura   Cocer	40 – 57	<b>2</b>
	<b>Backformen</b>   Baking moulds Stampi   Moldes	58 – 71	<b>3</b>
	<b>Silikon-Backformen</b>   Silicone baking moulds Stampi in silicone   Moldes en silicona	72 – 87	<b>4</b>
	<b>Ausstecher</b>   Cutters Tagliapasta   Cortapastas	88 – 105	<b>5</b>
	<b>Fachgeräte</b>   Utensils Utensili   Utensilios	106 – 161	<b>6</b>
	<b>Thermometer</b>   Thermometers Termometri   Termómetros	162 – 167	<b>7</b>
	<b>Arbeitsschutz</b>   Protection Protezione   Protección	168 – 173	<b>8</b>
	<b>Präsentieren</b>   Presentation & Display Presentazione   Presentación	174 – 203	<b>9</b>
	<b>Dekorieren</b>   Decoration Decorazioni   Decoración	204 – 227	<b>10</b>
	<b>Eis</b>   Ice cream Gelato   Helado	228 – 233	<b>11</b>
	<b>Schokolade</b>   Chocolate Cioccolato   Chocolate	234 – 267	<b>12</b>
	<b>Gebäckfüller &amp; Dosierspender</b>   Cream injectors & Dosing dispensers Riempitrici & Dosatore   Dosificadoras	268 – 291	<b>13</b>
	<b>Küchenzubehör &amp; Utensilien</b>   Kitchen Accessories & Tools Accessori e Utensili da Cucina   Accesorios y Utensilios de Cocina	292 – 345	<b>14</b>
	<b>Pizza-Zubehör</b>   Pizza Accessories Accessori per Pizza   Accesorios para Pizza	346 – 353	<b>15</b>
	<b>Messer &amp; Zubehör</b>   Knives & Accessories Coltelleria & Accessori   Cuchilleria & Accesorios	354 – 375	<b>16</b>
	<b>Technische Papiere</b>   Technical papers Carta in rotoli   Rollos de papel	376 – 381	<b>17</b>
	<b>SB-Displays</b>   SB-Displays	382 – 383	
	<b>Artikelnummern-Index</b>   Item number index	384 – 395	
	<b>Materialeigenschaften</b>   Material characteristics	396 – 402	

## D STICHWORTREGISTER

Artikel	Seite	Artikel	Seite	Artikel	Seite
<b>A</b>					
ABDECKHAUBEN	189	BACKKRAHMEN „HERZ“	149	DIGITALER	
ABREISSGERÄTE	52	BACKKRAHMEN, VERSTELLBAR	151	EINSTICHTHERMOMETER	162, 166, 167
ABROLLGERÄT	53	BACKTRENNFOLIE	53	DONUT-AUSSTECHER	93
ABSTECHER	110, 112	BACKTRENNPAPIERE	50, 51	DONUTS-SILIKONFORM	79, 87
ABTROPFSTÄNDER	374	BACKTRENNPAPIERE „RONDEN“ UND „RINGREIN“	49	DOSENÖFFNER	336
ABZIEHSTAHL	371	BAGUETTEBLECHE	49	DOSIERFLASCHE	134
AIRBRUSH KOMPRESSOR	213	BAUMWOLLHANDSCHUHE	171	DOSIERGERÄT „PRALINENFIX“	235
ALLZWECKZANGEN	199	BEHÄLTERWAGEN	39	DOSIERMASCHINE „EDHARD“	268 – 270
APFELAUSSTECHER	335	BERLINER TÜLLE	217	DOSIERSYSTEM	283
APFELSCHÄLMASCHINE	161	BISKUIT-SILIKONFORM	75, 83	DREIECK-AUSSTECHEWALZEN	115
APFELTEILER	335	BLECHANFASSER	171	DRUCKKNOPF	
ARBEITSSCHÜRZEN	172	BRATENTÖPFE	311	DOSIERSPENDER	284, 285, 288, 289
ASPIK-FORMEN	68	BRATPFANNEN	309	DRUCKPUMPENZERSTÄUBER	135, 305
AUFSATZ „HOT & COLD“	21, 25	BREZEL-SCHNEIDE-SET	364	DRÜCKSIEB	141
AUFSATZRAHMEN	16, 25	BREZELSCHIESSER	149	<b>E</b>	
AUFSCHNITTMESSER	360	BREZELSTÄNDER	198	ECLAIRS-SILIKONFORM	79
AUSBACKSCHIESSER	144, 145	BRIOCHE-SILIKONFORM	74, 81	EIERSTÜCKLER / EIERTTEILER	334
AUSBEINMESSER	368, 370	BRIOCHEFORMEN	63, 69	EIMER	33
AUSGLEICHSVORRICHTUNG	277	BRÖTCHENDRÜCKER	125	EINHANDSIEB	141
AUSKÜHLPLATTEN	351	BRÖTCHENMESSER	363	EINSTECKKARTEN	17, 22
AUSLAGESCHALEN	179	BROTDRÜCKER	125	EINWEGSPRITZBEUTEL	210 – 212
AUSLAGETABLETTS	174 – 183	BROTFORMEN	66, 122 – 124	EISBEHÄLTER	230
AUSSTECHER	88 – 92, 100 – 105	BROTMESSER	360	EISDIPPER	229
AUSSTECHER-SÄTZE	88 – 92	BROTSTREICHER	118	EISPORTIONIERER	229
AUSSTECHMATTEN	98, 99	<b>C</b>		EISSCHALEN	230
AUSSTELLBLECHE	182, 183	CANNOLI	158	EISSPACHTELN	228
<b>B</b>					
BABA-FORMEN	68	CATERING-EINSCHUB	16	EISTÜTENHALTER	232, 233
BABA-SILIKONFORM	74	CHEF 9000	303	EIWEISS-SCHÜSSELN	137
BACK-TRENNSPRAY	54, 302	CREME-FORM-SILIKONFORM	82	ELEKTRONISCHER TIMER	167
BACKBLECHE	40 – 44	CREME-FORMEN	332	ENGHALSFLASCHE	134
BACKBLECHE / KONVEKTOMATENBLECHE	306, 307	CREPES-EISEN	343	EPP-BOXEN	12 – 27
BACKBLECHMESSER	358	CREPES-SCHIEBER	343	ERSATZ-SCHNEIDEBRETT	373
BACKBLECHVORSETZER	47	CREPES-WENDER	343	ERSATZDECKEL – 40 x 60	21
BÄCKER-KLINGE	363	<b>D</b>		ERSATZDECKEL – PIZZA	27, 353
BÄCKERMESSER	354, 358	DARIOLFORMEN	332	ERSATZDECKEL TOP-BOX GN 1/2	19
BACKFORMEN – PAPIER	57	DECKEL FÜR EISBEHÄLTER	230	ERSATZDECKEL TOP-BOX ICE	25
BACKFORMEN AUS SILKON	72 – 87	DECKEL FÜR PIZZABALLENBOX	33, 346	ETAGEN-TORTENSTÄNDER	193 – 195
BACKHANDSCHUH NEOPREN	169, 329	DECKEL FÜR SCHÜSSELN	128, 322	<b>F</b>	
BACKHANDSCHUHE „PREMIUM“	168	DECKEL FÜR STAPELBEHÄLTER	32	FAHRGESTELLE	17, 23
BACKHANDSCHUHE „STANDARD“	169	DECKEL FÜR TEIGWANNEN	32, 129	FAHRGESTELL FÜR BACKTRENNPAPIER	52
BACKHANDSCHUHE LEDER	170, 171	DECKEL FÜR TÖPFE UND PFANNEN	311	FAHRGESTELL FÜR KÜBEL	31
BACKHANDSCHUHE SILIKON	169, 329	DEKOR-AUSSTECHER	88 – 92, 94 – 97	FETTPAPIERHALTER	190
BACKLINEALE	155	DEKOR-SPRITZBEUTEL	208	FILIERMESSER	359
BACKMATTEN	54	DEKOR-TÜLLEN	218 – 222	FLACHBESEN	126, 326
BACKOFENBESEN	119	DEKORIERPLATTEN	186 – 188	FLASCHEN- UND DOSENÖFFNER	336
BACKPALETTEN	357	DESSERT- UND TORTENRINGE	146, 147	FLASCHENWÄRMER	282
		DESSERTTRINGE	146, 147, 150, 152	FLEISCHGABEL	316

## D STICHWORTREGISTER

Artikel	Seite	Artikel	Seite	Artikel	Seite
FLEISCHTÖPFE	310	GROSSKÜCHENSIEBE	327	KONTAKTGRILL	339
FLORENTINER-SILIKONFORM	73, 81	GUGELHUPF-FORM	59	KONVEKTOMATENBLECH	44, 45
FLORENTINERRING	147	GUGELHUPF-SILIKONFORM	76, 82, 87	KREIDESTIFTE	203
FOLIEN-ABREISS-VORRICHTUNG	344, 345	GYROS-MESSER	367	KÜBEL	31
FONDANTTRICHTER / SAUCENPORTIONIERER	303	<b>H</b>		KUCHEN- & TORTENPLATTEN	181, 187
FRANKFURTER KRANZFORM	59	HACCP MARKIERUNGS-CLIPS	295, 297, 298	KUCHENBLECH	61, 66
FRANZÖSISCHE TÜLLEN	216	HANDBÜRSTE FÜR GÄRKÖRBE	124	KUCHENBLECHMESSER	355, 356, 358
FRISCHHALTEFOLIE	344	HANDENTSTEINER	161	KUCHENPALETTEN	362
FRITTIERSCHAUFEL	314	HANDSCHIESSER	145, 351	KÜCHENMESSER	355, 367
FRONT-BOX – 40 x 60	22	HANDSCHLAGKESSEL	133	KÜCHENSIEBE	318
FRONT-BOX GN 1/1	18	HAUSHALTS-SPRITZBEUTEL	208	KÜHLAKKU FRONT-BOX 40 x 60	23
FRÜCHTE ABLAUF-SET	128, 323	HEBEL DOSIERSPENDER	286 – 288, 290	KÜHLAKKUS „COLD“	29
FRÜHSTÜCKSMESSER		HEBEL DOSIERSPENDER MIT DONUT-AUFSATZ	281	KÜHLPLATTEN	28, 202
THEKEN-DISPLAY	364	HEBEL-DOSIERSPENDER / TEIGDOSIERER – STANDGERÄT	342	KÜHLTHERMOMETER	165
FUSS FÜR EIWEISS-SCHÜSSELN	137	HERZFORM	62, 63	KUNSTSTOFF-BAND	191
FUSS FÜR HANDSCHLAGKESSEL	133	HILFSWERKZEUG FÜR HEBELDOSIERSPENDER	291	KUPPLUNGSSTÜCK FÜR TRICHTER	273
FUSSBALLFELD-BACKFORM	64	HOCHZEITSTORTENSTÄNDER	193 – 195	KUVERTÜRE- / SCHOKOLADE-ABSTECHER	239
<b>G</b>		HÖRNCHENBACKFORM	158	<b>L</b>	
GÄRKÖRBE	122 – 124	<b>I</b>		LAMM-FORM	65
GÄRTÜCHER	124	IGELFORMEN	63	LEBENSMITTELBEHÄLTER	30
GASBRENNER	330, 331	INDUKTIONSKOCHFELD	308	LIKÖR- UND FONDANTTRICHTER	302
GASTRO-BLECH – UNIVERSAL	48	INFRAROT-THERMOMETER	163	LINERLESS-ENDLOSETIKETTEN	380
GASTRO-BRENNER	330, 331	<b>K</b>		LOCHBLECH	40 – 44
GASTROHANDSCHUH	169, 329	KAISERSEMELDRÜCKER	125	LOCHTÜLLEN	215, 226
GEBÄCKFÜLLER	279, 290, 291	KARAMELLISIERER	330, 331	LOCHTÜLLEN-SATZ	215
GEBÄCKFÜLLER „BLICKLE“	280	KARTOFFELSTAMPFER	319	LÖFFELFLÖTE / LÖFFELBEHÄLTER	231
GEBÄCKKAPSELN	56	KÄSETORTENFORM	60	<b>M</b>	
GEBÄCKSPRITZE	279	KASSENROLLEN HOLZFREI	378	MADELEINE	64
GEMÜSEHOBEL / MANDOLINE	320	KASSEROLLE	130, 239, 322	MADELEINE-SILIKONFORM	81
GEMÜSEMESSER	368	KASTENFORM	66	MAGNETFORMEN	267
GEWÜRZDOSE	328	KEBAP-MESSER	367	MAGNETLEISTE	374
GEWÜRZSCHAUFELN	138, 139	KELLNER-/NOTABLOCKS	203	MARZIPAN-MODELLIERSET	159
GITTERHAUBE	36	KESSELSCHABER	107	MARZIPAN-MODELLIERSTÄBE	159
GITTERSCHNEIDER	115	KLIMASCHUTZHAUBE	36	MASCHINENSCHLAGKESSEL	133
GLASIERTISCH	38	KNOBLAUCHPRESSE	335	MASSENRÜHRSPATEL	113
GLASURPALETTEN	357, 361	KOCHMESSER	366, 367	MEHLBESEN	119
GLASURTRICHTER	141	KOCHMÜTZEN	173	MEHLSCHAUFELN	138, 139
GLÄTTER FÜR FONDANT	159	KOCHTÖPFE	310	MEHLSIEBE	142, 143
GN BEHÄLTER AUS EDELSTAHL	298	KONDITORLÖFFEL	113	MESSBECHER	140, 141, 325
GN BEHÄLTER AUS POLYCARBONAT	294	KONDITORMESSER	355, 358	MESSBECHER-DECKEL	140
GN BEHÄLTER AUS POLYPROPYLEN	296	KONFITÜREN-SCHÜSSELN	136	MESSBECHER-SET	140
GN DECKEL	295, 297	KÖNIGSKUCHENPLATTEN	181	MESSER	354 – 364
GN EINSATZ	297	KÖNIGSKUCHEN-SILIKONFORM	87	MESSER-ABSTREIFBEHÄLTER	375
GOURMET PASSIERSIEBE	318	KÖNIGSKUCHENFORM	61, 71	MESSER-STERILISIERUNGSGERÄT	371
GRILLROSTE	45, 157, 307			MESSERLEISTE	374
GRILLZANGE	199			MESSSCHAUFELN	138
				MODELLIERSET	159

## D STICHWORTREGISTER

Artikel	Seite	Artikel	Seite	Artikel	Seite
MUFFIN-FORM	64			SCHOKOLADEN-SPENDER	237
MUFFINFORM „TULPE“	56	<b>R</b>		SCHOKOLADE TEMPERIERGERÄTE	237
MUFFINFORMEN-VERBUND	57	RAHM- UND CREMEROLLEN	158	SCHOKOLADEN-FONTÄNE	234
MUFFINFORMEN-VERBUND „TULPE“	55	RAHMEN FÜR		SCHOKOLADEN-FORMEN	240 – 266
		SCHNITTKUCHENBLECH	48, 191	SCHÖPFKELLEN	314
<b>N</b>		REFRAKTOMETER	165	SCHÜSSELN	128, 130, 132, 324
NIESSCHUTZ	198	REGALWAGEN	34, 35, 37	SD-PAPIER ROLLEN	380
NUDELZANGEN	197	REHRÜCKENFORM	62	SEIHER	130, 323
		REIBEN	321	SEITENTEIL FRONT-BOX 40 x 60	23
<b>O</b>		REINIGUNGSBÜRSTE	119, 234, 339	SERVIERLÖFFEL	315
OBSTTORTENFORM	61	RODONFORM	59	SERVIERTABLETTS	180, 231
OLIVENENTSTEINER	335	ROLLHÖLZER / TEIGROLLE	118	SERVIERWAGEN	38
		ROSENTÜLLEN	217	SERVIERZANGE	199
<b>P</b>		RÜHRBESEN	126, 127, 326, 327	SERVIETTENSPENDER / -HALTER	231
PALETTE MIT WELLENSCHLIFF	356	RÜHRKEULEN	113	SILIKON-BACKFORMEN	72 – 87
PAPIERMÜTZE „SCHIFFCHEN“	173	RÜHRMASCHINE	303	SILIKONPINSEL	120
PASSIERSIEBE	327	RÜHRSCHÜSSELN	128, 132, 324	SIRUP-SCHÜSSELN	137
PASTETENAUSSTECHE	328	RÜHRSPATEL	113, 319	SNACK-BLECH	183
PENDELSCHÄLER	334	RUNDSIEBE	142, 143	SNACK-VERKAUFSSTÄNDER	184, 185
PERGAMENTERSATZ	51			SNACKWELLEN	184, 185
PETIT-FOURS-AUSSTECHE	93	<b>S</b>		SPACHTELN	110, 312
PFANNENWENDER	315, 362	SACKSCHAUFELN	139	SPAGHETTILÖFFEL	316
PINSEL	120, 121	SAHNE-ABDECKPAPIERE	190	SPARSCHÄLER	334
PINZETTEN-ZANGEN	200	SAHNEKAPSELN	338	SPITZSIEBE	318
PIZZA BALLEBOX	33, 346	SAHNESPENDER	338	SPRINGBLECH	60
PIZZA BLECHZANGE	350	SALAT SCHLEUDER	337	SPRINGFORM	60
PIZZA BOXEN	26, 27, 352, 353	SALAT ZANGEN	197	SPRITZBEUTEL	206 - 215
PIZZA GITTER / PIZZA-SCREEN	349	SANDKLANZFORM	59, 71	SPRITZBEUTEL-ABSETZSTÄNDER	209
PIZZA OFENBÜRSTE	346	SANTOKU	367	SPRITZBEUTEL-WANDAUFHÄNGER	209
PIZZA SCHAUFELN	347	SAUCENLÖFFEL	316	SPRITZTÜLLEN-SET	223
PIZZA TEIG-DOCKER	351	SAUTEUSEN	311	SPRÜHFLASCHEN	134, 135
PIZZA WENDER	362	SAVARIN-FORMEN	69	SPRÜHPISTOLE „ALEXO 200“	304
PIZZA WIEGEMESSER /		SAVARIN-SILIKONFORM	73	SPRÜHPISTOLE „ALEXO 400“	305
PIZZA TEILER	350	SB-DISPLAYS	382, 383	SPRÜHPISTOLE „ALEXO 500“	239
PLANETEN-RÜHRMASCHINE	303	SCHABER EDELSTAHL	109, 231	SPUCK- UND NIESSCHUTZ	198
PRALINEN- / TRÜFFELGITTER	156, 157	SCHAUMLÖFFEL	314	STABMIXER	300, 301
PRALINEN-/ PETITS		SCHIFFCHEN	68	STÄNDER FÜR DRUCKKNOPF	
FOURS-FÖRMCHEN	69	SCHIFFCHEN-SILIKONFORM	87	DOSIERSPENDER	289
PRALINEN-VORRATSDOSE	238	SCHILLERLOCKENFORMEN	158	STÄNDER FÜR KUCHEN- UND	
PRALINENSCHNEIDER „GITARRER“	236	SCHLACHTMESSER	360	PIZZABLECHE	348, 349
PRALINENTUNGABELN	238	SCHLAGSCHÜSSELN	132, 324	STAPELBEHÄLTER	32
PRÄSENTIER-STÄNDER	48, 190	SCHLESINGER	108	STECHEMESSER	370
PREISSCHILDER	202	SCHNEEBESEN	126, 127, 326, 327	STEG FÜR GN BEHÄLTER	299
PROFI-DOSENÖFFNER	336	SCHNEIDBRETTER	372, 373, 374	STERNBANDTÜLLEN	217
PUDERZUCKERSIEBE	142, 143	SCHNEIDEBRETT + SAFTSCHALE	373	STERNTÜLLEN	214, 216, 226
PUMPEINHEITEN	272	SCHNEIDEBRETT-SET HACCP	373	STERNTÜLLEN-SATZ	214
		SCHNEIDEBRETT-HOBEL	374	STIELE	144
<b>Q</b>		SCHNITTEN-/BACKRAHMEN	151	STIELKASSEROLLEN	311
QUERSCHÄLER	334	SCHNITTENRAHMEN	155	STIELSCHABER	111, 112
QUETSCHFLASCHEN	283	SCHNITTKUCHENBLECH	46, 47		
QUICHE-FORMEN	63, 70	SCHNITTKUCHENBRÜCKE	48, 190		

## D STICHWORTREGISTER

Artikel	Seite	Artikel	Seite	Artikel	Seite
STIELSCHABER MIT THERMOMETER	111, 164	TORTENBLECH	148	WAGEN FÜR FAHRGESTELLE & TORTENRINGE	39
STIPPROLLER	114	TORTENBODENSÄGE	153	WANDAUFHÄNGER	130
STOLLENFORM	67	TORTENEINTEILER	154	WANDHALTERUNG FÜR EINWEGSPRITZBEUTEL	213
STOLLENRING	149	TORTENGITTER	156, 157	WÄRMEAKKUS	28
STREICH- UND BUTTERMESSE	363	TORTENGITTERSTANZE	153	WARMHALTEGERÄT	290
STREUER	319, 328	TORTENHAUBEN	189	WARMHALTEPLATTE	17
STRUDELWALZEN	114	TORTENHEBER	196	WASSER-SPRÜHPISTOLE / GEBÄCKSPRÜHER	160
<b>T</b>		TORTENMESSER	356, 358	WEIHNACHTSSTERN-FORM	63
TEIG- UND PIZZASCHNEIDER	117, 350	TORTENPLATTEN	186 – 188	WELLEN-BROTMESSE	356
TEIGABSTECHER MIT GRIFFLEISTE	107	TORTENPLATTEN – HALBKREIS	186	WETZSTAHL	371
TEIGBEHÄLTERWAGEN	39	TORTENRING-SET	148	WINKELPALETTE	357, 361
TEIGDOSIERER	342	TORTENRINGE	146, 147, 149, 150	WOLFSZAHNBLECH	62
TEIGDRÜCKER	125	TORTENRINGPALETTE	357, 361	WRAP-HALTER	185
TEIGSCHABER	106 – 109	TORTENSCHIBEN	148	WURSTSTÄNDER	198
TEIGSCHABER – FLEXIBEL	106	TORTENSCHIBENSTÄNDER	148	WURSTZANGEN	200
TEIGSCHABER „SCHLESINGER“	108	TORTENSCHUTZ	191		
TEIGSCHABER / KUCHENLÖSER	60	TORTENSPITZEN + SETS	192	<b>Z</b>	
TEIGSCHNEIDER	116, 117	TOURNIERMESSE	358	ZABAIONESCHÜSSELN	136
TEIGWANNEN	31, 32, 129, 346	TRANSPORTHILFE – BÄCKER – 40 x 60	21	ZANGEN	196, 197, 199
TELEFAX-ROLLEN	378	TRANSPORTHILFE – GN 1/1	17, 18	ZIMTSTERN-AUSSTECHER	93
THEKEN-DISPLAY		TRANSPORTHILFE – TORTE & PIZZA	27, 353	ZIP-HYGIENE-HANDSCHUH	172
FRÜHSTÜCKSMESSE	364	TRANSPORTWAGEN	34 – 37	ZUBEHÖR „EDHARD“	273 – 277, 278
THEKEN-DISPLAY VESPERMESSE	364	TRICHTER	134	ZUBEHÖR FÜR DOPPELFORMEN	240
THEKENABTRENNUNG	182	TRICHTER „EDHARD“	271, 272	ZUBEHÖR SPRÜHPISTOLE „ALEXO 200 + 400“	304
THEKENAUFSTELLER	201	TRÜFFELFÜLLER	302	ZUCKERSIEBE	142, 143
THEKENAUFSTELLER FÜR HYGIENISCHEN SCHUTZ	201	TRÜFFELGITTER	156, 157	ZUCKERSTREUER	328
THEKENBLECH / SNACK-BLECH	182, 183	TÜLLEN	214 – 227	ZUCKERTÖPFE	136
THEKENPRÄSENTER	200	TÜLLEN-ADAPTER	223, 224	ZUSCHNEIDMESSE	360
THERMO-GUEST-CHEQUES	203	TÜLLEN-ADAPTER-SET	207	ZUTATENBEHÄLTER / VORRATSBEHÄLTER	323
THERMO-ROLLEN FÜR KASSEN	377, 378	TÜLLEN-SET	225, 226, 227		
THERMO-ROLLEN FÜR WAAGEN	376	TÜLLENBÜRSTE	223		
THERMO-ROLLEN BLUE4EST	379	TÜRSCHLOSS	37		
THERMOMETER	162 – 167	<b>U</b>			
TIEFKÜHLMATTEN	54	UNIVERSALMESSE	355, 359		
TISCHAUFSTELLER	202	UNIVERSALSCHERE	371		
TOMATENSCHNEIDEGERÄT	337	<b>V</b>			
TOP-BOX – 40 x 60	20	VERSCHLUSS-CLIP	209		
TOP-BOX GN 1/1	15	VERSCHLUSSGRIFF	23		
TOP-BOX GN 1/2	19	VIERKANTREIBE	320		
TOP-BOX ICE 2 + 3	24	VORLEGEBESTECK	312, 313		
TOP-BOX PIZZA	26, 27, 352, 353	VORRATSBEHÄLTER	30, 131		
TORTELETT FORMEN	70	<b>W</b>			
TORTELETT – SILIKONFORM	74, 82	WAFFEL-SILIKONFORM	77, 87		
TORTEN- UND DEKORIERPLATTE – DREHBAR	216	WAFFELEISEN	340, 341		
		WAFFELSTÄBE	340		

## EN ALPHABETICAL INDEX

product	page	product	page	product	page
<b>A</b>					
ACCESSORIES FOR "EDHARD"	273 – 277, 278	BOTTLES	134, 135	CHRISTSTOLLEN MOULD	67
ACCESSORIES FOR DOUBLE MOULD	240	BOTTOM WARMER	282	CINNAMON STAR CUTTER	93
ACCESSORIES SPRAY GUN "ALEXO 200 + 400"	304	BOWL SCRAPERS	107	CLEANING BRUSHES	119, 234, 339
ADAPTER BAR	299	BOWL STRAINERS	327	CLEANING BRUSH FOR BREAD BASKETS	124
ADAPTER FOR FILLER UNITS	273	BOWLS	130	CLINGFILM	
AIRBRUSH COMPRESSOR	213	BREAD AND DOUGH MARKERS	125	TEAR-OFF-DISPENSERS	344, 345
AIRBRUSH PISTOLEN	213	BREAD BRUSHES	118	CLINGFILMS	344
ANGULAR KNIVES	358	BREAD KNIVES	360	COMPRESSED AIR SPRAYER	135, 305
ANGULAR SPATULAS	357, 361	BREAD MOULD	66	CONFECTIONER'S KNIVES	355, 358
APPLE CORER	335	BREAD PROOFING BASKETS	122 – 124	CONFECTIONERY FUNNEL	302
APPLE PEELING MACHINE	161	BREAKING KNIVES	370	CONTACT GRILL	339
APPLE SLICER	335	BRIOCHE MOULD	63, 68	COOLING PACK FRONT BOX 40 x 60	23
APRONS	172	BRIOCHE–SILICONE	74, 81	COOLING PACKS "COLD"	29
ASPIC MOULDS	68	BRUSH FOR TUBES	223	COOLING PLATES FOR PIZZA	351
<b>B</b>					
BABA – SILICONE	74	BRUSHES	120, 121	COOLING TRAYS	28, 202
BAGUETTE TRAYS	49	BRUSHES „SILICONE“	120	COTTON LINERS	124
BAKER BLADE	363	BUCKETS	31, 33, 288	COUNTER DISPLAY	364
BAKER'S KNIVES	354, 358	BUTCHER KNIVES	370	COUNTER DISPLAY "BREAKFAST KNIFE"	364
BAKING AND FREEZER MATS	54	<b>C</b>			
BAKING CASES	56	CAKE DISPLAY	46, 47	COUNTER DISPLAY "ALLROUND UTILITY KNIFE"	364
BAKING FOIL-PTFE	53	CAKE KNIVES	355, 356, 358	COUNTER SEPARATOR	182
BAKING FRAMES "HEART"	149	CAKE MOULD	61, 66	COUNTER SHOWCASE WITH SNEEZE GUARD	201
BAKING MITTENS "PREMIUM"	168	CAKE PLATES	148, 181, 186 – 188	CREAM CHARGERS	338
BAKING MITTENS "STANDARD"	169	CAKE POLISHER FOR SUGAR PASTE	159	CREAM COVERS	190
BAKING MITTENS LEATHER	170, 171	CAKE PROTECTION	191	CREAM HORN MOULDS STRAIGHT	158
BAKING MITTENS NEOPRENE	169, 329	CAKE RINGS, ADJUSTABLE	151	CREAM INJECTOR	279, 290, 291
BAKING MITTENS SILICONE	169, 329	CAKE SAW	153	CREAM INJECTOR "BLICKLE"	280
BAKING MOULDS – PAPER	57	CAKE SERVERS	196	CREAM ROLL MOULDS	158
BAKING MOULDS – SILICONE	72 – 87	CAKE SPATULAS	362	CREAM TART MOULDS	332
BAKING MOULDS–PAPER	57	CAKE STANDS	193, 193 – 195	CREAM WHIPPERS	338
BAKING RELEASE PAPERS	50, 51	CANNOLI	158	CREME-FORM–SILICONE	82
BAKING RELEASE PAPERS "RONDEN" (DISCS) AND "RINGREIN"	49	CASSEROLES	310	CREPE MAKER	343
BAKING TRAYS	40 – 45, 306, 307	CATERING SLIDE-IN UNIT GN 1/1	16	CREPE SPATULA	343
BALANCER	277	CHALK MARKERS	203	CREPE SPREADERS	343
BASE FOR MIXING BOWLS	133	CHEESE FLAN PAN	60	CUTLERY, HEAT-RESISTANT	312, 313
BASE FPR BOWLS	137	CHEF 9000	303	CUTTERS FOR PATE	328
BIRD'S BEAK PEELING KNIFE	358	CHEF'S KNIVES	366, 367	CUTTING BOARD SET HACCP	372, 373
BISCUIT / PASTRY SYRINGE	279	CHINESE COLANDER	318	CUTTING BOARD WITH DRIPPING TRAY	373
BLOWTORCH	330, 331	CHOCOLATE DISPENSER	237	CUTTING BOARDS	372, 373, 374
BOARD SCRAPER	374	CHOCOLATE / TRUFFLE GRATES	156, 157	CUTTING ROLLERS	114
BOAT MOULDS	68	CHOCOLATE FOUNTAIN	234	CUTTING SHEETS	98, 99
BONING KNIFE	370	CHOCOLATE GRATERS	239	<b>D</b>	
BOTTLE AND CAN OPENER	336	CHOCOLATE MELTERS	237	DECORATING BAG	208
		CHOCOLATE MOULDS	240 – 266	DECORATING CUTTERS	88 – 92, 94 – 97
		CHOCOLATE SPRAY GUN "ALEXO 500"	239	DECORATING PLATES	186 – 188
		CHRISTMAS STAR MOULD	63	DECORATION TUBES	218 – 222



## EN ALPHABETICAL INDEX

product	page	product	page	product	page
DENTS DE LOUP BISCUITS BAKING SHEET	62	FLORENTINES--SILICONE BAKING MOULD	73	HACCP MARKING CLIPS	295, 297, 298
DESSERT AND TART RINGS	146, 147	FLORENTINES--SILICONE BAKING MOULDS	73, 81	HANDLES	144, 149
DESSERT RINGS	146, 147, 150, 152	FLOUR AND SUGAR SIEVES	142, 143	HEART MOULD	62, 63
DIGITAL PROBE THERMOMETER	162, 166, 167	FLOUR BRUSHES	119	HEAT PACKS	28
DIPPING FORKS	238	FLOUR SCOOPS	138, 139	HEDGEHOG MOULD	63
DISPENSER	53	FOOD STORAGE CONTAINERS WITH LIID	131, 323	HORN MOULDS STRAIGHT	158
DISPENSERS FOR GREASE-PROOF PAPERS	190	FOOTBALL MOULD	64	HOT PLATE	17
DISPLAY RISER FOR SLICED CAKES	48, 190	FORAGE HAT	173	HYGIENE GLOVES	172
DISPLAY TRAYS	174 – 183	FRAME	155		
DISPOSABLE PASTRY BAGS	210 – 212	FRAME FOR CAKE DISPLAY SHEET	48, 191	<b>I</b>	
DOLLIES	17, 23, 192	FRENCH STAR TUBES	216	ICE CREAM CONE HOLDER	232, 233
DOLLY FOR BUCKETS	31	FRIDGE THERMOMETERS	165	ICE CREAM CONTAINERS	230
DONUTS--SILICONE	79, 87	FRITTER TUBE	217	ICE CREAM DIPPERS	229
DOOR LOCK	37	FRONT BOX – 40 x 60	22	ICE CREAM SCOOPS	229
DOSING DISPENSER – TABLE STANDING UNIT	342	FRONT BOX GN 1/1	18	ICE CREAM SPATULAS	228
DOSING METER “EDHARD”	268 – 270	FRUIT FLAN PAN	61	INDUCTION HOB	308
DOSING METER / FILLING MACHINE “PRALINEX D”	235	FRUIT STAINER SET	128, 323	INFRARED THERMOMETERS	163
DOSING METER / FILLING MACHINE “PRALINEX B”	235	FRYING PANS, NON-STICK	309	INGREDIENT STORAGE CONTAINERS	30
DOUGH AND PIZZA CUTTERS	117, 350	FUNNELS	134		
DOUGH CONTAINER – PIZZA	33, 346			<b>J</b>	
DOUGH CONTAINERS	31, 32, 129, 346			JAM BOWLS	136
DOUGH CUTTER	116, 117	<b>G</b>			
DOUGH DISPENSER	342	GARLIC PRESS	335	<b>K</b>	
DOUGH RULERS	155	GASTRO MITTENS	169, 329	KAISERSEMMEL MARKERS	125
DOUGH SCRAPERS	60, 106 – 109	GASTRO-TRAY UNIVERSAL	48	KEBAB KNIVES	367
DOUGH SCRAPERS – FLEXIBLE	106	GLAZE FUNNEL	141	KETTLES FOR MIXING MACHINES	133
DOUGH SCRAPERS “SCHLESINGER”	108	GLAZING TABLE / UTILIY RACK	38	KITCHEN KNIVES	355, 367
DOUGHNUT CUTTERS	93	GLOVES--MADE OF COTTON	171	KITCHEN SCISSORS	371
DRAINING RACK	374	GN CONTAINERS MADE OF POLYCARBONAT	294	KNIFE CLEANER	375
		GN CONTAINERS MADE OF POLYPROPYLEN	296	KNIFE-STERILIZER	371
		GN CONTAINERS MADE OF STAINLESS STEEL	298, 298	KNIVES	354 – 364
		GN INSERT / DRAINER PLATE	297		
		GN LID	295, 297	<b>L</b>	
		GOURMET BOUILLON-SIEVES	318	LADLE	314
		GOURMET SIEVES	327	LAMB MOULD	65
		GRATERS	320, 321	LATTICE CUTTING ROLLERS	115
		GRATES	156, 157	LATTICE MATRIX	153
		GREASEPROOF PAPER	51	LEVER DISPENSER WITH DONUT ADAPTER	281
		GRIDS	45, 157, 307	LEVER DISPENSERS	286–288, 290
		GRILL TONGS	199	LID FOR DOUGH CONTAINER	32, 129
		GUGELHUPF MOULD	59	LID FOR DOUGH CONTAINER – PIZZA	33, 346
		GUGELHUPF--SILICONE BAKING MOULDS	76, 82, 87	LID FOR STACKABLE CONTAINERS	32
		GUITAR CUTTERS	236	LID FOR STEWPOTS	311
		GYROS KNIFE	367	LIDS FOR MEASURING CUPS	140
				LIDS FOR MIXING BOWLS	128, 322
				LINERLESS LABELS	380
				LOAF CAKE MOULD	61, 71

## EN ALPHABETICAL INDEX

product	page	product	page	product	page
LOCKING FASTENER	23	PIZZA OVEN BRUSH	346	SAVARIN MOULDS	69
LOW FORAGE HAT	173	PIZZA PEELS	347	SAVARIN RING MOULD	59, 71
<b>M</b>		PIZZA SCREENS	348, 349	SCRAPERS	110, 112
MADELEINE	64	PIZZA SHEET TONG	350	SCRAPERS STAINLESS STEEL	109, 231
MADELEINE-SILICONE	81	PLAIN TUBES	215, 226	SCRAPERS WITH REINFORCED GRIP	107
MAGNET BAR	374	PLANETARY MIXER	303	SERVICE TROLLEY	38
MAGNET MOULDS	267	PLASTIC COVER-DISPOSABLE	36	SERVING SPOON	315
MARZIPAN MODELLING TOOLS	159	PLASTIC RIBBONS	191	SERVING TONGS	198
MEASURING CUPS	140, 141	PLUG-IN CARDS	17, 22	SERVING TRAYS	180, 231
MEASURING CUP-SET	140	PLUM CAKE-SILICONE	87	SET OF DECORATING TUBES	223
MEASURING SCOOPS, FREE STANDING	138	PLUM STONING DEVICE	161	SET OF PLAIN TUBES	215
MEAT FORK	316	POTATO MASHER	319	SET OF STAR TUBES	214
MENU BOARD	202	PRECISION TWEEZER TONGS	200	SET OF TART RINGS	148
MIXER	303	PRETZEL CUTTING DEVICE SET INCLUDING KNIFE	364	SETS OF PASTRY CUTTERS	88 – 92
MIXING BOWLS	128, 132, 133, 324	PRETZEL STAND	198	SHAKER	319
MIXING PADDLES	319	PROFESSIONAL CAN OPENERS	336	SHARPENING STEELS	371
MUFFIN PAN	64	PROTECTION	198	SHOWCASES	200, 201
MUFFIN TRAYS "TULIP"	55	PROTECTION COVERS	189	SIDE PANEL FRONT BOX 40 x 60	23
MULTI PURPOSE TONGS	199	PUMP DISPENSERS	284, 285, 288, 289	SILICONE BAKING MOULDS	72 – 87
<b>N</b>		PUMPS	272	SKIMMER	314
NAPKIN HOLDERS	231	<b>Q</b>		SLICER FOR VEGETABLES	320
<b>O</b>		QUICHE MOULDS	63, 70	SLICING KNIVES	360
OLIVE STONER	335	<b>R</b>		SNACK SALES RACKS	183 – 185
OVEN BROOMS	119	REFRACTOMETER	163	SPAGETTI SPOON	316
OVEN CLOTH	171	REPLACEMENT CUTTING BOARD	373	SPATULAS	110 – 15, 312, 315
OVEN PEELS	144, 145, 351	REPLACEMENT LID – 40 x 60	21	SPATULA WITH THERMOMETER	111, 164
<b>P</b>		REPLACEMENT LID – PIZZA	27, 353	SPEED PEELER	334
PASTA TONGS	197	REPLACEMENT LID TOP BOX GN 1/2	19	SPONGE CAKE – SILICONE BAKING MOULDS	75, 83
PALETTE KNIFE WITH SCALLOPED EDGE	356	REPLACEMENT LID TOP BOX ICE	25	SPOONS	113, 316
PALETTE KNIFE WITH SCALLOPED EDGE	356	RIDGED BAKING MOULD	62	SPOON HOLDERS	231
PALETTE KNIVES	357, 361	ROLL KNIVES	363	SPRAY GUN "ALEXO 200"	304
PAN	309	ROLLER DOCKERS	114	SPRAY GUN "ALEXO 400"	305
PAN FLIPPERS	362	ROLLING PINS	118	SPRAY GUN "ALEXO 500"	239
PASTRY BAGS	206 – 215	ROSE TUBE	217	SPREADING AND BUTTERING KNIFE	363
PASTRY BAGS FOR DOMESTIC USE	208	RUM BABA MOULDS	68	SPRINGFORM CAKE TIN	60
PASTRY CUTTERS	88 – 92, 100 – 105	<b>S</b>		SQUEEZE BOTTLES	283
PETIT FOUR CUTTERS	93	SALAD SPINNER	337	STACKABLE CONTAINERS	32
PETITS FOUR MOULDS	69	SALAD TONGS	197	STAND FOR DISPENSERS	289
PIE KNIVES	356, 358	SANTOKU	367	STAR RIBBON TUBES	217
PIPING TUBE ADAPTER	223, 224	SAUCE DISPENSER	283	STAR TUBES	214, 216, 226
PIPING TUBE ADAPTER SET	208	SAUCE STRAINERS	318	STEWPOTS	311
PIZZA CHOPPER	350	SAUCE WARMER	303	STICK BLENDER	300, 301
PIZZA DOUGH DOCKERS	351	SAUCEPANS	130, 239, 311, 322	STICKING KNIVES	370
PIZZA FLIPPER	362	SAUSAGE STAND	198	STOCK POTS	310
		SAUSAGE TONGS	200	STRAINER	130, 323
		SAUTEUSES	311	SUGAR DISPENSERS	328

## EN ALPHABETICAL INDEX

product	page	product	page	product	page
SUPPORT FOR CAKE PLATES	148	WAFFLE-SILICONE			
SUPPORT FOR CAKE- AND PIZZA MOLDS	349	BAKING MOULDS	77, 87		
SUPPORT FOR PASTRY BAGS	209	WAITER PADS	203		
SWIVEL PEELER	334	WALL HOLDER FOR DISPOSABLE PASTRY BAGS	213		
		WALL RACK	130		
<b>T</b>		WALL RACKS FOR PASTRY BAGS	209		
TABLETOP MENU BOARD	202	WARMING DEVICE	290		
TART MARKERS	154	WATER SPRAY GUN	160		
TART RINGS	146 – 151	WHISKS	126, 127, 326, 327		
TARTLET MOULD	70	WIRE SKIMMER	314		
TARTLET-SILICONE	74, 82	WRAP HOLDER	185		
TARTRING SPATULA	357, 361	WRENCH FOR LEVER DISPENSERS	291		
TEAR-OFF DISPENSERS	52				
THERMAL ROLLS BLUE4EST	379	<b>Y</b>			
THERMAL ROLLS FOR CASH REGISTERS	377, 378	YULE LOG MOULDS	332		
THERMAL ROLLS FOR SCALES	376				
THERMO-GUEST-CHEQUES	203	<b>Z</b>			
THERMOMETER	162 – 167	ZABAGLIONE BOWLS	136		
TILTING CAKE DECORATING – TURNTABLE	187, 216	ZIPPERED PLASTIC COVER	36		
TOMATO SLICER	337				
TONGS	196, 197, 199				
TOP BOX – 40 x 60	20				
TOP BOX GN 1/1	15				
TOP BOX GN 1/2	19				
TOP BOX ICE 2 + 3	24				
TOP BOX PIZZA	26, 27, 352, 353				
TOP FRAME „HOT & COLD“	21, 25				
TRANSPORT ASSISTANCE – BAKERS – 40 x 60	21				
TRANSPORT ASSISTANCE – CAKE & PIZZA	27, 353				
TRANSPORT ASSISTANCE – GN 1/1	16				
TRIANGULAR CROISSANT CUTTERS	115				
TRUFFLE FILLER	302				
TRUFFLE GRATES	156, 157				
TUBES	214 – 227				
TUBES SET	225, 226, 227				
<b>U</b>					
UNIVERSAL KNIVES	355, 359				
UTILIY RACK	34, 35, 37				
<b>V</b>					
VEGETABLE KNIVES	368				
<b>W</b>					
WAFFLE MAKERS	340, 341				
WAFFEL-STICKS	340				

# VORTEILE AUF EINEN BLICK...

ADVANTAGES AT A GLANCE...

VANTAGGI IN SINTESI...

VENTAJAS DE UN VISTAZO...



Für kalte Lebensmittel

For cold food

Per alimenti freddi

Para alimentos fríos

Durch Aussparung am Griff kann Wasser zuverlässig ablaufen

Water can drain reliably through recess on the handle

L'incavo sul manico permette all'acqua di defluire in modo affidabile

El rebaje del mango permite que el agua se escurra con seguridad

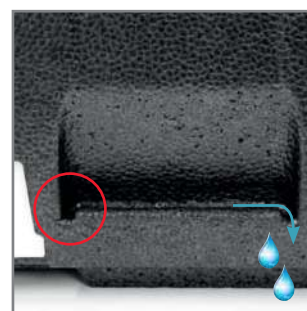

Für warme Lebensmittel

For hot food

Per alimenti caldi

Para alimentos calientes

Perfekt geformte Griffe sorgen für eine optimale Handhabung

Perfectly shaped handles ensure optimal handling

I manici perfettamente sagomati assicurano una maneggevolezza ottimale

Las asas de forma perfecta garantizan un manejo óptimo



Für frische Lebensmittel

For fresh food

Per alimenti freschi

Para alimentos frescos

Robustes Material gewährleistet eine optimale Isolierung

Robust material ensures optimal insulation

Il materiale robusto garantisce un isolamento ottimale

El material robusto garantiza un aislamiento óptimo



Einsteckkarten in 5 Farben für eine individuelle Beschriftung

Plug-in cards in 5 colors for individual labeling

Inserti in 5 colori per l'etichettatura individuale

Tarjetas de 5 colores para el etiquetado individual

Wasserabweisendes Material

Water resistant material

Materiale idrorepellente

Material hidrófugo

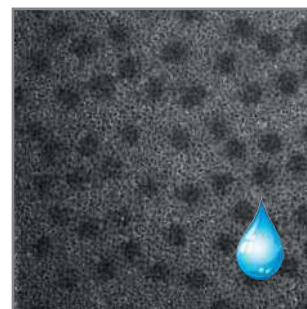



1

Ausgangstemperatur (warm halten)  
Initial temperature (keep warm)

87°C	85,6°C	84,4°C	82,8°C	81,2°C
1 Std./h	2 Std./h	3 Std./h	4 Std./h	

Ausgangstemperatur (kalt halten)  
Initial temperature (keep cold)

0,3°C	0,8°C	0,9°C	1,2°C	1,4°C
1 Std./h	2 Std./h	3 Std./h	4 Std./h	



Eine Griffmulde ermöglicht einfaches Öffnen übers Eck

A recessed grip allows easy opening across the corner

Le impugnature incassate consentono un'agevole apertura dall'angolo

Una empuñadura empotrada facilita la apertura desde la esquina

Hot & Cold  
Praktische Aufsatzrahmen für Wärme- und Kühlakkus

Practical extension frame for warm and cold packs

Pratici telai di fissaggio per piastra eutettica e accumulatore di calore

Prácticos bastidores de fijación para acumulador de frío y acumulador de calor

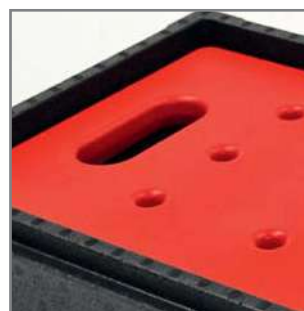

Aussparung an allen Seiten ermöglicht einfache Entnahme von Behältern aus der Box

Recess on all sides enables easy removal of containers from the box

L'incavo su tutti i lati consente di rimuovere facilmente i contenitori dalla box

El rebaje en todos los lados permite sacar fácilmente los contenedores de la caja

Passgenaue Platzierung der Behälter

Precise placement of the containers

Posizionamento preciso dei contenitori

Colocación precisa de los contenedores

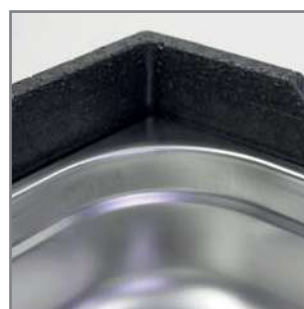

Passgenaues und sicheres Stapeln

Precise fit and safe stacking

Impilaggio preciso e sicuro

Apilado preciso y seguro

Praktischer und robuster Verschluss bei Frontboxen

Practical and robust closure for front boxes

Chiusura pratica e robusta per box frontali

Cierre práctico y robusto para cajas frontales



Praktische Kabelaussparung für die Verwendung von Wärmeplatten

Practical cable recess for the use of warming plates

Pratico alloggiamento per i cavi per l'utilizzo di piastre riscaldanti

Práctico hueco para cables para el uso de placas calentaplatos

Scharniere aus EPP  
Top hygienisch

Hinges made of EPP  
Top hygienic

Cerniere in EPP  
Top igienico

Bisagras de EPP  
Máxima higiene



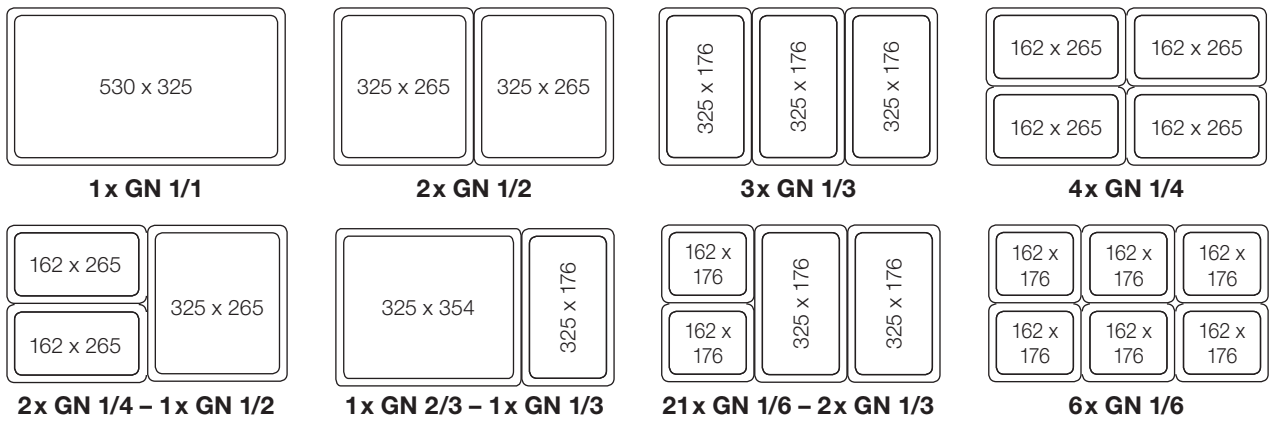

**Angaben zum Volumenvermögen Behälter GN 1/1**

Data on volume capacity container GN 1/1

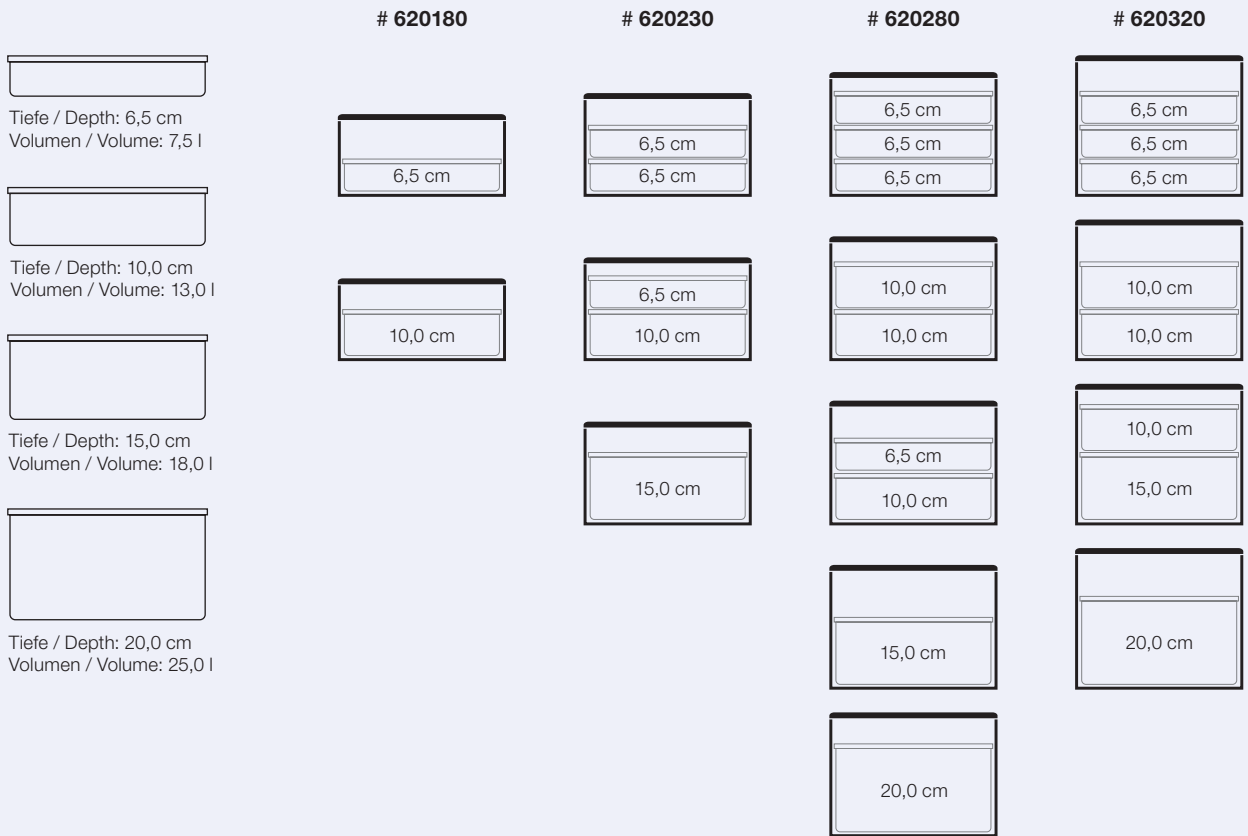

# TOP-BOX GN 1/1

- Inklusive Deckel
  - Inklusive Einsteckkarten-Set
  - Ergonomisches Griffdesign
  - Wasserdichte Innenoberfläche
  - Wasserrinne im Griff
  - Optimale Entnahme von Behältern  
GN 1/1 und GN 1/2 dank Aussparungen  
an allen 4 Seiten
- Including lid
  - Including plug-in card set
  - Ergonomic handle design
  - Waterproof inner surface
  - Water channel in the handle
  - Optimal removal of containers  
GN 1/1 and GN 1/2 thanks to  
recesses on all 4 sides

1

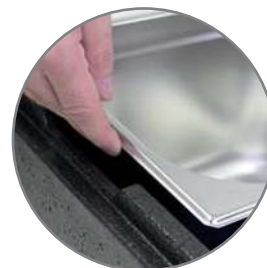
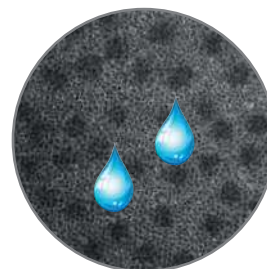

DE	TRANSPORTBOX TOP GN 1/1
EN	TRANSPORT BOX TOP GN 1/1
IT	TRANSPORTINO TOP GN 1/1
ES	CAJA DE TRANSPORTE TOP GN 1/1



#	↳ mm	mm	l
620180	600 x 400 x 180	538 x 338 x 117	21,0
620230	600 x 400 x 230	538 x 338 x 167	30,0
620280	600 x 400 x 280	538 x 338 x 217	39,0
620320	600 x 400 x 320	538 x 338 x 257	46,0

## ZUBEHÖR / ACCESSORIES



DE	ERSATZDECKEL		
EN	SPARE LID	EPP	GN 1/1
IT	COPERCHIO DI RICAMBIO		
ES	TAPA DE RECAMBIO		

- Passend für alle TOP GN 1/1
- Suitable for all TOP GN 1/1

#	↳ mm		
620990	600 x 400 x 35		

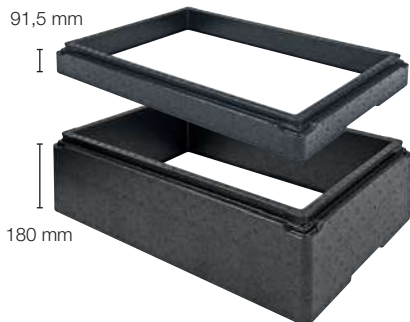

DE	AUFSATZRAHMEN		
EN	EXTENSION FRAME	EPP	GN 1/1
IT	CORNICE SUPERIORE		
ES	MARCO SUPERIOR		

- Passend für alle TOP GN 1/1
- Suitable for all TOP GN 1/1

#	↳ mm		
620900	600 x 400 x 91,5		
620920	600 x 400 x 180		



DE	AUFSATZ		
EN	TOP FRAME	EPP	GN 1/1
IT	CORNICE		
ES	MARCO		

- Passend für alle TOP GN 1/1
- Für Kühl- und Wärmekakus
- Suitable for all TOP GN 1/1
- For cold and warm packs

#	↳ mm		
620910	600 x 400 x 85		

**i** Kühl- und Wärmekakus auf Seite 29 / Cold and warm packs on page 29

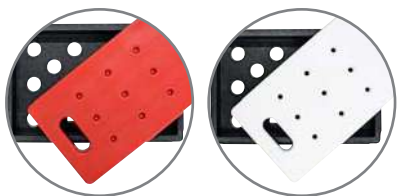

DE	EINSTECKKARTEN-SET		
EN	PLUG-IN CARD SET	LDPE	GN 1/1
IT	SET DI SCHEDE DA INSERIRE		
ES	JUEGO DE TARJETAS DE INSERCIÓN		

- Passend für alle TOP GN 1/1
- Suitable for all TOP GN 1/1

#			
690000	5-farbig / 5-color	○ ● ● ● ●	



DE	CATERING-EINSCHUB		
EN	CATERING INSERT	SST	GN 1/1
IT	INSERTO PER CATERING		
ES	INSERTO PARA CATERING		

- Passend für # 620320
- Längseinschub 3 Bleche GN 1/1
- Etagenabstand: ca. 80 mm
- Suitable for # 620320
- Longitudinal insertion 3 trays GN 1/1
- Floor distance: approx. 80 mm



#	☰	↗ mm	→ mm	↑ mm	
690010	3	320	336	269	





## ZUBEHÖR / ACCESSORIES

1

DE	WARMHALTEPLATTE	  
EN	WARMING PLATE	
IT	PIASTRA RISCALDANTE	
ES	PLACA CALIENTAPLATOS	





- |  |  |
|--|--|
| <ul style="list-style-type: none"> <li>• Passend für alle TOP GN 1/1</li> <li>• Schalttemperatur: 75°C</li> <li>• Regelung: vollautomatisch</li> <li>• Automatische Temperaturüberwachung</li> <li>• Vollflächige Temperaturübertragung</li> <li>• Kein Vorheizen notwendig</li> <li>• Unterseitige Carbon-Isolierung</li> <li>• Glatte und spritzwasserfeste Oberfläche</li> <li>• HACCP-konform</li> <li>• Länge Netzkabel: 2 m</li> </ul> | <ul style="list-style-type: none"> <li>• Suitable for all TOP GN 1/1</li> <li>• Switching temperature: 75°C</li> <li>• Control: fully automatic</li> <li>• Automatic temperature monitoring</li> <li>• Full surface temperature transfer</li> <li>• No preheating necessary</li> <li>• Carbon insulation on the underside</li> <li>• Smooth and splash-proof surface</li> <li>• HACCP compliant</li> <li>• Length of power cable: 2 m</li> </ul> |
|--|--|



#	↳→mm		
690100	480 x 280 x 10	100 W	230 V / 50-60 Hz

DE	TRANSPORTTROLLEY	
EN	DOLLY	
IT	CARRELLO DI TRASPORTO	
ES	CARRO DE TRANSPORTE	

- |   |  |
|---|--|
| <ul style="list-style-type: none"> <li>• Geeignet für alle TOP GN 1/1 (Außenmaß 60x40)</li> <li>• Geeignet für Behälter (Außenmaß 60x40)</li> </ul> | <ul style="list-style-type: none"> <li>• Suitable for all TOP GN 1/1 (external dimensions 60x40)</li> <li>• Suitable for containers (external dimensions 60x40)</li> </ul> |
|---|--|

#		<b>kg</b>
202085	 0/4 Lenkrollen feststellbar / 0/4 swivel castors lockable	ca. 250
202092	 1/4 Lenkrollen feststellbar / 1/4 swivel castors lockable	ca. 180
202096	 0/4 Lenkrollen feststellbar / 0/4 swivel castors lockable	ca. 250
202099	 0/4 Lenkrollen feststellbar / 0/4 swivel castors lockable	ca. 250



# FRONT-BOX GN 1/1



# 640699

Scharnier einfach und schnell wechselbar /  
Hinge can be changed easily and quickly

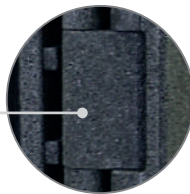

## Angaben zum Volumenvermögen Behälter GN 1/1

Data on volume capacity container GN 1/1

Tiefe / Depth: 6,5 cm  
Volumen / Volume: 7,5 l

Tiefe / Depth: 10,0 cm  
Volumen / Volume: 13,0 l

Tiefe / Depth: 15,0 cm  
Volumen / Volume: 18,0 l

Tiefe / Depth: 20,0 cm  
Volumen / Volume: 25,0 l

6,5 cm
6,5 cm
6,5 cm
6,5 cm
6,5 cm
6,5 cm

10,0 cm
10,0 cm
10,0 cm
10,0 cm

15,0 cm
15,0 cm
15,0 cm

20,0 cm
20,0 cm

Türe ist bis zu 270 °C  
schwenkbar /  
Door can be swivelled  
up to 270 °C



DE	TRANSPORTBOX FRONT GN 1/1
EN	TRANSPORT BOX FRONT GN 1/1
IT	TRANSPORTINO FRONT GN 1/1
ES	CAJA DE TRANSPORTE FRONT GN 1/1

- Geeignet für Behälter, Bleche in GN 1/1
- Inklusive Einsteckkarten-Set
- Ergonomisches Griffdesign
- Kabelaussparung für Wärmeplattenverwendung
- Suitable for containers, trays in GN 1/1
- Including plug-in card set
- Ergonomic handle design
- Cable recess for warming plate use

#	↳ mm	⏏ mm	⚖ l
620660	628 x 445 x 625	533 x 331 x 525	91,0



DE	TRANSPORTTROLLEY	
EN	DOLLY	
IT	CARRELLO DI TRASPORTO	GN 1/1
ES	CARRO DE TRANSPORTE	

#	ALU	2/4 Lenkrollen feststellbar / 2/4 swivel castors lockable	kg	für / for #
202094	ALU	2/4 Lenkrollen feststellbar / 2/4 swivel castors lockable	ca. 180	620660

**i** Zubehör auf Seite 23 / Accessories on page 23

**Angaben zum  
Volumenvermögen  
Behälter GN 1/2**

Data on  
volume capacity  
container GN 1/2

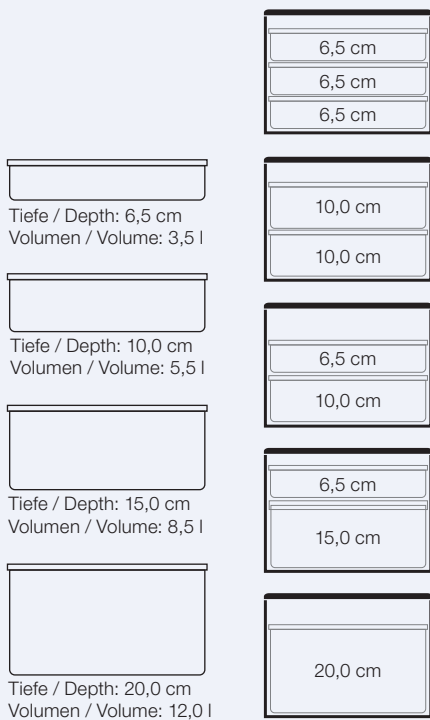

# TOP-BOX GN 1/2



DE	TRANSPORTBOX TOP GN 1/2
EN	TRANSPORT BOX TOP GN 1/2
IT	TRANSPORTINO TOP GN 1/2
ES	CAJA DE TRANSPORTE TOP GN 1/2

- Inklusive Deckel
- Ergonomisches Griffdesign
- Including lid
- Ergonomic handle design

#	←→ mm	↑ mm	∩ l
630280	390 x 330 x 280	330 x 270 x 217	19,0



DE	ERSATZDECKEL	EPP	GN 1/2
EN	SPARE LID		
IT	COPERCHIO DI RICAMBIO		
ES	TAPA DE RECAMBIO		

- Passend für TOP GN 1/2
- Suitable for TOP GN 1/2

#	←→ mm
630990	390 x 330 x 35



# TOP-BOX 60x40

- Geeignet für E2-Kisten, Stapelbehälter, Bleche in 60x40
- Inklusive Deckel
- Ergonomisches Griffdesign
- Suitable for E2 boxes, stacking containers, trays in 60x40
- Including lid
- Ergonomic handle design



# 640180 32,0 l
# 640220 42,0 l
# 640260 53,0 l
# 640360 80,0 l



DE	TRANSPORTBOX TOP 60x40
EN	TRANSPORT BOX TOP 60x40
IT	TRANSPORTINO TOP 60x40
ES	CAJA DE TRANSPORTE TOP 60x40

#	↳ mm	mm	l
640180	685 x 485 x 180	625 x 425 x 120	32,0
640220	685 x 485 x 225	625 x 425 x 160	42,0
640260	685 x 485 x 265	625 x 425 x 200	53,0
640360	685 x 485 x 365	625 x 425 x 300	80,0



DE	ERSATZDECKEL	
EN	SPARE LID	
IT	COPERCHIO DI RICAMBIO	EPP 60x40
ES	TAPA DE RECAMBIO	

- Passend für alle TOP 60x40
- Suitable for all TOP 60x40

#	↳ mm
640990	685 x 485 x 35



**i** Kühl- und Wärmeakkus auf Seite 29 /  
Cold and warm packs on page 29

DE	AUFSATZ		
EN	TOP FRAME	EPP	60x40
IT	CORNICE		
ES	MARCO		

- Passend für alle TOP 60x40
- Für Kühl- und Wärmekakus
- Suitable for all TOP 60x40
- For cold and warm packs

#	↔ mm
640900	685 x 485 x 85

### ZUBEHÖR / ACCESSORIES



DE	CATERING-EINSCHUB		
EN	CATERING INSERT	SST	60x40
IT	INSERTO PER CATERING		
ES	INSERTO PARA CATERING		

- Passend für # 640360
- Längseinschub 3 Auflagen 60x40
- Etagenabstand: ca. 85 mm
- Suitable for # 640360
- Longitudinal insertion 3 layers 60x40
- Floor distance: approx. 85 mm

#	≡	↗ mm	→ mm	↑ mm
690020	3	450	415	297

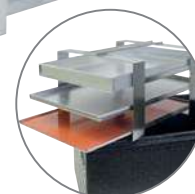
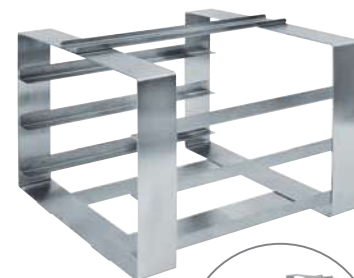

DE	TRANSPORTTROLLEY		
EN	DOLLY		60x40
IT	CARRELLO DI TRASPORTO		
ES	CARRO DE TRANSPORTE		

- Geeignet für alle TOP 60x40 (Außenmaß 68,5 x 48,5)
- Suitable for all TOP 60x40 (external dimensions 68.5 x 48.5)

#	ALU	kg
202086	0/4 Lenkrollen feststellbar / 0/4 swivel castors lockable	ca. 250



# FRONT-BOX 60x40



# 640699

Scharnier einfach und schnell wechselbar /  
Hinge can be changed easily and quickly

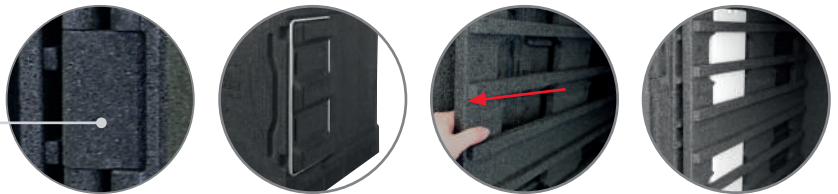

Türe ist bis zu 270 °C  
schwenkbar /  
Door can be swivelled  
up to 270 °C



DE	TRANSPORTBOX FRONT 60x40
EN	TRANSPORT BOX FRONT 60x40
IT	TRANSPORTINO FRONT 60x40
ES	CAJA DE TRANSPORTE FRONT 60x40

- Geeignet für max. 7 Bleche 60x40 / Schnittkuchenbleche
- Geeignet für Stapelbehälter 60x40 / E2-Kisten
- Inklusive Einsteckkarten-Set
- Ergonomisches Griffdesign
- Kabelaussparung für Wärmeplattenverwendung
- Optionaler Seiteneinschub mit einer Kapazität von bis zu 8 Kühl-Akkus
- Nutzhöhe: 60 mm
- Suitable for max. 7 trays 60x40 / cut cake trays
- Suitable for stacking containers 60x40 / E2 boxes
- Including plug-in card set
- Ergonomic handle design
- Cable recess for warming plate use
- Optional side insert with a capacity of up to 8 cold packs
- Usable height: 60 mm

#	↔ mm	↑ mm	↓ l
640640	710 x 587 x 685	615 x 405 x 585	146,0



DE	TRANSPORTTROLLEY
EN	DOLLY
IT	CARRELLO DI TRASPORTO
ES	CARRO DE TRANSPORTE

60x40

#	ALU	kg	für / for #
202097	2/4 Lenkrollen feststellbar / 2/4 swivel castors lockable	ca. 250	640640

**ZUBEHÖR /  
ACCESSORIES**

1

DE	KÜHLAKKU		
EN	COLD PACK		60x40
IT	PIASTRA EUTETTICA		
ES	ACUMULADOR DE FRIO		

- Passend für FRONT 60x40
- Suitable for FRONT 60x40

#	↗ mm	→ mm	↑ mm
281040	200	140	20

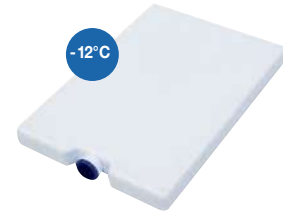

DE	SEITENEINSCHUB		
EN	SIDE INSERT	EPP	60x40
IT	INSERTO LATERALE		
ES	INSERTO LATERAL		

- Passend für FRONT 60x40
- Geeignet für linke oder rechte Seite
- Lieferumfang ohne Kühlakkus
- Suitable for FRONT 60x40
- Suitable for left or right side
- Delivery without cold packs

#	↗ mm	→ mm	↑ mm
640691	607	557	37



DE	SCHARNIER			
EN	HINGE	EPP	60x40	GN 1/1
IT	CERNIERA			
ES	BISAGRA			

- Passend für FRONT 60x40
- Passend für FRONT GN 1/1
- Suitable for FRONT 60x40
- Suitable for FRONT GN 1/1

#	↗ mm	→ mm	↑ mm
640699	80	35	142

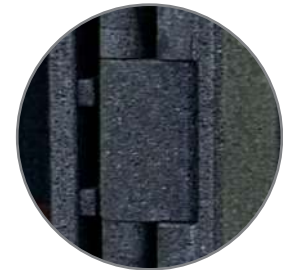

DE	VERSCHLUSSGRIFF			
EN	LOCKING HANDLE	SST	60x40	GN 1/1
IT	MANIGLIA DI CHIUSURA			
ES	ASA DE CIERRE			

- Passend für FRONT 60x40
- Passend für FRONT GN 1/1
- Suitable for FRONT 60x40
- Suitable for FRONT GN 1/1

#	↗ mm	→ mm	↑ mm
640692	450	250	10



DE	EINSTECKKARTEN-SET			
EN	PLUG-IN CARD SET	LDPE	60x40	GN 1/1
IT	SET DI SCHEDE DA INSERIRE			
ES	JUEGO DE TARJETAS DE INSERCIÓN			

- Passend für FRONT 60x40
- Passend für FRONT GN 1/1
- Suitable for FRONT 60x40
- Suitable for FRONT GN 1/1

#	
690000	5-farbig / 5-color ○ ● ● ● ●



# TOP-BOX ICE



DE	TRANSPORTBOX TOP ICE 2
EN	TRANSPORT BOX TOP ICE 2
IT	TRANSPORTINO TOP ICE 2
ES	CAJA DE TRANSPORTE TOP ICE 2



- Geeignet für 2 Eisbehälter # 199614  
360 x 250 x 120 mm, 8,7 L
- Geeignet für 1 Kühlakku GN 1/4 mittig
- Inklusive Deckel
- Ergonomisches Griffdesign
- Lieferumfang ohne Eisbehälter und Kühlakku
- Suitable for 2 ice containers # 199614  
360 x 250 x 120 mm, 8.7 l
- Suitable for 1 cold pack GN 1/4 centered
- Including lid
- Ergonomic handle design
- Delivery without ice containers and cold pack

#	↳ mm	mm	l
660215	600 x 400 x 215	2 x (360 x 250 x 120)	17,4



DE	TRANSPORTBOX TOP ICE 3
EN	TRANSPORT BOX TOP ICE 3
IT	TRANSPORTINO TOP ICE 3
ES	CAJA DE TRANSPORTE TOP ICE 3



- Geeignet für 3 Eisbehälter # 199612  
360 x 165 x 180 mm, 7,3 L
- Geeignet für 2 Kühlakkus GN 1/4 mittig
- Inklusive Deckel
- Ergonomisches Griffdesign
- Lieferumfang ohne Eisbehälter und Kühlakkus
- Suitable for 3 ice containers # 199612  
360 x 165 x 180 mm, 7.3 l
- Suitable for 2 cold packs GN 1/4 centered
- Including lid
- Ergonomic handle design
- Delivery without ice containers and cold packs

#	↳ mm	mm	l
660270	600 x 400 x 270	3 x (360 x 165 x 180)	21,9



**ZUBEHÖR /  
ACCESSORIES**

1

DE	ERSATZDECKEL		
EN	SPARE LID	EPP	ICE
IT	COPERCHIO DI RICAMBIO		
ES	TAPA DE RECAMBIO		

- Passend für alle TOP ICE
- Suitable for all TOP ICE

#	↔ mm	
660990	600 x 400 x 70	



DE	AUFSATZRAHMEN		
EN	EXTENSION FRAME	EPP	ICE
IT	CORNICE SUPERIORE		
ES	MARCO SUPERIOR		

- Passend für alle TOP ICE
- Suitable for all TOP ICE

#	↔ mm	
620900	600 x 400 x 91,5	
620920	600 x 400 x 180	



DE	AUFSATZ		
EN	TOP FRAME	EPP	ICE
IT	CORNICE		
ES	MARCO		

- Passend für alle TOP ICE
- Suitable for all TOP ICE
- Für Kühl- und Wärmekakus
- For cold and warm packs

#	↔ mm	
620910	600 x 400 x 85	

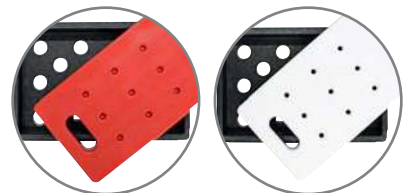

**i** Kühl- und Wärmekakus auf Seite 29 / Cold and warm packs on page 29



# TOP-BOX PIZZA

- Speziell für heiße Pizzen
- Auch geeignet für frische Lebensmittel, Getränke, Kuchen
- Inklusive Deckel
- Ergonomisches Griffdesign
- Especially for hot pizzas
- Also suitable for fresh food, drinks, cakes
- Including lid
- Ergonomic handle design

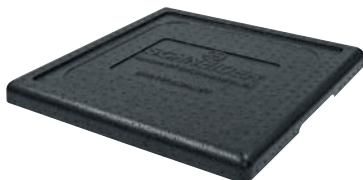

DE	TRANSPORTBOX TOP PIZZA
EN	TRANSPORT BOX TOP PIZZA
IT	TRANSPORTINO TOP PIZZA
ES	CAJA DE TRANSPORTE TOP PIZZA

#	←→ mm	⏏ mm	♻ l
650165	410 x 410 x 165	350 x 350 x 100	12,0
650240	410 x 410 x 240	350 x 350 x 175	21,0
650330 *	410 x 410 x 330	350 x 350 x 265	32,0
650395	410 x 410 x 395	350 x 350 x 330	40,0

DE	ERSATZDECKEL	
EN	SPARE LID	EPP PIZZA S
IT	COPERCHIO DI RICAMBIO	
ES	TAPA DE RECAMBIO	

- Passend für alle TOP PIZZA S
- Suitable for all TOP PIZZA S

#	←→ mm
650990	410 x 410 x 35



DE	TRANSPORTBOX TOP PIZZA
EN	TRANSPORT BOX TOP PIZZA
IT	TRANSPORTINO TOP PIZZA
ES	CAJA DE TRANSPORTE TOP PIZZA

#	↔ mm	↑ mm	∩ l
651165	480 x 480 x 182	420 x 420 x 117	21,0
651260 *	480 x 480 x 265	420 x 420 x 200	35,0



1

DE	ERSATZDECKEL	EPP	PIZZA	L
EN	SPARE LID			
IT	COPERCHIO DI RICAMBIO			
ES	TAPA DE RECAMBIO			

- Passend für alle TOP PIZZA L
- Suitable for all TOP PIZZA L

#	↔ mm
651990	480 x 480 x 35



DE	TRANSPORTBOX TOP PIZZA
EN	TRANSPORT BOX TOP PIZZA
IT	TRANSPORTINO TOP PIZZA
ES	CAJA DE TRANSPORTE TOP PIZZA

#	↔ mm	↑ mm	∩ l
652280	595 x 595 x 182	535 x 535 x 115	33,0



DE	ERSATZDECKEL	EPP	PIZZA	XL
EN	SPARE LID			
IT	COPERCHIO DI RICAMBIO			
ES	TAPA DE RECAMBIO			

- Passend für TOP PIZZA XL
- Suitable for TOP PIZZA XL

#	↔ mm
652990	595 x 595 x 35

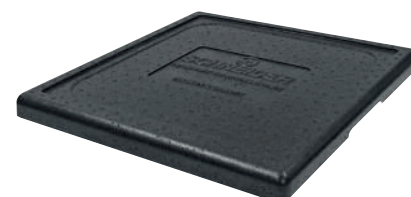

DE	TRANSPORTHILFE	ALU	PIZZA	S
EN	TRANSPORT ASSISTANCE			
IT	AIUTO AL TRASPORTO			
ES	AIUTO AL TRASPORTO			

- Passend für # 650240, 650330, 650395
- Geeignet für Pizza & Torte
- Mit Bodenlochung: 3 mm
- Suitable for # 650240, 650330, 650395
- Suitable for pizza & cake
- With perforated base: 3 mm

#	↗ mm	→ mm	↑ mm
690030	340	340	150





DE	KÜHLPLATTEN
EN	COOLING TRAYS
IT	VASSOIO RAFFREDDANTE
ES	BANDEJA REFRIGERADA



Material: Edelstahl

- Integrierte Kühlelemente fest verschlossen
- Bei – 20°C ca. 4 Stunden gefrieren

Material: stainless steel

- Integrated cooling elements firmly closed
- Freeze at – 20°C for approx. 4 hours



#		↗ mm	→ mm	↑ mm
281020	GN 1/1	530	325	45
281021	GN 1/2	325	265	45



DE	WÄRMEAKKUS
EN	HEAT PACKS
IT	ACCUMULATORI DI CALDO
ES	PLACAS DE CALOR



- Bei max. 85 °C für ca. 30 Minuten im Ofen oder Wasserbad erhitzen

- Heat at max. 85 °C for approx. 30 minutes in the oven or water bath



#	GN / cm	↔ mm	⚖ g
281030	1/1	530 x 325 x 30	4060
281031	1/2	325 x 265 x 30	2360
281032	1/4	265 x 162 x 30	1080
281033	40 x 60	600 x 400 x 28	5110

DE	KÜHLAKKUS „COLD“
EN	COOLING PACKS „COLD“
IT	PIASTRE EUTETTICHE „COLD“
ES	PLACAS EUTÉCTICAS „COLD“



- Platten horizontal und mindestens 24 Stunden vor dem Gebrauch in den Gefrierschrank legen
- Place plates horizontally in the freezer for at least 24 hours before use



1

#	GN / cm	↔ mm	g
281001	1/9	176 x 108 x 30	500
281002	1/4	265 x 162 x 30	1000
281003	1/3	325 x 176 x 30	1500
281016	1/2	265 x 325 x 32	2100
281004	1/1	530 x 325 x 30	3950
281005	40 x 60	600 x 400 x 28	5200
281017	20 x 14	200 x 140 x 20	450
281006	1/9	176 x 108 x 30	500
281007	1/4	265 x 162 x 30	1000
281008	1/3	325 x 176 x 30	1500
281018	1/2	265 x 325 x 32	2100
281009	1/1	530 x 325 x 30	3950
281010	40 x 60	600 x 400 x 28	5200
281040	20 x 14	200 x 140 x 20	450
281011	1/9	176 x 108 x 30	500
281012	1/4	265 x 162 x 30	1000
281013	1/3	325 x 176 x 30	1500
281041	1/2	265 x 325 x 32	2100
281014	1/1	530 x 325 x 30	3950
281015	40 x 60	600 x 400 x 28	5200
281042	20 x 14	200 x 140 x 20	450



GN 1/1

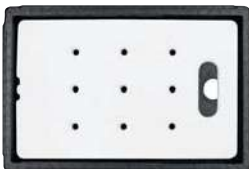

GN 1/2

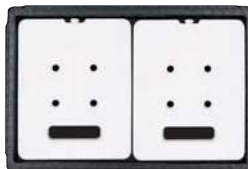

GN 1/3



GN 1/4



GN 1/9

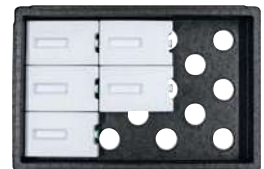

Gefriertemperatur der eutektischen Platte muss immer unter 6 °C der Schmelztemperatur der eutektischen Flüssigkeit liegen:

The freezing temperature of the eutectic plate must always be 6 °C below the melting temperature of the eutectic liquid:

	Einzufrieren bei / Freeze at	
	- 9° C	
	- 18° C	
	- 27° C	

- Verlängert die Temperaturbeständigkeit
- unterstützt die Lieferkette nach HACCP-Standard
- Nahezu unendlich wiederverwendbar
- Formstabil
- Nicht spülmaschineneignen

- Extends the temperature resistance
- Supports the supply chain according to HACCP standard
- Almost infinitely reusable
- Dimensionally stable
- Not dishwasher safe



DE	LEBENSMITTELBEHÄLTER / VORRATSBEHÄLTER – FAHRBAR	
EN	INGREDIENT STORAGE TROLLEY	
IT	CONTENITORE MOBILE DA STOCCAGGIO	
ES	CONTENEDOR DE INGREDIENTES CON RUEDAS	

Material: PP

- 4 Rollen
- Abgerundete Ecken
- Glatte Oberfläche für maximale Hygiene
- Deckel durchsichtig
- 2-teilig, inklusive Schaufel

Made of PP

- 4 wheels
- Rounded corners
- Smooth surface to allow spotless cleaning
- Transparent lid
- 2-pieces, including scoop

#	↔ mm	♻️ l
200890	333 x 743 x 711	81,0



DE	LEBENSMITTELBEHÄLTER / VORRATSBEHÄLTER / ZUTATENBEHÄLTER
EN	INGREDIENT STORAGE CONTAINERS
IT	CONTENITORI DA STOCCAGGIO
ES	CONTENEDORES DE INGREDIENTES

Material: PP

- Abgerundete Ecken
- Glatte Oberfläche um sauberes Reinigen zu gewährleisten
- Deckel durchsichtig

Made of PP

- Rounded corners
- Smooth surface to allow thorough cleaning
- Transparent lid

#	↔ mm	♻️ l
200891	310 x 375 x 215	8,0
200892	280 x 595 x 430	20,0
200893	480 x 630 x 430	40,0

DE	KÜBEL
EN	BUCKETS
IT	SECCHI
ES	CUBOS

Material: HDPE, weiß  
 • Mit zwei Griffen

Made of HDPE, white  
 • With two handles

#	↑ Ø mm	↓ Ø mm	↑ mm	↕ l
202000	390	310	410	35,0
202010	455	362	470	50,0
202020	482	390	570	75,0
202030	520	415	670	100,0

202005	Deckel für Kübel / Lid for bucket # 202000
202015	Deckel für Kübel / Lid for bucket # 202010
202025	Deckel für Kübel / Lid for bucket # 202020
202035	Deckel für Kübel / Lid for bucket # 202030



1

DE	FAHRGESTELL FÜR KÜBEL
EN	DOLLY FOR BUCKETS
IT	CARRELLO PER SECCHI
ES	CARRETILLA PARA CUBOS REDONDOS

Material: Edelstahl  
 • Verstellbar

Made of stainless steel  
 • Adjustable

#	für / for
202098	202000, 202010, 202020, 202030



DE	TEIGWANNEN RECHTECKIG
EN	DOUGH CONTAINERS RECTANGULAR
IT	CONTENITORI PER IMPASTO RETTANGOLARI
ES	CUBETAS RECTANGULARES PARA MASA

Material: HDPE, weiß  
 • Ohne Deckel

Made of HDPE, white  
 • Without lid

#	↔ mm	↑ mm	↕ l
200960	530 x 410 x 140	440 x 320 x 130	20,0
200962	440 x 320 x 155	395 x 275 x 150	12,0
200963	610 x 440 x 150	550 x 375 x 145	25,0



DE	TEIGWANNEN RUND
EN	DOUGH CONTAINERS ROUND
IT	CONTENITORI PER IMPASTO TONDI
ES	CUBETAS REDONDAS PARA MASA

Material: HDPE, weiß  
 • Ohne Deckel

Made of HDPE, white  
 • Without lid

#		Ø ↑ mm	↑ mm	↕ l
200970	mit Griff / with handle	450	185	14,0
200971	ohne Griff / without handle	480	170	19,0





DE	TEIGWANNE RECHTECKIG	
EN	DOUGH CONTAINER RECTANGULAR	
IT	CONTENITORI PER IMPASTO RETTANGOLARI	
ES	CUBETAS RECTANGULARES PARA MASA	

Material: PP, weiß

- Robuste und praktische Teigwanne mit zwei Griffen, ohne Deckel
- Ideal für Transportwagen 600 x 400 mm
- Stapelbar (mit Deckel # 202181)

Made of PP, white

- Robust and practical dough container with two handles, without lid
- Ideal for transport trolleys 600 x 400 mm
- Stackable (with lid # 202181)

#	↔ mm	↑ mm	↓ l
202180	600 x 400 x 82	500 x 300 x 77	13,0



DE	DECKEL FÜR TEIGWANNE RECHTECKIG	
EN	LID FOR DOUGH CONTAINER RECTANGULAR	
IT	COPERCHIO PER CONTENITORI PER IMPASTO RETTANGOLARI	
ES	TAPA DE LA CUBETAS RECTANGULARES PARA MASA	

Material: PP, weiß

- Beidseitig verwendbar
- Stapelbar

Made of PP, white

- Usable on both sides
- Stackable

#	↔ mm	für / for
202181	600 x 400	# 202180



DE	STAPELBEHÄLTER	
EN	STACKABLE CONTAINERS	
IT	CONTENITORI IMPILABILI	
ES	CONTENEDORES APILABLES	

Material: HDPE, weiß

- Ohne Deckel

Made of HDPE, white

- Without lid

#	↔ mm	↑ mm	↓ l
202200	570 x 415 x 290	455 x 355 x 285	50,0
202210	640 x 440 x 330	530 x 380 x 325	65,0
202220	740 x 460 x 360	610 x 400 x 355	90,0



DE	DECKEL FÜR STAPELBEHÄLTER	
EN	LID FOR STACKABLE CONTAINERS	
IT	COPERCHIO PER CONTENITORI IMPILABILI	
ES	TAPA PARA CONTENEDORES APILABLES	

Material: HDPE, weiß

Made of HDPE, white

#	↔ mm	für / for
202205	430 x 580	# 202200
202215	445 x 650	# 202210
202225	470 x 750	# 202220





DE	PIZZABALLENBOX / TEIGWANNE RECHTECKIG
EN	DOUGH CONTAINER RECTANGULAR
IT	CONTENITORE PER IMPASTO RETTANGOLARE
ES	CUBETAS RECTANGULARES PARA MASA

Material: PE, weiß

Made of PE, white

#	↔ mm	⏏ mm	♻ l
202170	600 x 400 x 75	565 x 365 x 70	14,0
202172	600 x 400 x 95	565 x 365 x 90	18,0
202173	600 x 400 x 130	565 x 365 x 120	24,0



DE	DECKEL FÜR PIZZABALLENBOX / TEIGWANNE
EN	LID FOR DOUGH CONTAINER
IT	COPERCHIO PER CONTENITORE IMPASTO
ES	TAPA DE LA CUBETA PARA MASA

Material: PE, weiß

Made of PE, white

#	↔ mm	für / for
202171	600 x 400	# 202170 / 202172 / 202173



DE	EIMER
EN	BUCKETS
IT	SECCHI
ES	CUBOS

Material: LDPE, weiß

Made of LDPE, white

- Schwere Qualität
- Mit Ausguss
- Metallbügel und Literskala

- Heavy quality
- With spout
- Metal handle and liter scale

#	∅ ↑ mm	∅ ↓ mm	↑ mm	♻ l
200830	280	193	300	10,0
200840	316	235	335	15,0



Material: LDPE, weiß

Made of LDPE, white

- Mit Ausguss
- Metallbügel und Literskala

- With spout
- Metal handle and liter scale



#	∅ ↑ mm	∅ ↓ mm	↑ mm	♻ l
200880	305	220	275	12,0
200881	320	230	285	15,0
200882	350	250	315	18,0



Material: Edelstahl

Made of stainless steel



- Flacher Boden
- Mit Skala (innen)

- Flat bottom
- With scale (inside)

#	∅ mm	↑ mm	♻ l
200850	300	250	10,0
200860	310	270	12,0
200870	325	310	15,0
200855	Deckel für Eimer / Lid for bucket # 200850		
200865	Deckel für Eimer / Lid for bucket # 200860		
200875	Deckel für Eimer / Lid for bucket # 200870		





DE	TRANSPORTWAGEN / REGALWAGEN	
EN	UTILITY RACK	
IT	CARRELLO PORTAVASSOI	
ES	CARRO PORTA BANDEJAS	

Material: Edelstahl, Rahmen aus Vierkantprofilen 25 x 25 mm; Höhe: 1,8 Meter

- **Blecheinschub längs**
- Blechauflage: 30 mm; Materialstärke: 1 mm
- **Selbstmontage**, inkl. 6 Schrauben und Schlüssel
- Lenkrollen aus Thermoplast Ø: 100 mm
- 2 Rollen feststellbar

Made of stainless steel, frame made of square profiles 25 x 25 mm; height: 1.8 m

- **Tray insertion lengthwise**
- Sheet support: 30 mm, thickness 1 mm
- **Self-assembly**, incl. 6 screws and key
- Thermoplastic wheels Ø: 100 mm
- 2 lockable wheels

• Abstand: 79 mm

• Distance: 79 mm

#	↗ mm	→ mm	↑ mm	
385010	600	400	1800	20
385030	530	325	1800	20

GN 1/1

• Abstand: 88 mm

• Distance: 88 mm

385040	600	400	1800	18
385050	530	325	1800	18

GN 1/1

• Abstand: 106 mm

• Distance: 106 mm

NEW

385000	600	400	1800	15
--------	-----	-----	------	----

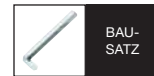

DE	UNIVERSAL TRANSPORTWAGEN	
EN	UTILITY RACK	
IT	CARRELLO PORTAVASSOI	
ES	CARRO PORTA BANDEJAS	

- Material: Edelstahl
- Verschweißte Ausführung
  - **Für Bleche 80 x 60 cm, 78 x 58 cm und 60 x 40 cm**
  - Mit Winkelaufkantung hinten
  - Materialstärke: 1 mm
  - Rahmen aus Vierkantprofilen 25 x 25 mm
  - Fahrbar auf Lenkrollen
  - 2 Rollen feststellbar

- Made of stainless steel
- Welded type
  - **For trays 80 x 60 cm, 78 x 58 cm and 60 x 40 cm**
  - With angle upstand rear
  - Material thickness: 1 mm
  - Frame made of square profiles 25 x 25 mm
  - Mobile on swivel castors
  - 2 lockable wheels

#	↗ mm	→ mm	↑ mm	
385180	800	660	1800	20

 Transportwagen: Nicht für Temperaturen unter 0 °C geeignet!  
Utility rack: Not suitable for temperatures below 0 °C!

DE	TRANSPORTWAGEN / REGALWAGEN
EN	UTILITY RACK 
IT	CARRELLO PORTAVASSOI
ES	CARRO PORTA BANDEJAS

Material: Edelstahl, Rahmen aus Vierkantprofilen 25 x 25 mm

- Verschweißte Ausführung
- Blechauflage: 30 mm; Materialstärke: 1 mm
- Abstand: 87 mm
- Lenkrollen aus Thermoplast Ø: 100 mm
- 2 Rollen feststellbar

Made of stainless steel, frame made of square profiles 25 x 25 mm

- Welded type
- Sheet support: 30 mm, thickness 1 mm
- Distance: 87 mm
- Thermoplastic wheels Ø: 100 mm
- 2 lockable wheels

**Blecheinschub längs**

**Tray insertion lengthwise**

#	↗ mm	→ mm	↑ mm	
385100	600	400	1800	18
385120	530	325	1800	18

**Blecheinschub quer**

**Tray insertion crosswise**

#	↗ mm	→ mm	↑ mm	
385015	600	400	1800	18
385035	530	325	1800	18

GN 1/1



GN 1/1



DE	TRANSPORTWAGEN / REGALWAGEN – Z-FORM
EN	UTILITY RACK – Z-SHAPE 
IT	CARRELLO PORTAVASSOI - FORMA A Z
ES	CARRO PORTA BANDEJAS - FORMA Z

Material: Edelstahl, Rahmen aus Vierkantprofilen 25 x 25 mm

- Verschweißte Ausführung
- **Blecheinschub längs**
- Blechauflage: 30 mm, Materialstärke 1 mm
- Abstand: 87 mm
- Z-Form ermöglicht das Zusammenschieben mehrerer Wagen, optimal für eine platzsparende Aufbewahrung
- Lenkrollen aus Thermoplast Ø 80 mm
- 2 Rollen feststellbar

Made of stainless steel, frame made of square profiles 25 x 25 mm

- Welded type
- **Tray insertion lengthwise**
- Sheet support: 30 mm, thickness 1 mm
- Distance: 87 mm
- Z-shape allows several trolleys to be pushed together, optimal for space-saving storage
- Thermoplastic wheels Ø 80 mm
- 2 lockable wheels

#	↗ mm	→ mm	↑ mm	
385200	600	400	1770	18
385205	530	325	1770	18

GN 1/1





DE	KLIMASCHUTZHAUBE / GITTERHAUBE
EN	ZIPPERED PLASTIC COVER
IT	COPRICARRELLO IN PLASTICA CON CERNIERA
ES	CUBRE CARRO DE PLASTICO

- |                                     |                                    |
|-------------------------------------|------------------------------------|
| Material: LDPE                      | Made of LDPE                       |
| • Mit Reißverschluss,               | • With zipper                      |
| • Für Transport- und Stikkenwagen   | • Weight: ca. 300 g/m <sup>2</sup> |
| • Gewicht: ca. 300 g/m <sup>2</sup> |                                    |

#	für / for mm		↔ mm
391950	580 x 780	längs / lengthwise	1650 x 720 x 860
391951	570 x 980	längs / lengthwise	1650 x 720 x 1070
391952	600 x 400	quer / crosswise	1650 x 690 x 450
391953	600 x 400	längs / lengthwise	1650 x 490 x 640
391954	GN 1/1 – 530 x 325	längs / lengthwise	1650 x 425 x 570



DE	KLIMASCHUTZHAUBE – EINWEG
EN	PLASTIC COVER – DISPOSABLE
IT	COPRICARRELLO IN PLASTICA - USA E GETTA
ES	CUBRE CARRO DE PLASTICO – DESECHABLE

- |                        |                    |
|------------------------|--------------------|
| Material: PE           | Made of PE         |
| • Materialstärke: 14 µ | • Thickness: 14 µ  |
| • Für Transportwagen   | • For utility rack |

#	für / for mm	Zuschnitt / blank cut	↗ mm	→ mm	↑ mm
391960*	GN 2/1 – 650 x 530	100	770	750	1900
391961	GN 1/1 – 600 x 400	100	650	500	1850



#	für / for mm	Rolle / roll	↗ mm	→ mm	↑ mm
391970*	GN 1/1 – 530 x 325	100	770	630	1800
391971*	GN 2/1 – 650 x 530	100	770	750	1900
391972	600 x 400	100	650	500	1850

**i** \* für zwei Transportwagen nebeneinander / for two utility racks to each other

DE	ABROLLGERÄT
EN	DISPENSER
IT	DISTRIBUTORE
ES	DISPENSADOR

- |               |             |
|---------------|-------------|
| Material: PVC | Made of PVC |
|---------------|-------------|

#	↔ mm
391980	890 x 140 x 100



DE	TRANSPORTWAGEN / REGALWAGEN
EN	UTILITY RACK
IT	CARRELLO PORTAVASSOI
ES	CARRO PORTA BANDEJAS



Material: Edelstahl

- Blecheinschub längs
- Geschlossene, verschweißte Ausführung
- Lenkrollen aus Thermoplast Ø: 100 mm
- Blechauflage: 30 mm; Materialstärke: 1 mm

Made of stainless steel

- Tray insertion lengthwise
- Closed, welded type
- Thermoplastic wheels Ø: 100 mm
- Sheet support: 30 mm, thickness 1 mm

#		für / for mm	↔ mm
385029	15	600 x 400	470 x 650 x 1420
385009	15	530 x 325	395 x 580 x 1420

GN  
1/1

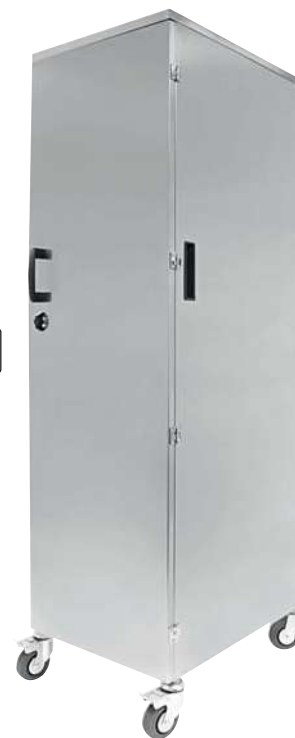

1



DE	TÜRSCHLOSS
EN	DOOR LOCK
IT	CHIUSURA DELLA PORTA
ES	CERRADURA DE PUERTA

- Zum Nachrüsten
- Inklusive 2 Schlüssel

- For retrofitting
- 2 keys included

#	1 Set – für / for #
385099	385029 + 385009



① **Stikken- und Ofenwagen für alle gängigen Öfen (MIWE, W&P, REVENT, etc.) sowie Frosterwagen auf Anfrage.**

**Mobile oven racks for all common ovens (MIWE, W&P, REVENT, etc.) as well as mobile freezer racks on request.**

① **Transportwagen: Nicht für Temperaturen unter 0 °C geeignet!**  
Utility rack: Not suitable for temperatures below 0 °C!

DE	GLASIERTISCH / REGALWAGEN	
EN	GLAZING TABLE / UTILITY RACK	
IT	CARRELLO PORTAVASSOI/PIANO PER GLASSATURA	
ES	CARRO PORTA BANDEJAS / MESA PARA GLASEAR BOLLERÍA	

Material: Edelstahl

- Verschweißte Ausführung
- Abstand der Etagen: ca. 7 cm
- Für Bleche 40 x 60 cm
- Lenkrollen aus Thermoplast Ø 100 mm
- 2 Rollen feststellbar

Made of stainless steel

- Welded type
- Distance between the supports: approx. 7 cm
- For trays 40 x 60 cm
- Thermoplastic wheels castors Ø 100 mm
- 2 lockable wheel

#	↗ mm	→ mm	↑ mm	≡	
385500	665	400	900	10	
385510	605	465	900	10	

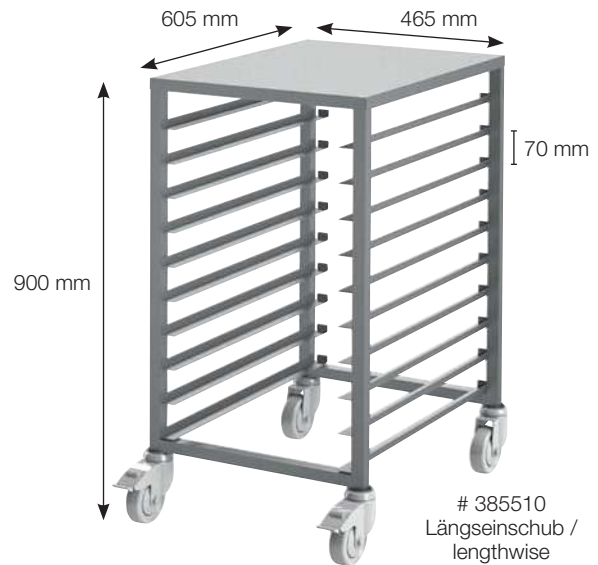
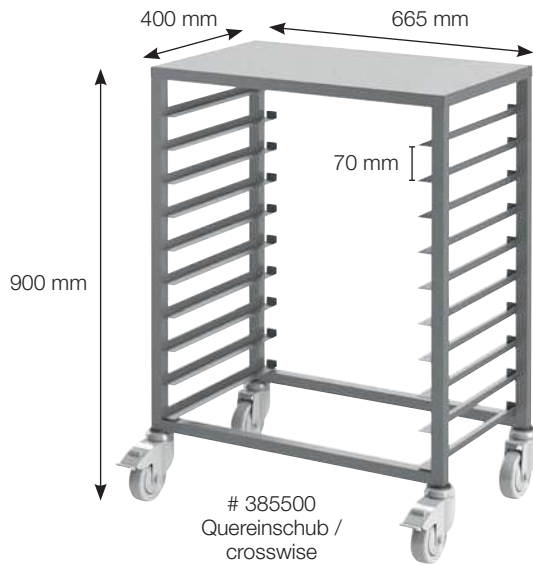

DE	SERVIERWAGEN	
EN	SERVICE TROLLEY	
IT	CARRELLO DI SERVIZIO	
ES	CARRO DE SERVICIO	

Material: Edelstahl

- Verschweißte Ausführung
- Lenkrollen aus Thermoplast Ø 100 mm
- 2 Rollen feststellbar

Made of stainless steel

- Welded type
- Thermoplastic wheels castors Ø 100 mm
- 2 lockable wheel

#	↗ mm	→ mm	↑ mm	≡	
385550	845	504	945	2	
385551	845	504	945	3	



DE	BEHÄLTERWAGEN /TEIGBEHÄLTERWAGEN	
EN	CONTAINER TROLLEY	
IT	CARRELLI PORTACONTENITORI	
ES	CARRO PARA CONTENEDORES	

- Für 8 Behälter á 25,0 L (# 200963)
- Verschweißte Ausführung
- Deckel fest verschweiß
- **Ohne Behälter**
- For 8 25.0 l containers (# 200963)
- Welded type
- Cover fixed welded
- **Without containers**

#	↗ mm	→ mm	↑ mm	
202095	670	470	1760	



1

DE	TEIGWANNEN RECHTECKIG
EN	DOUGH CONTAINERS RECTANGULAR
IT	CONTENITORI PER IMPASTO, RETTANGOLARI
ES	CONTENEDORES RECTANGULARES PARA MASA

Material: HDPE, weiß      Made of HDPE, white

#	⊞ l	↗ mm	→ mm	↑ mm	
200963	25	610	440	150	



DE	WAGEN FÜR FAHRGESTELLE & TORTENRINGE	
EN	RACK FOR DOLLYS & TART RINGS	
IT	PORTA CARRELLI & ANELLI PER TORTE	
ES	BASTIDOR PARA CARRETILLAS & AROS PARA TARTAS	

- Material: Edelstahl      Made of stainless steel
- Verschweißte Ausführung
  - Mit je 2 Lenk- und 2 Bockrollen
  - Welded type
  - 2 fixed and 2 steering castors

#	↗ mm	→ mm	↑ mm	
202089	750	470	1503	

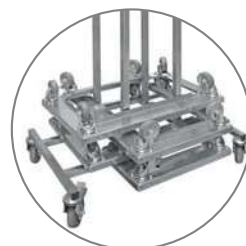
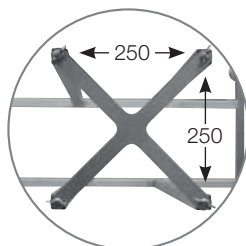
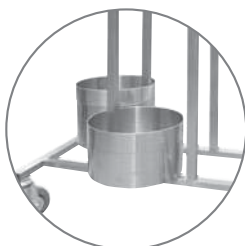

2in1

# BACKBLECHE / BAKING TRAYS



## Aluminium

- Robust
- Stapelbar
- Einfach zu reinigen
- Hohe Stabilität
- Langlebig

- Robust
- Stackable
- Easy to clean
- High stability
- Durable



## Silikon-Beschichtung

- Antihftbeschichtung auf Silikonbasis
- Farbe: rot
- Hohe Lebensdauer
- Einsetzbar bis maximal + 260 °C

- Silicone-based non-stick coating
- Color: red
- High durability
- Can be used up to a maximum of + 260 °C



## TYNECK-Beschichtung

- Thermoplastische Beschichtung
- Farbe: schwarz
- Sehr lange Lebensdauer
- Laugenresistent
- Hohe Antihft-Eigenschaft
- Sehr robuste Oberfläche
- Schnitt- und kratzfest (bei handelsüblichem Gebrauch und Umgang)
- Einsetzbar bis maximal + 260 °C

- Thermoplastic coating
- Color: black
- Very high durability
- Resistant to alkalis / lye
- High non-stick property
- Very robust surface
- Cut and scratch resistant (for normal commercial use and handling)
- Can be used up to a maximum of + 260 °C



## TYNECK RED-Beschichtung

- Mehrschicht-Antihftsystembeschichtung
- Farbe: rot
- Sehr lange Lebensdauer
- Lauge- und säurebeständig
- Zuckerbeständig
- Sehr hohe Antihft-Eigenschaft
- Sehr robuste Oberfläche
- Schnitt- und kratzfest (bei handelsüblichem Gebrauch und Umgang)
- Einsetzbar bis maximal + 260 °C

- Multi-layer system non stick coating
- Color: red
- Very high durability
- Resistant to alkalis / lye and acid
- Resistant to sugar
- High non-stick property
- Very robust surface
- Cut and scratch resistant (for normal commercial use and handling)
- Can be used up to a maximum of + 260 °C

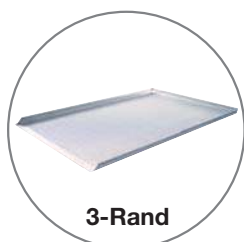



DE	BACKBLECHE / LOCHBLECHE – ALUMINIUM
EN	BAKING TRAYS – MADE OF ALUMINIUM
IT	TEGLIE IN ALLUMINIO
ES	BANDEJAS PARA HORNO DE ALUMINIO



mit und ohne Lochung /  
with or without perforation

	↔ mm		#	⊙ mm	⊥ mm		↑ mm	
	530 x 325	<b>GN 1/1</b> 4 Seiten 45° / 4 sides 45°	381050	–	1,5	unbeschichtet/ uncoated	10	
	530 x 325	<b>GN 1/1</b> 4 Seiten 45° / 4 sides 45°	381051	3	1,5	unbeschichtet/ uncoated	10	
	530 x 325	<b>GN 1/1</b> 4 Seiten gezogen / 4 sides deep-drawn	381057	3	1,5	unbeschichtet/ uncoated	10	
	354 x 325	<b>GN 2/3</b> 4 Seiten 45° / 4 sides 45°	381060	3	1,5	unbeschichtet/ uncoated	10	
	325 x 530	<b>GN 1/1</b> 4 Seiten, Ränder 90°, verschweißt 4 sides 90°, welded	381063	–	2,0	unbeschichtet/ uncoated	15	
	530 x 325	<b>GN 1/1</b> 4 Seiten 45° / 4 sides 45°	381052	3	1,5	Silikon / silicone	10	
	650 x 530	<b>GN 2/1</b> 4 Seiten 45° / 4 sides 45°	381054	3	1,5	Silikon / silicone	10	
	354 x 325	<b>GN 2/3</b> 4 Seiten 45° / 4 sides 45°	381058	3	1,5	Silikon / silicone	10	
	530 x 325	<b>GN 1/1</b> 4 Seiten 45° / 4 sides 45°	382000	–	1,5	TYNECK	10	
	530 x 325	<b>GN 1/1</b> 4 Seiten gezogen / 4 sides deep-drawn	382030	–	1,5	TYNECK	10	
	354 x 325	<b>GN 2/3</b> 4 Seiten 45° / 4 sides 45°	382020	–	1,5	TYNECK	10	
	354 x 325	<b>GN 2/3</b> 4 Seiten 45° / 4 sides 45°	382040	3	1,5	TYNECK	10	
	530 x 325	<b>GN 1/1</b> 4 Seiten 45° / 4 sides 45°	382010	3	1,5	TYNECK	10	

2

Pizzableche finden Sie auf Seite 348/349. / You can find pizza trays on page 348/349.

mit und ohne Lochung /  
with or without perforation

DE	BACKBLECHE / LOCHBLECHE
EN	BAKING TRAYS
IT	TEGLIE
ES	BANDEJAS PARA HORNO



Material: Aluminium (AlMn)

Made of aluminium

	↔ mm		#	⊙ mm	⊥ mm		↑ mm	
	600 x 400	4 Seiten 45° / 4 sides 45°	381100	3	1,5	unbeschichtet / uncoated	10	
	600 x 400	4 Seiten 45° / 4 sides 45°	381106	-	1,5	unbeschichtet / uncoated	10	
	600 x 400	3 Seiten 90° / 3 sides 90° 1 kurze Seite offen 45° / 1 short side open	381101	3	1,5	unbeschichtet / uncoated	20	
	600 x 400	4 Seiten, Ränder 90°, verschweißt 4 sides 90°	381110	-	1,5	unbeschichtet / uncoated	20	
	600 x 400	4 Seiten, Ränder 90°, verschweißt 4 sides 90°, welded	381061	3	1,5	unbeschichtet / uncoated	20	
	600 x 400	4 Seiten gezogen / 4 sides deep-drawn	381108	3	1,5	unbeschichtet / uncoated	10	
	600 x 400	3 Seiten 90° / 3 sides 90° 1 kurze Seite offen 45° / 1 short side open	381109	-	1,5	unbeschichtet / uncoated	10	
	600 x 400	4 Seiten 45° / 4 sides 45°	381102	3	1,5	Silikon / silicone	10	
	600 x 400	4 Seiten 45° / 4 sides 45°	382100	-	1,5	TYNECK	10	
	600 x 400	4 Seiten 45° / 4 sides 45°	382110	3	1,5	TYNECK	10	

Material: Edelstahl

Made of stainless steel

	600 x 400	4 Seiten 45° / 4 sides 45°	383110	3	1,5	TYNECK RED	10	
--	-----------	-------------------------------	--------	---	-----	------------	----	--

DE	BACKBLECHE / LOCHBLECHE
EN	BAKING TRAYS
IT	TEGLIE
ES	BANDEJAS PARA HORNO



mit und ohne Lochung /  
with or without perforation

Material: Aluminium (AlMn)

Made of aluminium

	↔ mm		#	⊙ mm	⊥ mm		↑ mm	
	400 x 300	4 Seiten 45° / 4 sides 45°	<b>NEW</b> 381020	–	1,5	unbeschichtet/ uncoated	10	
	400 x 300	4 Seiten 45° / 4 sides 45°	<b>NEW</b> 381021	3	1,5	unbeschichtet/ uncoated	10	
	400 x 300	4 Seiten 45° / 4 sides 45°	<b>NEW</b> 381022	3	1,5	Silikon / silicone	10	
	780 x 580	2 Seiten 70° / 2 sides 70° lange Seiten offen / long sides open	381005	3	2,0	unbeschichtet/ uncoated	10	
	780 x 580	3 Seiten 90° / 3 sides 90° 1 kurze Seite offen / 1 short side open	381006	3	1,5	unbeschichtet/ uncoated	25	
	780 x 580	3 Seiten 90° / 3 sides 90° 1 kurze Seite offen / 1 short side open	381007	3	2,0	unbeschichtet/ uncoated	25	
	780 x 580	2 Seiten 70° / 2 sides 70° lange Seiten offen / long sides open	381200	–	2,0	unbeschichtet/ uncoated	10	
	780 x 580	3 Seiten 90° / 3 sides 90° 1 kurze Seite offen / 1 short side open	381201	–	1,5	unbeschichtet/ uncoated	25	
	780 x 580	2 kurze Seiten 45° / 2 short sides 45° lange Seiten offen / long sides open	381127	3	2,0	unbeschichtet/ uncoated	10	
	980 x 580	3 Seiten 90° / 3 sides 90° 1 kurze Seite offen / 1 short side open	381000	3	1,5	unbeschichtet/ uncoated	25	

Material: Edelstahl

Made of stainless steel

	780 x 580	4 Seiten 45° / 4 sides 45°	383200	3	1,5	TYNECK RED	10	
--	-----------	-------------------------------	--------	---	-----	------------	----	--



DE	BACKBLECHE / KONVEKTOMATENBLECHE	
EN	BAKING TRAYS	
IT	TEGLIE	
ES	BANDEJAS PARA HORNO	

Material: Stahlblech, Granit-Emaile

Made of steel, enamel granite

- Beidseitig beschichtet
- Materialstärke: 1,0 mm

- Coated on both sides
- Thickness: 1.0 mm

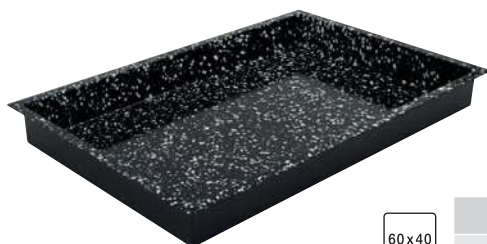

600 x 400 – Ausführung: 4 Seiten 90°

600 x 400 – Type: 4 sides 90°

#	↗ mm	→ mm	↑ mm
382562	600	400	60

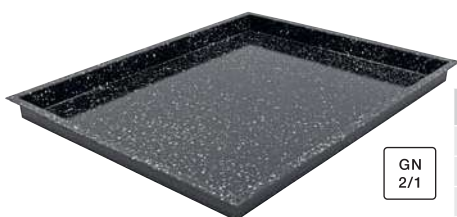

GN 2/1 – Ausführung: 4 Seiten 90°

GN 2/1 – Type: 4 sides 90°

#	↗ mm	→ mm	↑ mm
382500	530	650	20
382501	530	650	40
382502	530	650	60

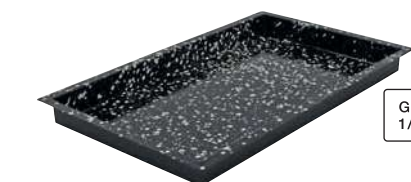

GN 1/1 – Ausführung: 4 Seiten 90°

GN 1/1 – Type: 4 sides 90°

#	↗ mm	→ mm	↑ mm
382510	530	325	20
382511	530	325	40
382512	530	325	60

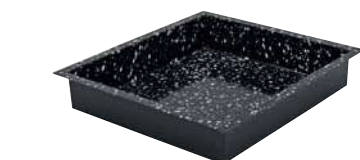

GN 2/3 – Ausführung: 4 Seiten 90°

GN 2/3 – Type: 4 sides 90°

#	↗ mm	→ mm	↑ mm
382520	354	325	20
382521	354	325	40
382522	354	325	60

DE	GN-BACKBLECHE / KONVEKTOMATENBLECHE
EN	GN-BAKING TRAYS
IT	TEGLIE GN
ES	BANDEJAS PARA HORNO GN



Material: Stahlblech, Emaille, schwarz  
 • Beidseitig beschichtet

Made of steel, enamel, black  
 • Coated on both sides

#	↗ mm	→ mm	↑ mm	⏊ mm	⏏ l
382530	530	325	20	0,8	2,5
382531	530	325	40	0,8	5,3
382532	530	325	65	0,8	8,8
382533	325	265	40	0,8	2,5
382534	325	265	65	0,8	4,0
382535	325	176	40	0,8	1,8
382536	325	176	65	0,8	2,4



2

DE	GN-BEHÄLTER AUS EDELSTAHL
EN	GN-CONTAINERS MADE OF STAINLESS STEEL
IT	CONTENITORI GN IN ACCIAIO INOX
ES	CONTENEDORES GASTRONORM ACERO INOXIDABLE

SST

#	GN	↑ mm	⏏
530200	1/1	20	1,9
530201	1/1	40	5,4
530202	1/1	65	8,7
530203	1/1	100	13,0



DE	GRILLROSTE
EN	GRIDS
IT	GRIGLIE
ES	REJILLAS

SST

#		↗ mm	→ mm	≡	Ø mm	Drähte Ø mm / wire Ø mm
156110		600	400	2	6	24 / 3
156111	GN 1/1	530	325	1	7	20 / 3
156112	GN 2/3	354	325	1	5	15 / 2
156113	GN 2/1	650	530	3	6	32 / 2

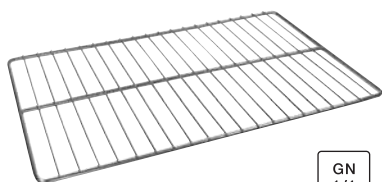
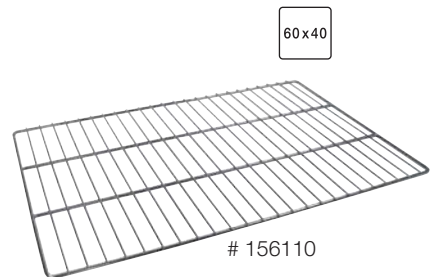

# 156111

GN 1/1

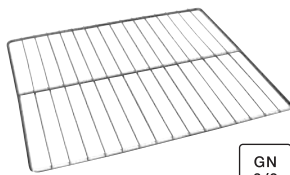

# 156112

GN 2/3

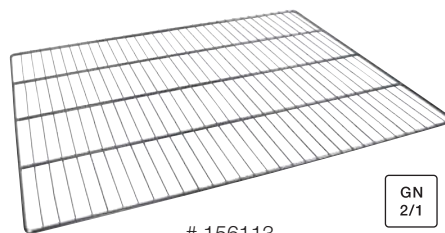

# 156113

GN 2/1



DE	SCHNITTKUCHENBLECHE MIT VORSATZSCHIENE
EN	CAKE DISPLAY SHEET WITH JOINT BAR
IT	TEGLIE PER TORTE CON BORDO REMOVIBILE
ES	BANDEJAS CON LATERAL DESMONTABLE

**Material: Aluminium**  
 • Materialstärke: 1,5 mm

**Made of aluminium**  
 • Thickness: 1.5 mm

#	↗ mm	→ mm	↑ mm	
995810	580	100	50	
995820	580	200	50	
995840	580	400	50	
995830	300	200	50	



**Ersatzschienen  
 Aluminium**

**Replacement joint bars  
 Aluminium**

#	→ mm	für / for #	
995811	100	995810	
995821	200	995820	
995841	400	995840	

**Material: Edelstahl**  
 • Materialstärke: 1 mm

**Made of stainless steel**  
 • Thickness: 1 mm

#	↗ mm	→ mm	↑ mm	
997810	580	100	50	
997820	580	200	50	
997840	580	400	50	



**Ersatzschienen  
 Edelstahl**

**Replacement joint bars  
 Stainless steel**

#	→ mm	für / for #	
997811	100	997810	
997821	200	997820	
997841	400	997840	



DE	SCHNITTKUCHENBLECHE MIT VORSATZSCHIENE
EN	CAKE DISPLAY SHEET WITH JOINT BAR
IT	TEGLIE PER TORTE CON BORDO REMOVIBILE
ES	BANDEJAS CON LATERAL DESMONTABLE

**GN 1/1 mit Vorsatzschiene**

- Innenabmessungen: 520 x 290 x 50 mm
- Außenabmessungen: 535 x 325 x 50 mm

**GN 1/1 with joint bar**

- Dimensions inside: 520 x 290 x 50 mm
- Dimensions outside: 535 x 325 x 50 mm



GN 1/1

2

#		
994860	<b>Edelstahl</b> / stainless steel	
995860	<b>Aluminium</b> / aluminium	



DE	BACKBLECHVORSETZER
EN	JOINT BAR, ADJUSTABLE
IT	SPONDA REGOLABILE
ES	BARRA AJUSTABLE

- Material: Edelstahl
- Mit 2 Klammern

- Made of stainless steel
- With 2 clamps

#	Ausführung	↔ mm
997899	Feder / Spring	340 min. / 615 max
997890	Klammer / Clamp	340 min. / 640 max



DE	SCHNITTKUCHEN – BODENBLECH UND BACKRAHMEN IM SET
EN	CAKE DISPLAY – BASE PLATE AND BAKING FRAME IN THE SET
IT	KIT DI TEGLIA PER TORTA CON FONDO E TELAIO SEPARATI
ES	JUEGO DE PLACA BASE Y MARCO PARA HORNEAR

**Material: Aluminium**

- **2-teilig**
- Materialstärke: Boden mit Griff: 1,5 mm, Rahmen: 2,0 mm

**Made of aluminium**

- **2-pieces**
- Thickness: base with handle: 1.5 mm, frame: 2.0 mm



#	↗ mm	→ mm	↑ mm
995870	580	100	50
995880	580	200	50
995890	580	400	50

DE	RAHMEN FÜR SCHNITTKUCHENBLECH	NICHT zum Backen geeignet! NOT for baking!
EN	FRAME FOR CAKE DISPLAY SHEET	
IT	BASE PER TEGLIE PORTA TORTE	
ES	CONTENEDORES DE BANDEJAS PARA TORTA	

- |                               |                            |
|-------------------------------|----------------------------|
| Material: Polystyrol, schwarz | Made of polystyrene, black |
| • Genarbt                     | • Surface grained          |
| • Eine kurze Seite offen      | • One short side open      |



#	für / for	→ mm	↑ mm	↓ mm	
227577	995810 + 997810	115	55	590	
227578	995820 + 997820	215	55	590	



DE	PRÄSENTIER-STÄNDER / SCHNITTKUCHENBRÜCKE
EN	DISPLAY RISER FOR SLICED CAKES
IT	ALZATA ESPOSITORE PER TORTE A FETTE
ES	SOPORTE PARA REBANADAS DE PASTELES

- |                              |                              |
|------------------------------|------------------------------|
| Material: Acryl, transparent | Made of acrylic, transparent |
|------------------------------|------------------------------|



#	für / for	→ mm	↑ mm	↓ mm	
227575	995810 + 997810	106	80	70	
227576	995820 + 997820	206	80	70	

DE	GASTRO-BLECH UNIVERSAL	
EN	GASTRO-TRAY UNIVERSAL	
IT	VASSOIO DA FORNO GASTRO UNIVERSAL	
ES	BANDEJA DE COCCIÓN GASTRO UNIVERSAL	

- |   |  |
|---|--|
| Material: Aluminium                               | Made of aluminium                                |
| • Für Spiegeleier, Omeletts, Tortillas, Hamburger | • For fried eggs, omelets, tortillas, hamburgers |
| • Mit TYNECK-Beschichtung                         | • With TYNECK-coating                            |
| • 6 Mulden  | • 6 cavities                                     |



GN  
1/1

#	↔ mm	Ø mm	
382325	325 x 530	120	



DE	BAGUETTEBLECHE
EN	BAGUETTE TRAYS
IT	TEGLIE PER BAGUETTE
ES	BANDEJAS PARA BAGUETTES



**Ausführung: offener Rand – längs**

- Material: Aluminium
- Mit PTFE-Beschichtung, schwarz
- Perforation: 3 mm
- Runde Wellen

**Design: open edge – long side**

- Made of aluminium
- With PTFE-coating, black
- Perforation: 3 mm
- Round waves

#	↔ mm	↓ mm	Mulden / Cavities
381430	600 x 400 x 20	1,5	5
381432	530 x 325 x 20	1,5	4



2



DE	BACKTRENNPAPIERE “RONDEN” UND “RINGREIN”
EN	BAKING RELEASE PAPERS “RONDEN” (DISCS) AND “RINGREIN”
IT	CARTA DA FORNO, DISCHI E NASTRI
ES	PAPEL DE HORNO, CINTAS Y HOJAS REDONDAS

- Gebleicht
- Beidseitig silikonisiert
- Mehrmals verwendbar

- Bleached
- Siliconized on both sides
- Multiple bakes

#	Ø mm	
101007	70 mm x 400 m	1

#	Ø mm	
101006	180	500
101005	200	500
101011	240	500
101001	260	500
101002	280	500
101003	300	500
101004	330	500
101000	350	500

# 101007



Einfache Entnahme aus dem Karton / Easy removal



DE	BACKTRENNPAPIERE
EN	BAKING RELEASE PAPERS
IT	CARTA DA FORNO
ES	PAPEL DE HORNO SILICONADO

- Echtpergament
- Gebleicht
- Beidseitig silikonisiert
- Mehrmals verwendbar
- Hitzebeständig bis zu 290 °C
- Hohe Fettdichte
- Geeignet für alle Gebäckarten

- Pure vegetable parchment
- Bleached
- Siliconized on both sides
- Reusable
- Heat resistant up to 290 °C (554 °F)
- High grease density
- Suitable for all types of pastry



**“NON PLUS ULTRA”**

**“NON PLUS ULTRA”**

#	↔ mm x m	⚖ g/m <sup>2</sup>	🛒
101040	400 x 200	45	6
101043	430 x 200	45	6
101045	450 x 200	45	6
101050	500 x 200	45	6
101057	570 x 200	45	6

#	↔ mm	⚖ g/m <sup>2</sup>	🛒
101100	400 x 600	45	500
101120	500 x 700	45	500
101140	570 x 780	45	500

**“UNIVERSAL PLUS”  
Speziell für Laugenprodukte**

**“UNIVERSAL PLUS”  
Especially for lyed baking products  
including “pretzels”**

#	↔ mm	⚖ g/m <sup>2</sup>	🛒
109100	400 x 600	42	500
109140	570 x 780	42	500



Sonderformate auf Anfrage. / Special sizes upon request.

DE	BACKTRENNPAPIERE
EN	BAKING RELEASE PAPERS
IT	CARTA DA FORNO
ES	PAPEL DE HORNO SILICONADO

- Pergamentersatz
- Gebleicht
- Beidseitig silikonisiert
- Mehrmals verwendbar
- Greaseproof
- Bleached
- Two sides siliconized
- Multiple bakes

“SUPER EXTRA”

“SUPER EXTRA”

#	↔ mm x m	⚖ g/m <sup>2</sup>	🛒
103040	400 x 200	41	6
103043	430 x 200	41	6
103045	450 x 200	41	6
103050	500 x 200	41	6
103057	570 x 200	41	6

#	↔ mm x mm	⚖ g/m <sup>2</sup>	🛒
103079	340 x 430	41	500
103001	390 x 590	41	500
103100	400 x 600	41	500
103141	500 x 700	41	500
103140	570 x 780	41	500
103150	570 x 980	41	500

103032	320 x 530	<b>GN 1/1</b>	41	500
103078	520 x 640	<b>GN 2/1</b>	41	500



GN 1/1

GN 2/1

“UNIVERSAL”  
Speziell für Laugenprodukte

“UNIVERSAL”  
Especially for lyed baking products including “pretzels”

#	↔ mm x mm	⚖ g/m <sup>2</sup>	🛒
106152	400 x 600	41	500
106140	570 x 780	41	500



DE	PERGAMENTERSATZ
EN	GREASEPROOF PAPER
IT	CARTA PERGAMINO
ES	HOJAS DE PAPEL PERGAMINO

- Gebleicht
- Unbeschichtet
- Zum Abdecken von Teiglingen oder als Einlegepapier für Brotkörbe verwendbar
- Bleached
- Uncoated
- To cover dough or usable as inlay for baskets

#	↔ mm x mm	⚖ g/m <sup>2</sup>	🛒 kg
111300	380 x 580	45	10
111400	360 x 560	41	12,5
111410	375 x 500	49	12,5
111420	250 x 375	49	12,5
111430	500 x 750	49	12,5

#	↔ mm	⚖ g/m <sup>2</sup>	🛒 kg
111440	300	49	9
111441	400	49	12
111442	500	49	15
111443	600	49	18



📌 Sonderformate auf Anfrage. / Special sizes upon request.



DE	FAHRGESTELL FÜR BACKTRENNPAPIER
EN	TROLLEY FOR BAKING RELEASE PAPERS
IT	CARRELLO PER CARTA DA FORNO
ES	CARRETILO PARA PAPEL DE HORNO

Material: Edelstahl  
 • Inklusive 4 Rollen  
 • Für je 1000 Blatt

Made of stainless steel  
 • Including 4 wheels  
 • For 1000 sheets



#	↖ mm	→ mm	↓ mm	↑ mm
202090	400 x 600	500	370	730
202091	570 x 780	650	370	920



# 159150 + 159160



# 159240 + 159250 + 159260



# 159350 + 159360

DE	ABREISSGERÄTE
EN	TEAR-OFF DISPENSERS
IT	PORTAROTOLI DA TAVOLO
ES	SOPORTES PARA ROLLOS DE PAPEL SILICONADO

• Praktische Einhandbedienung dank hoher Standfestigkeit  
 • Lackierter Stahlprofilrahmen  
 • Glatte Schiene für Papier / Folienrollen von 30 bis 100 cm Breite und 22 cm Durchmesser, max. 20 kg

• Practical single-hand operation thanks to highly stable design  
 • Lacquered steel profile frame  
 • Smooth bar for paper / film rolls measuring from 30 to 100 cm in width and 22 cm in diameter, max. 20 kg

#	→ mm	
159150	500	Tisch, waagrecht / table, horizontal
159160	600	Tisch, waagrecht / table, horizontal
159240	400	Wand, waagrecht / wall, horizontal
159250	500	Wand, waagrecht / wall, horizontal
159260	600	Wand, waagrecht / wall, horizontal
159350	500	Tisch, senkrecht / table, vertical
159360	600	Tisch, senkrecht / table, vertical
159450	500	Untertisch, waagrecht /
159460	600	under table, horizontal



# 159450 + 159460

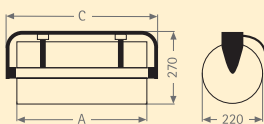

Untertisch, waagrecht / under table, horizontal

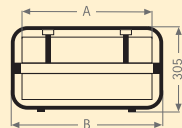

Tisch, waagrecht / table, horizontal

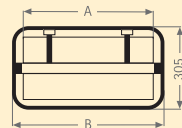

Wand, waagrecht / wall, horizontal

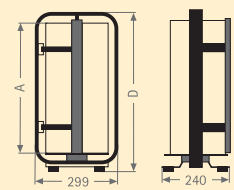

Tisch, senkrecht / table, vertical

DE	BACKTRENNFOLIE AUS PTFE-GLASGEWEBE
EN	BAKING FOIL MADE OF PTFE-COATED GLASS FABRIC
IT	CARTA DA FORNO IN TESSUTO IN FIBRA DI VETRO RIVESTITO IN PTFE
ES	LAMINA DE TEFLÓN (PTFE) ANTIADERENTE PARA HORNO

Antihaftend (PTFE-beschichtetes Glasfasergewebe)

- Hervorragende Trenneigenschaften
- Reißfest
- Temperaturbeständig von -70 °C bis +260 °C
- Beidseitig verwendbar
- Geschmacksneutral
- Spülmaschinenfest
- Bis zu 1.000 x verwendbar (bei sachgerechter Anwendung)

Non-stick quality (PTFE coated glass fabric)

- Tear-resistant
- Usuable from -70 °C to +260 °C
- Usable on both sides
- Neutral in taste
- Dishwasher-proof
- Reusable up to 1.000 times (if used properly)

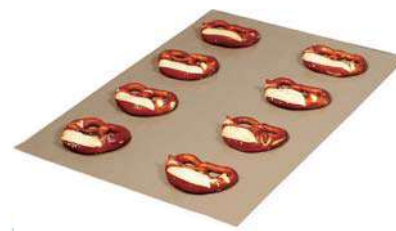

Farbe: braun

Color: brown

#	↔ mm	⏊ mm	⚖ g/m <sup>2</sup>	🛒
110110	330 x 400	0,073	120	20
110108	400 x 500	0,073	120	20
110500	400 x 600	0,073	120	20
110520	500 x 700	0,073	120	20
110540	570 x 780	0,073	120	20
110550	570 x 980	0,073	120	20
110562	600 x 800	0,073	120	20
110116	325 x 530	0,11	220	20
110100	400 x 600	0,11	220	20
110140	570 x 780	0,11	220	20
110150	570 x 980	0,11	220	20
110700	400 x 600	0,215	445	20
110720	570 x 780	0,215	445	20
110740	570 x 980	0,215	445	20



GN  
1/1

📌 Sonderformate auf Anfrage. / Special sizes upon request.

Auf Rolle

On a roll

#	→ mm	↑ Meter	⏊ mm
110940	400	50	0,11
110957	570	50	0,11



DE	ABROLLGERÄT
EN	DISPENSER
IT	DISTRIBUTORE
ES	DISPENSADOR

Material: PVC

Made of PVC

#	↔ mm
391980	890 x 140 x 100



DE	BACK- UND TIEFKÜHLMATTEN
EN	BAKING AND FREEZER MATS
IT	TAPPETI DA FORNO E DA CONGELATORE IN SILICONE
ES	ESTERAS PARA HORNEAR Y CONGELAR

Material: silikonbeschichtetes Glasfasergewebe

- Sehr robust
- Temperaturbeständig von -40 °C bis +230 °C
- Vorzügliche Antihafffähigkeit
- Vorteilhaft in Verbindung mit Lochblechen

Made of siliconized glass fibre fabric

- Very strong quality
- Usable from -40 °C to +230 °C
- Excellent non-stick quality
- Recommended to be used in combination with perforated baking trays

**Especially for lyed baking products including "pretzels"**

**Speziell für Laugenprodukte**

#	↔ mm	für / for mm
107785	315 x 520	325 x 530 (GN 1/1)
107782	385 x 585	400 x 600
107783	570 x 770	580 x 780

**i** Sonderformate auf Anfrage. / Special sizes upon request.

**Silikonmatte Macarons**

• Einteilung Ø: 35 mm

**Silicon mat for macarons**

• Division Ø: 35 mm

#	↔ mm
107784	300 x 400

**Material: 100% Silikon**

**Made of 100% silicone**

#	↔ mm
107790	310 x 510
107791	400 x 600

**Silikonmatte Macarons**

• Einteilung Ø: 40 mm

**Silicon mat for macarons**

• Division Ø: 40 mm

#	↔ mm	↑ mm
115165	400 x 600	1,5

DE	BACKTRENNSPRAY
EN	RELEASE SPRAY
IT	SPRAY STACCANTE ANTIADERENTE
ES	DESMOLDEANTE EN SPRAY

Das perfekte Trennspray für Bäckereien, Konditoreien, Küchen und Gastronomie. Speziell für WALTER-Backformen geeignet. Kein Anbacken oder Ankleben der Backwaren; keine Rückstände in der Form oder auf dem Blech. Reines Lebensmittel, 100 % geschmacksneutral. Zutaten: Pflanzliche Öle  
Verdickungsmittel: Carnaubawachs  
Emulgator: Sonnenblumenlecithine  
Treibgas: Butan / Isobutan / Propan  
**Nur zur gewerblichen Verarbeitung. Nicht für Luftfracht zugelassen.**

The ideal release spray for bakeries, confectioneries, hotel and restaurant kitchens. Especially suitable for WALTER baking moulds. No caking or sticking of the baked goods; no residues in the mould or on the tray. 100 % safe for consumption and tasteless.  
Ingredients: vegetable oils  
Thickener: carnauba wax  
Emulsifier: sunflower lecithin  
Propellant: butane / isobutane / propane  
**Only for professional use. Not permitted for transport via airfreight.**

#	↕ ml
266960	500



DE	MUFFINFORMEN-VERBUND „TULPE“
EN	MUFFIN TRAYS “TULIP”
IT	PORTA PIROTTINI MUFFIN "TULIPANO"
ES	PLACA DE ALUMINIO PARA MUFFINS “TULIPA”

Material: Aluminium

- Für 24 Muffinformen „TULPE“
- Ø: 70 mm
- Gewicht: 1400 g

Made of aluminium

- For 24 Muffin baking cups “TULIP”
- Ø: 70 mm
- Weight: 1400 g

#	↔ mm
381150	600 x 400 x 40



Material: Aluminium

- Für 24 Muffinformen „TULPE“
- Ø: 70 mm

Made of aluminium

- For 24 Muffin baking cups “TULIP”
- Ø: 70 mm

#	↔ mm
381151	580 x 390 x 38



DE	MUFFINFORMEN-VERBUND „TULPE“
EN	MUFFIN TRAYS “TULIP”
IT	PORTA PIROTTINI MUFFIN "TULIPANO"
ES	PLACA DE CARTON PARA MUFFINS “TULIPA”

Material: backfester Wellpappkarton

- Für 24 Muffinformen

Made of bakeable cardboard

- For 24 Muffin cups

#	↔ mm	
122260	580 x 390 x 35	42

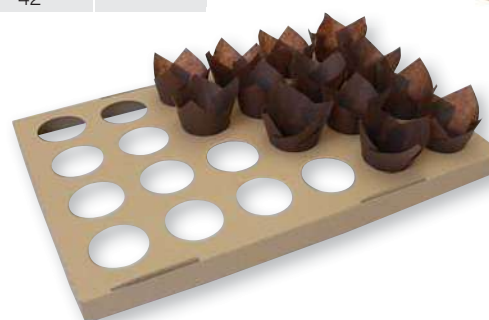

DE	MUFFINFORM TULPE
EN	MUFFIN CUPS TULIP
IT	PIROTTINI PER MUFFIN TULIPANO
ES	CÁPSULAS PARA MUFFINS TULIPA

Material: Reines Zellulose Papier

- Hitze- und fettbeständig
- Hitzebeständigkeit: 180 – 200 °C (1h)

Made of pure cellulose paper

- Heat and grease resistant
- Heat resistance: 180 – 200 °C (1h)



#		↓ Ø mm	↑ mm	
122250	● braun / brown	50	95	1000
122270	● braun / brown	50	55	1000
122271	● rot / red	50	55	1000
122272	● gelb / yellow	50	55	1000
122273	● blau / blue	50	55	1000
122274	● violett / lila	50	55	1000
122275	● grün / green	50	55	1000
122276	● orange / orange	50	55	1000
122277	● pink / pink	50	55	1000



DE	GEBÄCKKAPSELN
EN	BAKING CASES
IT	PIROTTINI MARRONI
ES	CÁPSULAS MARRONES

Aus Pergamyn, schokobraun

- Backfest

Made of glassine, chocolate brown

- Bakeable



#	↓ Ø mm	↑ mm	
125025	25	18	1000
125028	28	16	1000
156009	50	27	1000
156008	70	30	1000

Aus Pergamentersatz, weiß

- Backfest

Made of greaseproof paper, white

- Bakeable



#	↓ Ø mm	↑ mm	
122018	20	18	1000
122024	25	18	1000
122035	35	20	1000
122040	40	21	1000
122045	45	25	1000
122050	50	25	1000
122055	55	25	1000
122060	60	25	1000
122065	65	22	1000
122070	70	20	1000
122075	75	21	1000
122080	80	25	1000





# 122100



# 122110

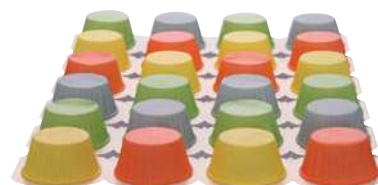

# 122105



DE	MUFFINFORMEN-VERBUND
EN	MUFFIN TRAYS
IT	PORTA PIROTTINI PER MUFFIN
ES	CAPSULAS PARA MUFFINS EN PLACAS



- Perforiert – leichte Entnahme
- Höhe: 35 mm
- Perforated – easy to remove
- Height: 35 mm

#	↑ Ø mm	↓ Ø mm	↔ mm	⬇ g	🛒
122100	68	50	338 x 504	2 OZ ca. / 50	125 trays
122105	68	50	338 x 504	2 OZ ca. / 50	100 trays
122110	80	63	385 x 575	4 OZ ca. / 100	125 trays

DE	BACKFORM "KÖNIGSKUCHEN"
EN	LOAF CAKE BAKING MOULD
IT	STAMPO "PLUMCAKE"
ES	MOLDE "PLUMCAKE"

- Material: backfestes zweilagiges Papier
- 150 g/m<sup>2</sup>
  - Temperaturbeständig von -40°C bis +220°C
- Made of bakeable paper, two layers
- 150 g/m<sup>2</sup>
  - Temperature resistant from -40°C to +220°C

#	↗ mm	→ mm	↑ mm	⬇ g	🛒
122400	150	65	50	200	1080
122410	200	65	45	300	600
122420	225	70	65	400	516
122430	260	50	50	500	300



DE	BACKFORMEN RUND
EN	BAKING MOULDS ROUND
IT	STAMPI TONDI PER TORTE
ES	MOLDES PARA TARTA

- Material: backfestes zweilagiges Papier
- 125 g/m<sup>2</sup>
  - Temperaturbeständig von -40°C bis +220°C
- Made of bakeable paper, two layers
- 125 g/m<sup>2</sup>
  - Temperature resistant from -40°C to +220°C

#	Ø mm	↑ mm	🛒
122700	100	30	450
122720	155	35	540
122740	185	30	600
122780	220	40	500



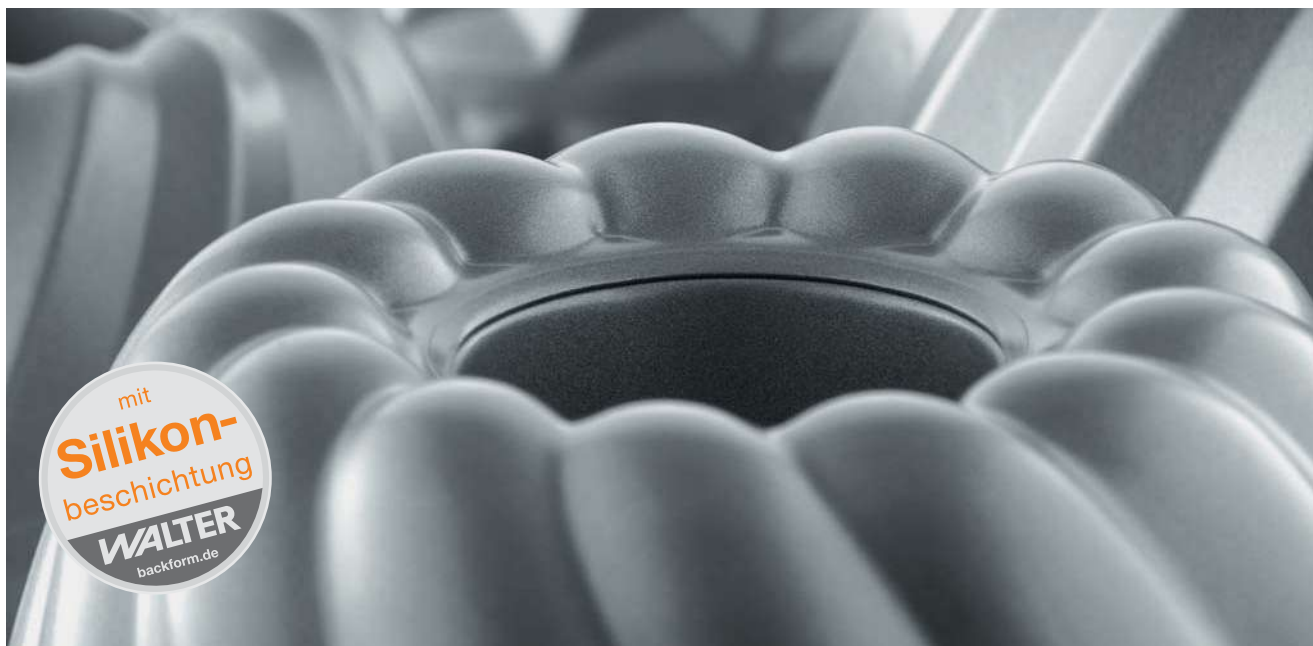

#### PREMIUM-QUALITÄT ANTIHAFT

- Spezielle Antihaf-Beschichtung
- Erhöhung der Verschleißfestigkeit durch Einsatz keramischer Partikel
- Besonders schwere Profi-Qualität
- Optimale Wärmeleitung
- Gleichmäßiges Backen
- Obstsäurebeständig

Bitte beachten:

- Alle Backformen bitte grundsätzlich einfetten (kein Öl verwenden)!
- Form nicht mit spitzen und scharfen Gegenständen behandeln
- Kuchen 5 –10 Min. auskühlen lassen, dann gleich aus der Form lösen
- Schnelle und einfache Reinigung: mit einem Tuch und heißem Wasser unter Zusatz eines handelsüblichen Spülmittels auswaschen
- Zur Schonung der Beschichtung keine Reinigung in der Spülmaschine
- Form nicht im Froster verwenden
- Nicht für Holzbacköfen geeignet
- Einsetzbar bis ca. +200 °C
- Zur Schonung der Beschichtung – Formen bitte nicht ohne Schutz stapeln

#### PREMIUM-QUALITY NON-STICK

- Outstanding anti-stick properties
- Wear-resistant by special coating using ceramic particles
- Particularly heavy professional quality
- Excellent thermal conductivity
- Intensive and all around browning
- Acid resistant

Please notice:

- All baking moulds must be buttered (please do not use oil)!
- Never use pointed or sharp utensils
- Let cake cool down for 5 –10 minutes, then loosen cake out of the mould right away
- Easy cleaning: with a damp cloth, mild detergent and hot water
- Not dish-washer proof
- Not useable in the freezer
- Not useable in wood-fired ovens
- Useable up to +200 °C
- To protect the coating – please do not stack baking moulds without protection

DE	RODONFORM – MIT GLATTEM RAND
EN	RODON MOULD – WITH PLAIN RIM
IT	STAMPO AMERICANO – CON BORDO LISCIO
ES	MOLDE RODON – CON BORDE LISO



#	Ø mm	↑ mm	⚖ l
901314	140	72	0,6
901316	160	85	1,0
901318	180	95	1,4
901320	200	105	1,8
901322	220	115	2,2
901324	240	125	2,9
901326	260	135	3,8



3

DE	GUGELHUPF-FORM
EN	GUGELHUPF MOULD
IT	STAMPO PER GUGELHUPF
ES	MOLDE PARA GUGELHUPF



#	Ø mm	↑ mm	⚖ l
930020	200	104	1,8



DE	SANDKRAZFORM – MIT GLATTEM BODEN
EN	SAVARIN RING MOULD – WITH PLAIN BOTTOM
IT	STAMPO SAVARIN – FONDO LISCIO
ES	MOLDE PARA SAVARIN – FONDO LISO



#	Ø mm	↑ mm	⚖ l
926820	200	65	1,45
926822	220	70	1,80
926824	240	77	2,25
926826	260	82	3,00
926828	280	89	3,70



DE	FRANKFURTER KRAZFORM - MIT GERIPPTEM BODEN
EN	SAVARIN RING MOULD – WITH WAVY BOTTOM
IT	STAMPO TROIS FRERES – FONDO FESTONATO
ES	MOLDE PARA SAVARIN – FONDO RIZADO



#	Ø mm	↑ mm	⚖ l
915120	200	65	1,35
915122	220	70	1,85
915124	240	77	2,35
915126	260	82	2,95
915128	280	89	3,60





**WALTER**  
...einfach besser backen...

DE	KÄSETORTENFORM – MIT GERADEM RAND	
EN	CHEESE FLAN PAN – WITH STRAIGHT RIM	
IT	TORTIERA TONDA – CON BORDO LISCIO	
ES	MOLDE REDONDO – CON BORDE DERECHO	

#	Ø mm	↑ mm	↓ mm	l
967028	280	40		2,30



**WALTER**  
...einfach besser backen...

DE	SPRINGFORM	
EN	SPRINGFORM CAKE TIN	
IT	STAMPO APRIBILE	
ES	MOLDE DESMONTABLE PARA TARTA	

- Verschluss aus rostfreiem Edelstahl
- Quick release clasp made of stainless steel

#	Ø mm	↑ mm	↓ mm	l
900020	200	70		2,15
900024	240	70		3,00
900026	260	70		3,50
900028	280	70		4,05



DE	TEIGSCHABER / KUCHENLÖSER
EN	DOUGH SCRAPER
IT	SPATOLA
ES	ESPÁTULA

- Material: PP, weiß
- Ideal fürs Kuchenlösen in beschichteten Backformen
  - Made of PP, white
  - Ideal for loosening cakes in coated baking moulds

#	↗ mm	→ mm	↑ mm
227099	220	35	6



**WALTER**  
...einfach besser backen...

DE	SPRINGBLECH – KONISCH	
EN	SPRINGFORM CAKE TIN – CONICAL	
IT	STAMPO APRIBILE – CONICO	
ES	MOLDE CONICO DESMONTABLE PARA TARTA	

- Verschluss aus rostfreiem Edelstahl
- Quick release clasp made of stainless steel

#	↑ Ø mm	↓ Ø mm	↑ mm	↓ mm	l
902028	280	260	60		3,30
902032	320	300	60		4,35

 Zur Schonung der Beschichtung – Formen bitte nicht ohne Schutz stapeln.  
To protect the coating – please do not stack baking moulds without protection.



DE	KUCHENBLECH
EN	CAKE MOULD
IT	TORTIERA TONDA
ES	MOLDE REDONDO



#	↑ Ø mm	↓ Ø mm	↑ mm	📏 l
904024	240	200	35	1,30
904026	260	220	35	1,50
904028	280	240	35	1,80
904030	300	260	35	2,10
904032	320	280	35	2,40
904034	340	300	35	2,75
904036	360	320	35	3,05



3

DE	PIZZABLECH
EN	PIZZA MOULD
IT	STAMPO PER PIZZA
ES	MOLDE PARA PIZZA



#	↑ Ø mm	↓ Ø mm	↑ mm	📏 l
904524	240	210	25	0,90
904526	260	235	25	1,10
904528	280	250	25	1,25



Nicht für Holzbacköfen geeignet! / Not suitable for wood-fired ovens!

DE	OBSTTORTENFORM – MIT GERIPPTEM RAND UND GEPRÄGTEM BODEN
EN	FRUIT FLAN PAN - WITH FLUTED RIM AND STAMPED BOTTOM
IT	STAMPO PER CROSTATE DI FRUTTA CON BORDO FESTONATO E FONDO GOFFRATO
ES	MOLDE PARA TARTA DE FRUTAS CON BORDE RIZADO Y FONDO GOFRADO



#	↑ Ø mm	↓ Ø mm	↑ mm	📏 l
949928	280	253	32	1,50
949930	300	273	32	1,70
949932	320	293	32	1,80



DE	KÖNIGSKUCHENFORM
EN	LOAF CAKE MOULD
IT	STAMPO PER PLUMCAKE
ES	MOLDE PLUMCAKE



#	→ mm	↗ mm	↑ mm	📏 l
910020	90	200	70	1,05
910025	100	250	70	1,45
910030	110	300	79	2,15
910035	120	350	85	3,00





**WALTER**  
...einfach besser backen...

DE	HERZFORM
EN	HEART MOULD
IT	STAMPO CUORE
ES	MOLDE CORAZÓN



#	→ mm	↑ mm	∩ l
940025	250	61	2,60
940027	270	65	3,30



**WALTER**  
...einfach besser backen...

DE	WOLFSZAHNBLECH
EN	DENTS DE LOUP BISCUITS BAKING SHEET
IT	TEGLIA PER BISCOTTI "DENTI DI LUPO"
ES	PLACA PARA "DIENTES DE LOBO"



#	↗ mm	→ mm
920000	350	330



**WALTER**  
...einfach besser backen...

DE	REHRÜCKENFORM
EN	RIDGED BAKING MOULD
IT	STAMPO AMOR POLENTA
ES	MOLDE MEDIA CAÑA REDONDO ONDULADO



#	→ mm	↗ mm	↑ mm	∩ l
994628	110	280	60	1,35
994633	110	330	60	1,60



DE	QUICHE-FORM
EN	"QUICHE" MOULD
IT	STAMPO QUICHE
ES	MOLDE QUICHE



- Mit praktischem Auslöseboden
- With removable bottom

#	↑ Ø mm	↑ mm	⚙ I	
901050	300	30	1,80	



3

DE	WEIHNACHTSSTERN-FORM
EN	CHRISTMAS STAR MOULD
IT	STAMPO "STELLA DI NATALE"
ES	MOLDE "ESTRELLA DE NAVIDAD"



#	→ mm	↓ mm	↑ mm	⚙ I	
967040	150	340	65	2,25	



DE	BRIOCHEFORM
EN	BRIOCHE MOULD
IT	STAMPI A BRIOCHE
ES	MOLDES BRIOCHE



#	Ø mm	↑ mm	⚙ I	
951012	120	45	0,25	
951014	140	50	0,43	
951016	160	60	0,63	



DE	HERZFORM MIT GERIPPTEM RAND
EN	FLUTED HEART MOULD
IT	STAMPO CUORE FESTONATO
ES	MOLDE CORAZON RIZADO





#	↔ mm	↑ mm	⚙ I	
967075	270	30	1,3	





**WALTER**  
...einfach besser backen...

DE	12-MUFFINFORM	
EN	12-CUP MUFFIN PAN	
IT	STAMPO PER 12 MUFFIN	
ES	MOLDE PARA 12 MUFFINS	

#	Formen	 ml	$\leftrightarrow$ mm	$\varnothing$ mm
960020	12	90	370 x 242 x 30	62



**WALTER**  
...einfach besser backen...

DE	MADELEINE	
EN	MADELEINE	
IT	MADELEINE	
ES	MADELEINE	

Material: Stahl

Made of carbon steel

#	Formen / cavities (mm)	$\leftrightarrow$ mm
967065	12 (55 x 44)	350 x 145 x 15
967070	12 (77 x 52)	405 x 195 x 19



**WALTER**  
...einfach besser backen...

DE	FUSSBALLFORM	
EN	FOOTBALL MOULD	
IT	STAMPO PALLONE DA CALCIO	
ES	MOLDE BALÓN DE FÚTBOL	

#	$\varnothing$ mm	 l
967050	225 mm	2,75



**WALTER**  
...einfach besser backen...

DE	FUSSBALLFELD	
EN	FOOTBALL FIELD	
IT	STAMPO DA CAMPO DI CALCIO	
ES	MOLDE CAMPO DE FÚTBOL	

#	$\leftrightarrow$ mm	 l
967060	350 x 245	3,6





DE	LAMM-FORM
EN	LAMB MOULD
IT	STAMPO "AGNELLO"
ES	MOLDE "EL BORREGO"



Material: vorbehandelter Stahl  
 • Mit Antihafbeschichtung  
 • Inkl. 2 Klammern

Made of precoated steel  
 • With non-stick coating  
 • Incl. 2 clips

**KLEIN / Kopf seitwärts**

**SMALL / Head turned to the left**

#	→ mm	↓ mm	↑ mm	⊕ l
968000	163	67	108	0,5



3

**GROSS / Kopf gerade**

**LARGE / Head pointing straight ahead**

#	→ mm	↓ mm	↑ mm	⊕ l
968010	245	80	160	1,0



DE	STÄNDER ZUM BEFÜLLEN DER LAMMFORMEN
EN	STAND FOR FILLING LAMB CAKE MOULDS
IT	SUPPORTO PER IL RIPIPIAMENTO DEGLI STAMPI "AGNELLO"
ES	SOPORTE MOLDES "EL BORREGO"

Material: aluminierter Stahl

Made of aluminized steel

#	→ mm	↗ mm	für / for #
für kleines Lamm / for small lamb			
968020	167	376	968000
für großes Lamm / for large lamb			
968030	250	500	968010



DE	LAMMFORM-SET
EN	SET OF LAMB MOULDS
IT	SET DI STAMPO "AGNELLO"
ES	JUEGO DE MOLDES "EL BORREGO"



• Komplet mit 5 Lämmern,  
 1 Ständer und 10 Klammern

• Consisting of 5 large lambs,  
 1 stand and 10 clips

#		⊕ l
968040	klein / small	0,5
968050	gross / large	1,0





**PREMIUM-QUALITÄT EMAILLIERT**

- Quarz-Email-Beschichtung
- Schnitt- und kratzfest
- Obstsäurebeständig

Alle Backformen bitte grundsätzlich einfetten (kein Öl verwenden)!

Bitte beachten:

- Form leicht einfetten
- Kuchen 5 – 10 Min. auskühlen lassen, dann gleich aus der Form lösen
- Schnelle und einfache Reinigung: mit einem Tuch und heißem Wasser unter Zusatz eines handelsüblichen Spülmittels auswaschen
- Form nicht im Froster verwenden

**PREMIUM-QUALITY ENAMEL**

- Quarz-enamel coated surface
- Cut- and scratch resistant
- Acid resistant

All baking moulds must be buttered (please do not use oil)!

Please notice:

- Butter mould slightly
- Let cake cool down for 5 – 10 minutes, then loosen cake out of the mould right away
- Clean immediately with warm water and dry thoroughly
- Do not use moulds in the freezer



DE	KUCHENBLECH	
GB	CAKE MOULD	
IT	TORTIERE TONDE, SMALTATE	
ES	MOLDE REDONDO, ESMALTADO	

Emailliert, schnittfest, Farbe schwarz  
max. +300°C

Enamel, cut proof, color black  
max. +300°C

#	↑ Ø mm	↑ mm	↓ I	
981040	300	35	2,05	
981041	320	35	2,35	



DE	KASTENFORM/BROTBACKFORM	
GB	BREAD MOULD	
IT	STAMPI DA PANE	
ES	MOLDE PARA PAN	

Emailliert, schnittfest, Farbe schwarz,  
max. +300°C

Enamel, cut proof, color black,  
max. +300°C

#	→ mm	↗ mm	↑ mm	↓ I	
912030	110	300	79	2,15	
912035	120	350	85	3,00	





© mahony - stock.adobe.com

DE	STOLLENFORMENVERBAND	
EN	CHRISTSTOLLEN MOULD	ALU STEEL
IT	TEGLIA PER STOLLEN	
ES	MOLDE PARA STOLLEN	



- Ausführung: 4-teilig
- Inklusive Deckel
- Stahlblech aluminisiert
- Rückseite geschwärzt
- Geeignet für Stikkenofen
- Type: 4 pieces
- Including lid
- Sheet steel aluminized
- Back side blackened
- Suitable for baking trolley

#	↑ mm	←→ mm	g
154900	160 x 108 x 60	580 x 185	ca. 400
154901	230 x 100 x 70	580 x 255	ca. 500
154903	300 x 120 x 75	580 x 325	ca. 1000



DE	SCHIFFCHEN
EN	BOAT MOULDS
IT	STAMPI A BARCHETTA
ES	MOLDE BARQUITA

**GLATT**

- Ovale Form
- Mit Antihaft-Beschichtung (PTFE)

**PLAIN**

- Oval shape
- With non-stick coating (PTFE)



#	↗ mm	→ mm	↑ mm	
995031	80	33	12	
995032	90	40	12	
995033	100	43	13	
995034	110	46	13	
995035	120	50	13	

**GEWELLT**

- Ovale Form
- Mit Antihaft-Beschichtung (PTFE)

**WAVY**

- Oval shape
- With non-stick coating (PTFE)



#	↗ mm	→ mm	↑ mm	
995040	80	40	12	
995042	90	43	12	
995043	100	45	12	
995044	110	47	13	
995045	120	50	14	

DE	BRIOCHE FORMEN
EN	BRIOCHE MOULDS
IT	STAMPI A BRIOCHE
ES	MOLDES BRIOCHE

- Flacher Boden
- Mit Antihaft-Beschichtung (PTFE)

- Flat bottom
- With non-stick coating (PTFE)



#	↑ Ø mm	↓ Ø mm	↑ mm	
995062	75	40	30	
995063	80	40	32	
995064	90	45	35	
995065	100	55	38	
995066	110	55	42	

DE	SAVARIN FORMEN
EN	SAVARIN MOULDS
IT	STAMPI SAVARIN
ES	MOLDES PARA SAVARIN

- Dom geschlossen
- Mit gebördeltem Rand
- Mit Antihaft-Beschichtung (PTFE)
- Dome closed
- With rolled edge
- With non-stick coating (PTFE)

#	↑ Ø mm	↑ mm
995072	80	20



3

DE	PETITS FOUR FÖRMCHEN
EN	PETITS FOUR MOULDS
IT	STAMPI PER TARTELETTE
ES	MOLDES PARA TARTELETAS

- Dose mit 60 Pralinenförmchen
- 12 verschiedene Modelle à 5 Stück
- Mit Antihaft-Beschichtung (PTFE)
- Box of 60 petits fours moulds
- 12 different models, 5 pcs. each
- With non-stick coating (PTFE)

#	Inhalt / Content
995020	60 Stück / pieces



- Mit Antihaft-Beschichtung (PTFE)
- With non-stick coating (PTFE)

#		↔ mm
995121	gerippter Dom / ribbed dome	Ø 45
995122	rund, gewellt / round, wavy	Ø 45
995123	oval, gerippt / oval, ribbed	Ø 45
995124	Quadrat, gewellt / square, wavy	Ø 35
995125	oval, gewellt / oval, wavy	Ø 45
995126	Raute, glatt / diamond, plain	60
995127	Boot glatt / boat plain	60
995129	Rechteck, glatt / rectangle, plain	Ø 50
995130	rund, glatt / round, plain	Ø 35
995131	rund, glatt / round, plain	Ø 40
995132	rund, glatt, tief / round, plain, deep	Ø 35



DE	TORTELETT FORMEN
EN	TARTLET MOULDS
IT	STAMPI PER TARTELETE
ES	MOLDES TARTELETAS

- Rund gewellt
- Mit Antihft-Beschichtung (PTFE)
- Round, wavy
- With non-stick coating (PTFE)



#	↑ Ø mm	↓ Ø mm	↑ mm
995080	60	50	10
995081	70	60	10
995082	80	70	12
995083	90	75	15
995084	100	85	18
995085	110	90	20
995086	120	110	20
995087	140	130_	25



- **Mit herausnehmbarem Bodenteil**
- Rund gewellt
- Mit Antihft-Beschichtung (PTFE)
- **With removable bottom**
- Round, wavy
- With non-stick coating (PTFE)

#	↑ Ø mm	↓ Ø mm	↑ mm
995090	100	85	18
995091	110	90	20
995092	120	110	20
995093	140	130_	25

DE	KUCHEN / QUICHE / FORMEN
EN	TART/QUICHE MOULDS
IT	STAMPI QUICHE
ES	MOLDES QUICHE

- **Mit herausnehmbarem Bodenteil**
- Rund gewellt
- Mit Antihft-Beschichtung (PTFE)
- **With removable bottom**
- Round, wavy
- With non-stick coating (PTFE)



#	↑ Ø mm	↓ Ø mm	↑ mm
995100	200	185	35
995101	220	200	35
995102	240	225	35
995103	260	240	35
995104	280	265	35
995105	300	280	35
995106	320	305	35



- Material: Aluminium
- Materialstärke: 1 mm
- Made of aluminium
- Thickness: 1 mm

#	↑ Ø mm	↓ Ø mm	↑ mm
997976	280	260	25
997977	320	300	25

DE	KUCHENBLECH
EN	CAKE MOULD
IT	TORTIERA TONDA
ES	MOLDE REDONDO

- Material: Aluminium
- Materialstärke: 1 mm
  - Konisch

- Made of aluminium
- Thickness: 1 mm
  - Conical

#	↑ Ø mm	↓ Ø mm	↑ mm
997910	300	260	40
997911	320	280	40
997912	340	300	40
997913	360	320	40
997914	380	340	40

997920	320	300	50
997921	340	320	50



3

DE	SANDKLANZFORM – MIT GLATTEM BODEN
EN	SAVARIN RING MOULD – WITH PLAIN BOTTOM
IT	STAMPO SAVARIN – FONDO LISCIO
ES	MOLDE PARA SAVARIN – FONDO LISO

- Material: Aluminium
- Dom offen
  - Mit gebördeltem Rand

- Made of aluminium
- Open tube
  - With rolled edge

#	Ø mm	↑ mm
997986	220	70
997987	240	80
997988	260	85



DE	KÖNIGSKUCHENFORM
EN	LOAF CAKE MOULD
IT	STAMPO PER PLUMCAKE
ES	MOLDE PLUMCAKE

- Material: Aluminium
- Materialstärke: 1 mm

- Made of aluminium
- Thickness: 1 mm

#	↗ mm	→ mm	↑ mm
997941	180	78	58
997942	220	90	65
997943	260	100	73
997944	300	105	73





**BACKFORMEN AUS SILIKON 300 x 175 mm**

Material: hochwertiges und lebensmittelechtes Silikon, mit Antihafteffekt – kein vorheriges Einfetten mehr notwendig!  
 Temperaturbereich: – 60 bis +230 °C  
 (für Backöfen, Mikrowelle oder Gefrierschränke)  
 Größe der Backformen: 175 x 300 mm (GN1/3)

Bei richtiger Anwendung sind folgende Punkte zu beachten:

- Backgut immer abkühlen lassen
- Backformen niemals in direkten Kontakt mit Herdplatten, Feuer oder Grill bringen (am besten die Backformen auf Gitter oder Backbleche auflegen)
- Niemals das Backgut mit scharfen Gegenständen heraustrennen
- Niemals aggressive Reinigungsmittel verwenden, sondern von Hand reinigen

**BAKING MOULDS MADE OF SILICONE 300 X 175 mm**

Made of high quality, food safe and non-sticking silicone – without prior greasing!  
 Temperature range: from – 60 to +230 °C  
 (for ovens, microwaves and freezers)  
 Size of the baking moulds: 175 x 300 mm (GN 1/3)

For optimal using please note the following points:

- Let cool down the products before extraction.
- Never use baking moulds on heat sources (fire, grill, electric plates)
- Never use sharp objects to remove your products from the moulds
- Never use aggressive detergents to clean moulds after use, just clean by hand

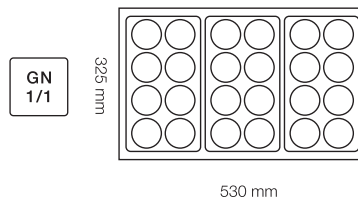
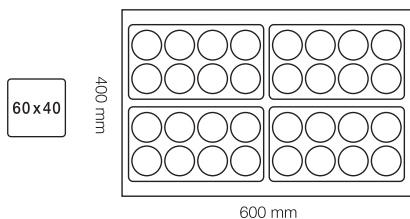



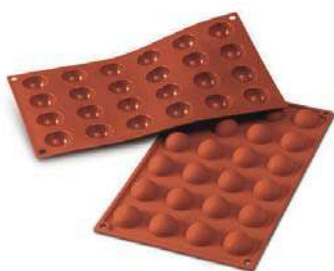

DE	HALBKUGELN MINI
EN	HALF-SPHERES MINI
IT	SEMISFERE MINI
ES	SEMIESFERAS MINI

<input checked="" type="checkbox"/> #	115220
Formen/cups	24 x 10 ml
Ø mm	30
↑ mm	15



DE	HALBKUGELN
EN	HALF-SPHERES
IT	SEMISFERE
ES	SEMIESFERAS

<input checked="" type="checkbox"/> #	115003
Formen/cups	5 x 120 ml
Ø mm	80
↑ mm	40

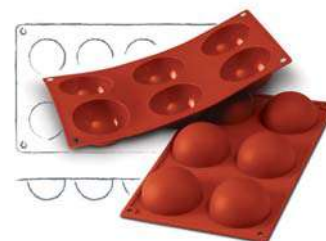

<input checked="" type="checkbox"/> #	115005
Formen/cups	6 x 80 ml
Ø mm	70
↑ mm	35



DE	FLORENTINER MINI
EN	FLORENTINES MINI
IT	FIorentINE MINI
ES	FLORENTINAS MINI

<input checked="" type="checkbox"/> #	115226
Formen/cups	24 x 5 ml
Ø mm	35
↑ mm	5



DE	FLORENTINER
EN	FLORENTINES
IT	FIorentINE
ES	FLORENTINAS

<input checked="" type="checkbox"/> #	115006
Formen/cups	8 x 35 ml
Ø mm	60
↑ mm	12



DE	SAVARIN
EN	SAVARIN
IT	SAVARIN
ES	SAVARIN

<input checked="" type="checkbox"/> #	115007
Formen/cups	8 x 50 ml
Ø mm	65
↑ mm	21

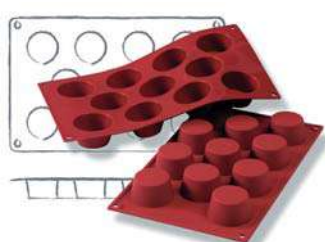

DE	MUFFIN MINI
EN	MUFFIN MINI
IT	MUFFIN MINI
ES	MUFFIN MINI

<input checked="" type="checkbox"/> #	115012
Formen/cups	11 x 50 ml
Ø mm	51
↑ mm	28



DE	MUFFIN MEDIUM
EN	MUFFIN MEDIUM
IT	MUFFIN MEDIUM
ES	MUFFIN MEDIUM

<input checked="" type="checkbox"/> #	115221
Formen/cups	6 x 119 ml
Ø mm	68
↑ mm	38

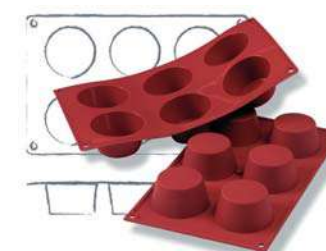

DE	MUFFIN
EN	MUFFIN
IT	MUFFIN
ES	MUFFIN

<input checked="" type="checkbox"/> #	115011
Formen/cups	6 x 100 ml
Ø mm	69
↑ mm	35



DE	MUFFIN GROSS
EN	MUFFIN BIG
IT	MUFFIN GRANDE
ES	MUFFIN GRANDE

<input checked="" type="checkbox"/> #	115131
Formen/cups	6 x 165 ml
Ø mm	75
↑ mm	60

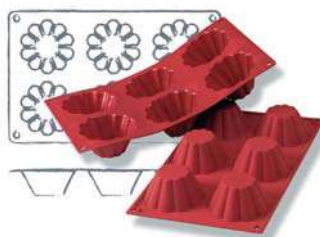

DE	BRIOCHE
EN	BRIOCHE
IT	BRIOCHE
ES	BRIOCHETTES

<input checked="" type="checkbox"/> #	115014
Formen/cups	6 x 110 ml
Ø mm	79
↑ mm	37



DE	TORTELETT
EN	TARTLET
IT	TARTELLETTA
ES	TARTALETA

<input checked="" type="checkbox"/> #	115015
Formen/cups	8 x 40 ml
Ø mm	60
↑ mm	17

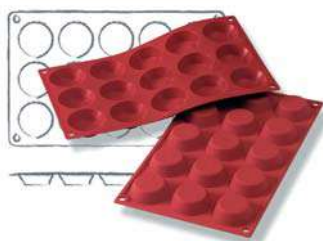

DE	TORTELETT
EN	TARTLET
IT	TARTELLETTA
ES	TARTALETA

<input checked="" type="checkbox"/> #	115016
Formen/cups	15 x 25 ml
Ø mm	50
↑ mm	15



DE	TORTELETT MINI
EN	TARTLET MINI
IT	TARTELLETTA MINI
ES	TARTALETA MINI

<input checked="" type="checkbox"/> #	115017
Formen/cups	15 x 20 ml
Ø mm	45
↑ mm	10



DE	TORTELETT
EN	TARTLET
IT	TARTELLETTA
ES	TARTALETA

<input checked="" type="checkbox"/> #	115022
Formen/cups	6 x 70 ml
Ø mm	70
↑ mm	20

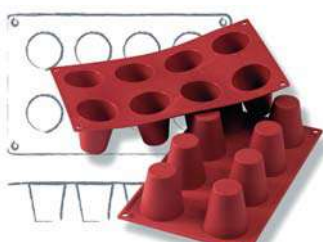

DE	BABA
EN	BABA
IT	BABÀ
ES	BABÁ

<input checked="" type="checkbox"/> #	115024
Formen/cups	8 x 92 ml
Ø mm	55
↑ mm	60

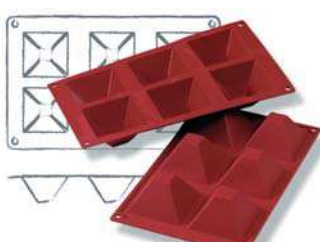

DE	PYRAMIDE
EN	PYRAMID
IT	PIRAMIDE
ES	PIRÁMIDE

<input checked="" type="checkbox"/> #	115028
Formen/cups	6 x 90 ml
↔ mm	71 x 71
↑ mm	40

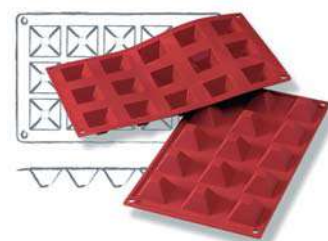

DE	PYRAMIDE
EN	PYRAMID
IT	PIRAMIDE
ES	PIRÁMIDE

<input checked="" type="checkbox"/> #	115029
Formen/cups	15 x 20 ml
↔ mm	36 x 36
↑ mm	22



DE	OVAL
EN	OVAL
IT	OVALE
ES	ÓVALO

<input checked="" type="checkbox"/> #	115030
Formen/cups	9 x 50 ml
↔ mm	70 x 50
↑ mm	20



DE	BISKUIT
EN	SPONGE CAKE
IT	PAN DI SPAGNA
ES	BIZCOCHO

<input checked="" type="checkbox"/> #	115036
Formen/cups	3 x 140 ml
Ø mm	103
↑ mm	20



DE	RECHTECK MINI
EN	FINANCIERS MINI
IT	FINANZIERI MINI
ES	RECTÁNGULO MINI

<input checked="" type="checkbox"/> #	115037
Formen/cups	20 x 20 ml
↔ mm	49 x 26
↑ mm	11



DE	RECHTECK
EN	FINANCIERS
IT	FINANZIERI
ES	RECTÁNGULO

<input checked="" type="checkbox"/> #	115233
Formen/cups	6 x 110 ml
↔ mm	120 x 45
↑ mm	20

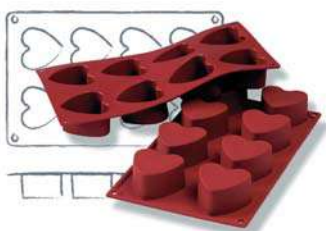

DE	HERZ
EN	HEART
IT	CUORE
ES	CORAZÓN

<input checked="" type="checkbox"/> #	115039
Formen/cups	8 x 90 ml
Ø mm	60
↑ mm	35

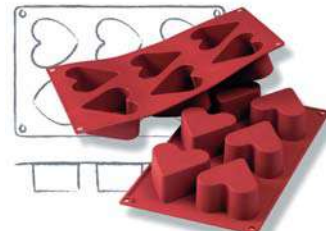

DE	RECHTECK MINI
EN	FINANCIERS MINI
IT	FINANZIERI MINI
ES	RECTÁNGULO MINI

<input checked="" type="checkbox"/> #	115069
Formen/cups	6 x 130 ml
Ø mm	65
↑ mm	40



DE	HERZ "PASSION"
EN	HEART "PASSION"
IT	CUORE "PASSIONE"
ES	CORAZÓN "PASIÓN"

<input checked="" type="checkbox"/> #	115090
Formen/cups	24 x 16 ml
Ø mm	37 x 36
↑ mm	23



<input checked="" type="checkbox"/> #	115091
Formen/cups	10 x 45 ml
Ø mm	56 x 52
↑ mm	29



<input checked="" type="checkbox"/> #	115092
Formen/cups	8 x 72 ml
↔ mm	64 x 62
↑ mm	32



DE	GUGELHUPF MINI
EN	GUGELHUPF MINI
IT	GUGELHUPF MINI
ES	GUGELHUPF MINI

<input checked="" type="checkbox"/> #	115072
Formen/cups	8 x 50 ml
Ø mm	55
↑ mm	36

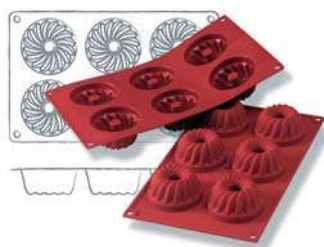

DE	GUGELHUPF MEDIUM
EN	GUGELHUPF MEDIUM
IT	GUGELHUPF MEDIUM
ES	GUGELHUPF MEDIO

<input checked="" type="checkbox"/> #	115071
Formen/cups	6 x 80 ml
Ø mm	70
↑ mm	36



DE	GUGELHUPF
EN	GUGELHUPF
IT	GUGELHUPF
ES	GUGELHUPF

<input checked="" type="checkbox"/> #	115227
Formen/cups	6 x 100 ml
Ø mm	75
↑ mm	40



DE	VULKAN
EN	VULKANO
IT	VULCANO
ES	VOLCÁN

<input checked="" type="checkbox"/> #	115087
Formen/cups	24 x 16 ml
Ø mm	38,7
↑ mm	32,5

<input checked="" type="checkbox"/> #	115088
Formen/cups	15 x 41 ml
Ø mm	52,4
↑ mm	43,7

<input checked="" type="checkbox"/> #	115089
Formen/cups	8 x 72 ml
Ø mm	62,7
↑ mm	52



DE	KUSS
EN	KISS
IT	BACIO
ES	EL BESO

<input checked="" type="checkbox"/> #	115086
Formen/cups	6 x 183 ml
Ø mm	74
↑ mm	66,5



DE	ROSE
EN	ROSE
IT	ROSA
ES	ROSA

<input checked="" type="checkbox"/> #	115093
Formen/cups	15 x 23 ml
↔ mm	44
↑ mm	27



<input checked="" type="checkbox"/> #	115094
Formen/cups	6 x 115 ml
↔ mm	76
↑ mm	40



DE	KUBUS MINI
EN	CUBE MINI
IT	CUBO MINI
ES	CUBO MINI

☑ #	115228
Formen/cups	40 x 13,5 ml
→ mm	24
↑ mm	24

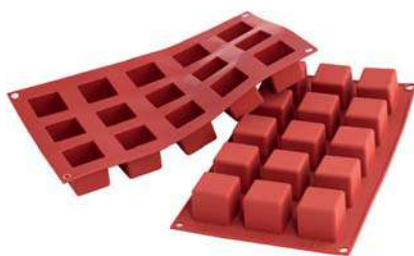

DE	KUBUS
EN	CUBE
IT	CUBO
ES	CUBO

☑ #	115099
Formen/cups	15 x 42 ml
↔ mm	35 x 35
↑ mm	35

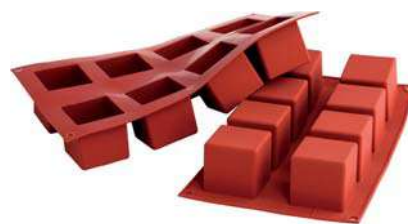

☑ #	115098
Formen/cups	8 x 125 ml
↔ mm	50 x 50
↑ mm	50

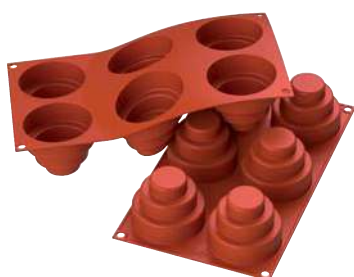

DE	MINI-KUCHEN
EN	MINI-WONDERCAKE
IT	MINITORTA
ES	PASTEL MINI

☑ #	115211
Formen/cups	6 x 177 ml
Ø mm	59 x 29
↑ mm	70

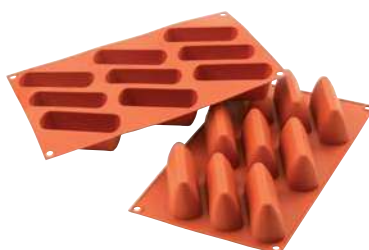

DE	NUSSPRALINE
EN	NUT TRUFFLE
IT	GIANDUIOTTO
ES	BOMBÓN LA NUEZ

☑ #	115212
Formen/cups	9 x 85 ml
↔ mm	93 x 31
↑ mm	42

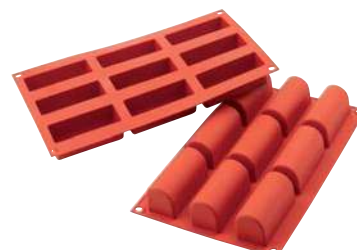

DE	MULDE
EN	HOLLOW
IT	TRONQUETTO
ES	TRONCO MINI

☑ #	115213
Formen/cups	9 x 83 ml
↔ mm	84 x 32
↑ mm	35

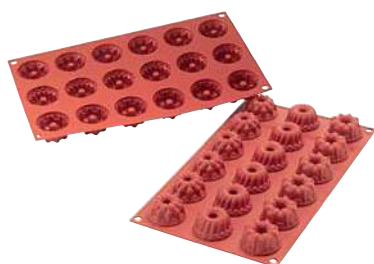

DE	MINI FANTASY
EN	MINI FANTASY
IT	MINI FANTASIA
ES	MINI FANTASY

☑ #	115215
Formen/cups	18 x 17,5 ml
↔ mm	40
↑ mm	22

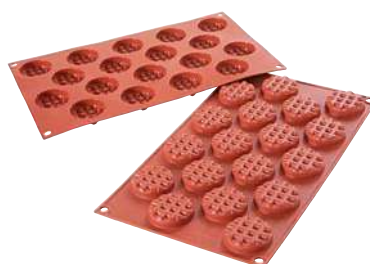

DE	WAFFEL RUND
EN	WAFFLE ROUND
IT	CIALDA TONDA
ES	WAFFLE REDONDO

☑ #	115217
Formen/cups	18 x 11,5 ml
↔ mm	40
↑ mm	12



DE	DESSERT MINI
EN	DESSERT MINI
IT	DESSERT MINI
ES	POSTRE MINI

☑ #	115076
Formen/cups	15 x 12,3 ml
Ø mm	40
↑ mm	13



DE	KUCHEN MINI
EN	CAKE MINI
IT	TORTA MINI
ES	PASTEL MINI

<input checked="" type="checkbox"/> #	115077
Formen/cups	30 x 75 ml
↔ mm	30 x 18
↑ mm	16



DE	ZYLINDER MINI
EN	CYLINDER MINI
IT	CILINDRO MINI
ES	CILINDROS MINI

<input checked="" type="checkbox"/> #	115229
Formen/cups	11 x 55 ml
Ø mm	50
↑ mm	27



DE	ZYLINDER MEDIUM
EN	CYLINDER MEDIUM
IT	CILINDRO MEDIUM
ES	CILINDROS MEDIUM

<input checked="" type="checkbox"/> #	115231
Formen/cups	8 x 123 ml
Ø mm	63
↑ mm	40



DE	ZYLINDER
EN	CYLINDER
IT	CILINDRO
ES	CILINDROS

<input checked="" type="checkbox"/> #	115230
Formen/cups	6 x 103,5 ml
Ø mm	70
↑ mm	27

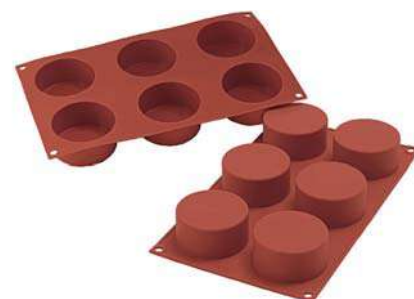

<input checked="" type="checkbox"/> #	115232
Formen/cups	6 x 133 ml
Ø mm	70
↑ mm	35



DE	FLAN MINI
EN	FLAN MINI
IT	FLAN MINI
ES	FLAN MINI

<input checked="" type="checkbox"/> #	115223
Formen/cups	15 x 30 ml
Ø mm	50
↑ mm	14



DE	FLAN MEDIUM
EN	FLAN MEDIUM
IT	FLAN MEDIUM
ES	FLAN MEDIUM

<input checked="" type="checkbox"/> #	115224
Formen/cups	6 x 52 ml
Ø mm	70
↑ mm	17



DE	FLAN
EN	FLAN
IT	FLAN
ES	FLAN

<input checked="" type="checkbox"/> #	115225
Formen/cups	6 x 72 ml
Ø mm	80
↑ mm	18

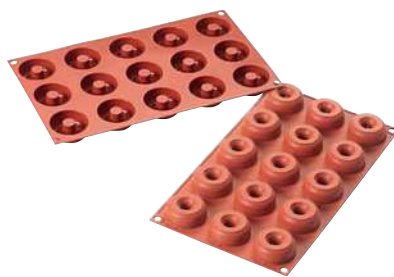
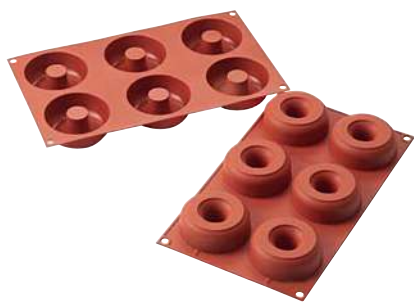

DE	DONUTS
EN	DONUTS
IT	DONUTS
ES	DONUTS

DE	DONUTS MINI
EN	DONUTS MINI
IT	DONUTS MINI
ES	DONUTS MINI

<input checked="" type="checkbox"/> #	115235
Formen/cups	6 x 98 ml
Ø mm	75
↑ mm	25

<input checked="" type="checkbox"/> #	115234
Formen/cups	15 x 22 ml
Ø mm	45
↑ mm	18



DE	ECLAIRS
EN	ECLAIRS
IT	ECLAIRS
ES	ECLAIRS

DE	FANTASY
EN	FANTASY
IT	FANTASIA
ES	FANTASY

<input checked="" type="checkbox"/> #	115253
Formen/cups	10 x 80 ml
↔ mm	125
↑ mm	25

<input checked="" type="checkbox"/> #	115254
Formen/cups	12 x 24 ml
↔ mm	63 x 29
↑ mm	28



**BACKFORMEN AUS SILIKON 600 x 400 mm**

Material: hochwertiges und lebensmittelechtes Silikon, mit Antihafteffekt – kein vorheriges Einfetten mehr notwendig!  
 Temperaturbereich: – 60 bis +230 °C (für Backöfen, Mikrowelle oder Gefrierschränke)  
 Größe der Backformen: 400 x 600 mm

Bei richtiger Anwendung sind folgende Punkte zu beachten:

- Backgut immer abkühlen lassen
- Backformen niemals in direkten Kontakt mit Herdplatten, Feuer oder Grill bringen (am besten die Backformen auf Gitter oder Backbleche auflegen)
- Niemals das Backgut mit scharfen Gegenständen heraustrennen
- Niemals aggressive Reinigungsmittel verwenden, sondern von Hand reinigen

**BAKING MOULDS MADE OF SILICONE 600 x 400 mm**

Made of high quality, food safe and non-sticking silicone – without prior greasing!  
 Temperature range: from – 60 to +230 °C (for ovens, microwaves and freezers)  
 Size of the baking moulds: 400 x 600 mm

For optimal using please note the following points:

- Let cool down the products before extraction
- Never use baking moulds on heat sources (fire, grill, electric plates)
- Never use sharp objects to remove your products from the moulds
- Never use aggressive detergents to clean moulds after use, just clean by hand

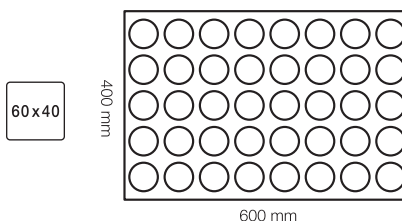





DE	BRIOCHE
EN	BRIOCHE
IT	BRIOCHE
ES	BRIOCHETTE

☑ #	115300
Formen/cups	24 x 84 ml
Ø mm	79
↑ mm	35

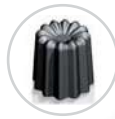

DE	CANELLE
EN	CANELLE
IT	CANELLE
ES	CANELÉ

☑ #	115301
Formen/cups	54 x 80 ml
Ø mm	56
↑ mm	50



DE	HALBKUGELN MINI
EN	HALF-SPHERES MINI
IT	SEMISFERE MINI
ES	SEMIESFERAS MINI

400 x 600 mm

☑ #	115338
Formen/cups	96 x 11 ml
Ø mm	35
↑ mm	17,5



DE	HALBKUGEL
EN	HALF-SPHERE
IT	SEMISFERA
ES	SEMIESFERA

☑ #	115302
Formen/cups	28 x 90 ml
Ø mm	70
↑ mm	35



DE	FLORENTINER MINI
EN	FLORENTINES MINI
IT	FIorentINE MINI
ES	FLORENTINAS MINI

☑ #	115341
Formen/cups	70 x 15 ml
Ø mm	45
↑ mm	10



DE	FLORENTINER
EN	FLORENTINES
IT	FIorentINE
ES	FLORENTINAS

400 x 600 mm

☑ #	115303
Formen/cups	40 x 25 ml
Ø mm	60
↑ mm	11



DE	FLORENTINER
EN	FLORENTINES
IT	FIorentINE
ES	FLORENTINAS

☑ #	115339
Formen/cups	35 x 33,5 ml
Ø mm	60
↑ mm	12



DE	MADELEINE
EN	MADELEINE
IT	MADELEINE
ES	MADELEINE

☑ #	115304
Formen/cups	44 x 32 ml
Ø mm	77 x 44,5
↑ mm	18

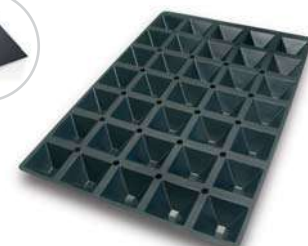

DE	PYRAMIDE
EN	PYRAMID
IT	PIRAMIDE
ES	PIRÁMIDE

400 x 600 mm

☑ #	115305
Formen/cups	35 x 61 ml
Ø mm	65 x 65
↑ mm	35



DE TORTELETT – MINI  
 EN TARTLET – MINI  
 IT TARTELLETTA – MINI  
 ES TARTALETA – MINI

☑ #	115306
Formen/cups	60 x 10 ml
Ø mm	44
↑ mm	10



DE RECHTECK  
 EN FINANCIERS  
 IT FINANZIERI  
 ES RECTÁNGULO

☑ #	115342
Formen/cups	36 x 32 ml
↔ mm	70
↑ mm	26

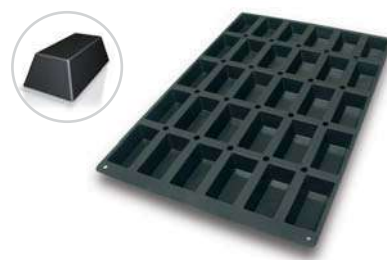

☑ #	115307
Formen/cups	30 x 130 ml
Ø mm	99 x 49
↑ mm	30



DE MUFFIN-MINI  
 EN MUFFIN MINI  
 IT MUFFIN MINI  
 ES MUFFIN MINI

☑ #	115309
Formen/cups	70 x 40 ml
Ø mm	45
↑ mm	30



DE MUFFIN  
 EN MUFFIN  
 IT MUFFIN  
 ES MUFFIN

☑ #	115346
Formen/cups	60 x 25 ml
Ø mm	40
↑ mm	20



☑ #	115308
Formen/cups	24 x 122 ml
Ø mm	69
↑ mm	39



DE GUGELHUPF  
 EN GUGELHUPF  
 IT GUGELHUPF  
 ES GUGELHUPF

☑ #	115347
Formen/cups	35 x 80 ml
Ø mm	60
↑ mm	30



☑ #	115310
Formen/cups	35 x 90 ml
Ø mm	72
↑ mm	35



DE CREME-FORM  
 EN YULE LOG  
 IT TRONCHETTO  
 ES TRONCO

☑ #	115311
Formen/cups	4 x 2137 ml
Ø mm	495 x 80
↑ mm	63



DE	BISKUIT	<b>400 x 600 mm</b>
EN	SPONGE CAKE	
IT	PAN DI SPAGNA	
ES	BIZCOCHOS	

<input checked="" type="checkbox"/> #	115345
Formen/cups	15 x 341 ml
Ø mm	105
↑ mm	40

<input checked="" type="checkbox"/> #	115313
Formen/cups	12 x 112 ml
Ø mm	120
↑ mm	10

<input checked="" type="checkbox"/> #	115340
Formen/cups	12 x 120 ml
Ø mm	120
↑ mm	22



DE	BISKUIT
EN	SPONGE CAKE
IT	PAN DI SPAGNA
ES	BIZCOCHOS

DE	RINNE	<b>400 x 600 mm</b>
EN	FLUTING	
IT	TRONCHETTO	
ES	TRONCO RECTANGULAR	

<input checked="" type="checkbox"/> #	115344
Formen/cups	8 x 382 ml
Ø mm	140
↑ mm	25

<input checked="" type="checkbox"/> #	115312
Formen/cups	6 x 200 ml
Ø mm	160
↑ mm	10

<input checked="" type="checkbox"/> #	115315
Formen/cups	4 x 2401 ml
↔ mm	495 x 70
↑ mm	70



DE	RINNE
EN	FLUTING
IT	TRONCHETTO
ES	TRONCO RECTANGULAR PEQUEÑO

DE	GRUSTELLO
EN	GRUSTELLO
IT	GRUSTELLO
ES	GRUSTELLO

DE	ERBSEN	<b>400 x 600 mm</b>
EN	PEA	
IT	PISELLI	
ES	GUISANTES	

<input checked="" type="checkbox"/> #	115316
Formen/cups	8 x 445 ml
↔ mm	500 x 30
↑ mm	30

<input checked="" type="checkbox"/> #	115317
Formen/cups	28 x 103 ml
Ø mm	52 x 52
↑ mm	61

<input checked="" type="checkbox"/> #	115318
Formen/cups	24 x 107 ml
↔ mm	117 x 29,5
↑ mm	34



DE	KUBUS
EN	KUBUS
IT	CUBO
ES	CUBO

<input checked="" type="checkbox"/> #	115321
Formen/cups	24 x 103 ml
↔ mm	118 x 30
↑ mm	32



DE	SURFEN
EN	SURF
IT	SURF
ES	SURF

<input checked="" type="checkbox"/> #	115322
Formen/cups	24 x 100 ml
↔ mm	118 x 33
↑ mm	36



DE	EISBOMBE
EN	ICE BOMBE
IT	BOMBA DI GELATO
ES	BOMBA DE HELADO

<input checked="" type="checkbox"/> #	115324
Formen/cups	24 x 106 ml
Ø mm	120 x 36
↑ mm	33



DE	DREIECK
EN	TRIANGLE
IT	TRIANGOLO
ES	TRIÁNGULO

<input checked="" type="checkbox"/> #	115325
Formen/cups	24 x 109,5 ml
↔ mm	120 x 36,5
↑ mm	31



DE	KUGELN
EN	BALLS
IT	BALLSFERE
ES	BOLAS

<input checked="" type="checkbox"/> #	115326
Formen/cups	24 x 106 ml
↔ mm	120 x 35
↑ mm	30



DE	TETRIS
EN	TETRIS
IT	TETRIS
ES	TETRIS

<input checked="" type="checkbox"/> #	115327
Formen/cups	24 x 106 ml
↔ mm	120 x 36
↑ mm	28



DE	FLÖTE
EN	FLUTE
IT	FLAUTO
ES	FLAUTA

<input checked="" type="checkbox"/> #	115328
Formen/cups	24 x 104 ml
↔ mm	119 x 35
↑ mm	32



DE	DELIKATESSE
EN	DELICACY
IT	DELICATEZZA
ES	DELICADEZA

<input checked="" type="checkbox"/> #	115330
Formen/cups	24 x 103 ml
↔ mm	119 x 36
↑ mm	34



DE	SKYLINE
EN	SKYLINE
IT	SKYLINE
ES	SKYLINE

<input checked="" type="checkbox"/> #	115331
Formen/cups	28 x 104 ml
↔ mm	52 x 52
↑ mm	60



DE	SÜSSE ECKE
EN	SWEET CORNER
IT	ANGOLO DOLCE
ES	RINCÓN DULCE

<input checked="" type="checkbox"/> #	115333
Formen/cups	28 x 102 ml
↔ mm	52 x 52
↑ mm	51



DE	SCHIFFCHEN
EN	BOAT
IT	BARCHETTA
ES	BARQUITA

<input checked="" type="checkbox"/> #	115334
Formen/cups	30 x 34 ml
Ø mm	105 x 45
↑ mm	15



DE	ECLIPSE
EN	ECLIPSE
IT	ECLISSE
ES	ECLIPSE

400 x 600 mm

<input checked="" type="checkbox"/> #	115335
Formen/cups	28 x 100 ml
Ø mm	70
↑ mm	35



DE	WAFFEL
EN	WAFFLE
IT	CIALDA
ES	WAFFLE

<input checked="" type="checkbox"/> #	115336
Formen/cups	20 x 113 ml
Ø mm	95 x 70
↑ mm	24



DE	ZYLINDER
EN	CYLINDER
IT	CILINDRO
ES	CILINDROS

<input checked="" type="checkbox"/> #	115343
Formen/cups	24 x 133 ml
Ø mm	70
↑ mm	35

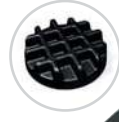

DE	WAFFEL
EN	WAFFLE
IT	CIALDA
ES	WAFFLE

400 x 600 mm

<input checked="" type="checkbox"/> #	115349
Formen/cups	18 x 107 ml
Ø mm	90
↑ mm	24



DE	DONUTS
EN	DONUTS
IT	DONUTS
ES	DONUTS

400 x 600 mm

<input checked="" type="checkbox"/> #	115350
Formen/cups	24 x 133 ml
Ø mm	85
↑ mm	29





**INZELNE TORTENFORMEN AUS SILIKON**

Material: hochwertiges und lebensmittelechtes Silikon, mit Antihafwirkung – kein vorheriges Einfetten mehr notwendig!  
 Temperaturbereich: –60 bis +230 °C (für Backöfen, Mikrowelle oder Gefrierschränke)

Bei richtiger Anwendung sind folgende Punkte zu beachten:

- Backgut immer abkühlen lassen.
- Backformen niemals in direkten Kontakt mit Herdplatten, Feuer oder Grill bringen (am besten die Backformen auf Gitter oder Backbleche auflegen)
- Niemals das Backgut mit scharfen Gegenständen heraustrennen
- Niemals aggressive Reinigungsmittel verwenden, sondern von Hand reinigen

**SINGLE CAKE MOULDS MADE OF SILICONE**

Made of high quality and non-sticking silicone – without prior greasing!  
 Temperature range: from –60 to +230 °C (for ovens, microwaves and freezers)

For optimal using please note the following points:

- Let cool down the products before extraction
- Never use baking moulds on heat sources (fire, grill, electric plates)
- Never use sharp objects to remove your products from the moulds
- Never use aggressive detergents to clean moulds after use, just clean by hand





DE	KÖNIGSKUCHEN
EN	PLUM CAKE
IT	PLUMCAKE
ES	PLUMCAKE

<input checked="" type="checkbox"/> #	115050
↔ mm	240 x 105
↑ mm	65

<input checked="" type="checkbox"/> #	115095
↔ mm	260 x 100
↑ mm	70

<input checked="" type="checkbox"/> #	115096
↔ mm	300 x 100
↑ mm	70



DE	GUGELHUPF
EN	GUGELHUPF
IT	GUGELHUPF
ES	GUGELHUPF

DE	GLATT
EN	PLAIN
IT	LISCIO
ES	REDONDO, LISO

<input checked="" type="checkbox"/> #	115184
↔ mm	200
↑ mm	90

<input checked="" type="checkbox"/> #	115097
↔ mm	220
↑ mm	110

<input checked="" type="checkbox"/> #	115043	115044
↔ mm	260	280
↑ mm	45	45



DE	GEZACKT
EN	SERRATED
IT	FESTONATA
ES	REDONDO, RIZADO

DE	HERZ
EN	HEART
IT	CUORE
ES	CORAZÓN

<input checked="" type="checkbox"/> #	115045	115046
↔ mm	260	280
↑ mm	30	30

<input checked="" type="checkbox"/> #	115185
↔ mm	205 x 186
↑ mm	54

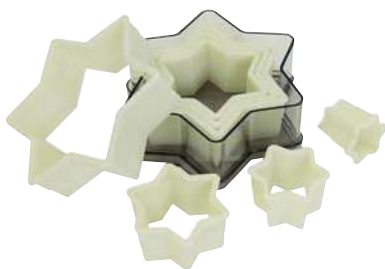

# 166110

DE	AUSSTECHERSÄTZE
EN	SETS OF PASTRY CUTTERS
IT	SET DI TAGLIAPASTA
ES	JUEGOS DE CORTAPASTAS

+160°C

Material: Nylon  
 • Hitzebeständig bis +160°C  
 • Höhe: 35 mm

Made of nylon  
 • Heat resistant up to +160°C  
 • Height: 35 mm

#		Ø mm / ↔ mm	
166100	9-teilig, RUND, glatt / 9 pieces, ROUND, plain	20, 30, 40, 50, 60, 70, 80, 90, 100	
166101	9-teilig, RUND, gezackt / 9 pieces, ROUND, serrated	20, 30, 40, 50, 60, 70, 80, 90, 100	
166102	9-teilig, QUADRAT, glatt / 9 pieces, SQUARE, plain	19 / 28 / 37 / 47 / 57 / 67 / 76 / 86 / 95	
166103	9-teilig, QUADRAT, gezackt / 9 pieces, SQUARE, serrated	19 / 28 / 37 / 47 / 57 / 67 / 76 / 86 / 95	
166104	7-teilig, HERZ, glatt / 7 pieces, HEART, plain	120 x 115 / 105 x 100 / 90 x 85 / 75 x 70 / 65 x 55 / 45 x 40 / 30 x 25	
166105	7-teilig, HERZ, gezackt / 7 pieces, HEART, serrated	120 x 115 / 105 x 100 / 90 x 85 / 75 x 70 / 65 x 55 / 45 x 40 / 30 x 25	
166106	7-teilig, HALBMOND, glatt / 7 pieces, HALF MOON, plain	69 x 20 / 80 x 28 / 90 x 35 / 98 x 43 / 100 x 50 / 110 x 58 / 114 x 65	
166107	7-teilig HALBMOND, gezackt / 7 pieces, HALF MOON, serrated	69 x 20 / 80 x 28 / 90 x 35 / 98 x 43 / 100 x 50 / 110 x 58 / 114 x 65	
166108	7-teilig, OVAL, glatt / 7 pieces, OVAL, plain	21 x 10 / 35 x 20 / 50 x 30 / 65 x 35 / 80 x 45 / 95 x 55 / 110 x 65	
166109	7-teilig, OVAL, gezackt / 7 pieces, OVAL, serrated	21 x 10 / 35 x 20 / 50 x 30 / 65 x 35 / 80 x 45 / 95 x 55 / 110 x 65	
166110	7-teilig, STERN, glatt / 7 pieces, STAR, plain	130 x 115 / 115 x 100 / 100 x 85 / 85 x 70 / 70 x 60 / 55 x 45 / 40 x 35	
166120	26-teilig „BUCHSTABEN“ / 26 pieces “LETTERS”	15 / 45 x 40	
166121	15-teilig „ZAHLEN“ / 15 pieces “NUMBERS”	15 / 60 x 45	





# 166100



# 166101



# 166102



# 166103



# 166104



# 166105



# 166106



# 166107



# 166108



# 166109



# 166120



# 166121



DE	AUSSTECHEKERSÄTZE
EN	SETS OF PASTRY CUTTERS
IT	SET DI TAGLIAPASTA
ES	JUEGOS DE CORTAPASTAS

Material: Edelstahl

- Materialstärke: 0,4 – 0,5 mm

- Höhe: 30 mm

Made of stainless steel

- Thickness: 0.4 – 0.5 mm

- Height: 30 mm

#		Ø mm / ↔ mm	
199500	9-teilig, RUND, glatt / 9 pieces, ROUND, plain	30, 40, 50, 60, 70, 80, 90, 100, 110	
199501	16-teilig, RUND, glatt / 16 pieces, ROUND, plain	20, 30, 40, 50, 60, 70, 75, 80, 85, 90, 95, 100, 110, 120, 125, 140	
199502	9-teilig, RUND, gezackt / 9 pieces, ROUND, serrated	30, 40, 50, 60, 70, 80, 90, 100, 110	
199503	12-teilig, RUND, gezackt / 12 pieces, Round, serrated	30, 40, 50, 60, 70, 80, 90, 100, 110, 120, 130, 140	
199504	9-teilig, OVAL, glatt / 9 pieces, OVAL, plain	27/34, 35/46, 46/57, 55/66, 65/76, 74/86, 85/94, 95/107, 105/116	
199505	12-teilig, OVAL, glatt / 12 pieces, OVAL, plain	27/34, 33/46, 42/57, 54/68, 65/78, 74/87, 85/97, 92/107, 105/117, 113/127, 121/136, 131/146	
199506	9-teilig, OVAL, gezackt / 9 pieces, OVAL, serrated	27/45, 34/55, 44/57, 53/75, 63/85, 72/94, 84/106, 94/113, 102/117	
199507	12-teilig, OVAL, gezackt / 12 pieces, OVAL, serrated	26/35, 33/46, 45/54, 55/64, 66/74, 71/87, 84/95, 99/105, 102/114, 113/127, 121/136, 131/143	
199508	9-teilig, STERN, glatt / 9 pieces, STAR, plain	37, 51, 64, 82, 95, 110, 122, 134, 149	
199510	9-teilig, HERZ, glatt / 9 pieces, HEART, plain	35, 42, 51, 58, 68, 80, 90, 100, 110	
199511	9-teilig, HERZ, gezackt / 9 pieces, HEART, serrated	58, 68, 80, 90, 102, 110, 123, 130, 140	





DE	AUSSTECHERSÄTZE
EN	SETS OF PASTRY CUTTERS
IT	SET DI TAGLIAPASTA
ES	JUEGOS DE CORTAPASTAS

Material: Edelstahl  
 • Materialstärke: 0,4 mm  
 • Höhe: 50 mm

Made of stainless steel  
 • Thickness: 0.4 mm  
 • Height: 50 mm

#		Ø mm
199513	<b>12-teilig</b> , rund, gezackt / 12 pieces, round, serrated	30, 35, 43, 48, 55, 62, 70, 75, 82, 91, 97, 103



# 199520

Material: Edelstahl  
 • Materialstärke: 0,4 – 0,5 mm  
 • Höhe: 30 mm

Made of stainless steel  
 • Thickness: 0.4 – 0.5 mm  
 • Height: 30 mm

#		Ø mm / ↔ mm
199641	<b>9-teilig</b> , Quadrat, glatt / 9 pieces, Square, plain	25/25, 32/32, 38/38, 45/45, 50/50, 58/58, 67/67, 74/74, 82/82
199642	<b>9-teilig</b> , Blüte, glatt / 9 pieces, Blossom, plain	40, 54, 67, 80, 93, 105, 118, 133, 149
199643	<b>9-teilig</b> , Dreieck, glatt / 9 pieces, Triangle, plain	Seite / side: 42, 53, 61, 71, 80, 90, 103, 110, 124
199520	<b>9-teilig, doppel</b> , rund, glatt und gezackt / <b>9 pieces, double</b> round, plain and serrated	30, 40, 50, 60, 70, 80, 90, 98, 110



DE	DEKOR-AUSSTECHERSÄTZE "GEMISCHTE FORMEN"
EN	SETS OF DECORATING CUTTERS "MIXED"
IT	SET DI TAGLIAPASTA "MISTI"
ES	JUEGOS DE CORTAPASTAS "FIGURAS VARIADAS"

Material: Edelstahl  
 • Materialstärke: 0,3 mm  
 • Dosendurchmesser: 100 mm

Made of stainless steel  
 • Thickness: 0.3 mm  
 • Tin diameter 100 mm

#		↑ mm
199656	12 Stück / 12 pieces	20
199657	10 Stück / 10 pieces	20
199658	10 Stück / 10 pieces	20



DE	DONUT-AUSSTECHER
EN	DOUGHNUT CUTTERS
IT	TAGLIAPASTA PER CIAMBELLE
ES	CORTADONUTS

Material: Edelstahl

Made of stainless steel

#	Ø mm	Ø mm	↓ mm
155009	60	25	20
155010	67	30	17
155011	80	40	20



DE	PETIT-FOURS-AUSSTECHERSATZ
EN	SET OF PETIT-FOUR-CUTTERS
IT	SET DI TAGLIAPASTA (9 PZ.) "PETIT FOURS"
ES	JUEGO DE CORTAPASTAS (9 U.) PARA PETIT FOURS

Material: Edelstahl

Made of stainless steel

- 9-teilig

- 9 pieces

#	
199530	Arche, Kurve, Diamant, Herz, Oval Oval rund, Rund, Rechteck, Quadrat / arch, curve, diamond, heart, oval oval round, round, rectangle, square

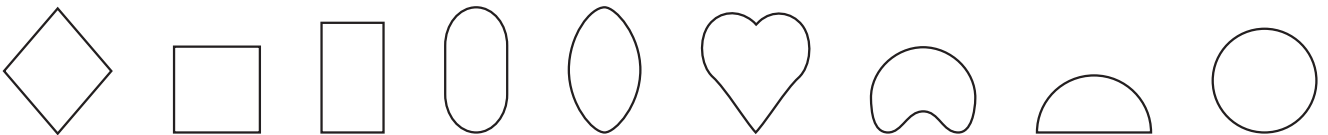

DE	ZIMTSTERN-AUSSTECHER
EN	CINNAMON STAR CUTTER
IT	TAGLIAPASTA "STELLA"
ES	CORTAPASTAS "ESTRELLA"

Material: Edelstahl

Made of stainless steel

- Stabiler Griff
- Federmechanismus

- Solid handle
- Spring mechanism

#	↔ mm	↑ mm
199584	50	97





DE	DEKOR-AUSSTECHECHERSÄTZE
EN	SETS OF DECORATING CUTTERS
IT	SET DI TAGLIAPASTA
ES	JUEGOS DE CORTAPASTAS

Material: Edelstahl  
 • Materialstärke: 0,3 mm

Made of stainless steel  
 • Thickness: 0.3 mm

#		Ø mm	↑ mm	
199650	“GEOMETRIE” 18 Stück / “GEOMETRY” 18 pieces	150	20	
199651	“BLUMEN” 20 Stück / “FLOWERS” 20 pieces	150	20	
199652	“GEMISCHTE FORMEN” 20 Stück / “MIXED” 20 pieces	150	20	
199653	“GEMISCHTE FORMEN” 15 Stück / “MIXED” 15 pieces	130	20	
199654	“GEMISCHTE FORMEN” 14 Stück / “MIXED” 14 pieces	130	20	
199655	“GEMISCHTE FORMEN” 15 Stück / “MIXED” 15 pieces	130	20	
199659	“ZAHLEN” 16 Stück / “NUMBERS” 16 pieces	100	20	
199660	BUCHSTABEN- UND ZAHLENAUSSTECHECHER 40 Stück / ALPHABETH AND NUMBER CUTTERS 40 pieces	150	20	
199661	BUCHSTABENAUSSTECHECHER 26 Stück / ALPHABETH CUTTERS 26 pieces	120	20	
199662	“GEOMETRIE” 24 Stück / “GEOMETRY” 24 pieces Jede Form in 3 ver. Größen / each design in three different sizes	120	20	
199663	“HERZ” 24 Stück / “HEART” 24 pieces Jede Form in 3 ver. Größen / each design in three different sizes	120	20	



# 199650



# 199651



# 199652



# 199653



# 199654



# 199655



# 199659



# 199660



# 199661



# 199662

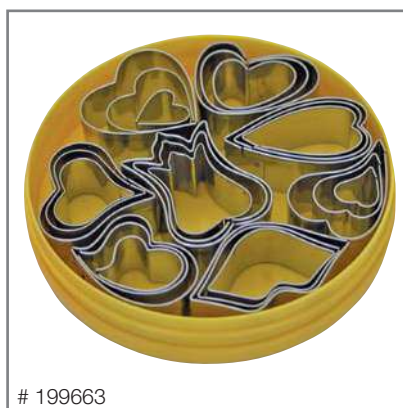

# 199663



DE	DEKOR-AUSSTECHECHERSÄTZE
EN	SETS OF DECORATING CUTTERS
IT	SET DI TAGLIAPASTA
ES	SET DE CORTAPASTAS

Material: Edelstahl

- Materialstärke: 0,3 mm

Made of stainless steel

- Thickness: 0.3 mm

#		Ø mm	↑ mm	
199173	“BLUMEN” 8 Stück, mit Griff / “FLOWERS” 8 pieces, with handle	100	20	
199174	“GEOMETRIE” 8 Stück, mit Griff / “GEOMETRY” 8 pieces, with handle	100	20	
199175	“KARTENSPIEL” 8 Stück, mit Griff / “CARDS” 8 pieces, with handle	100	20	
199176	“GEOMETRIE” 15 Stück / “GEOMETRY” 15 pieces	160	20	
199177	“TIERE” 12 Stück / “ANIMALS” 12 pieces	160	20	
199178	“NIKOLAUS” 3 Stück / “SANTA CLAUS” 3 pieces	100	20	
199179	“TANNEN” 3 Stück / “CHRISTMAS TREES” 3 pieces	100	20	
199180	“KREUZE” 5 Stück / “CROSSES” 5 pieces	100	20	
199181	“GLOCKEN” 5 Stück / “JINGLE BELLS” 5 pieces	100	20	
199182	“SCHNEEFLOCKE” 5 Stück / “SNOWFLAKE” 5 pieces	100	20	
199183	“GEMISCHTE FORMEN” 15 Stück / “MIXED” 15 pieces	100	20	
199184	“BLUMEN” 15 Stück / “FLOWERS” 15 pieces	100	20	





DE	AUSSTECHEMATTEN
EN	CUTTING SHEETS
IT	PLACCHE PASTAFROLLA TAGLIABISCOTTI
ES	PLACAS CORTAPASTAS



Aus hochschlagfestem Kunststoff

- Lebensmittelneutral
- Geruchlos
- Scharfkantig
- Leicht zu säubern
- Aussenabmessungen: 580 x 390 mm

Made of white, impact-resistant plastic

- Odourless
- Warranted free of substances
- Sharp-edged
- Easy to clean
- Outer dimensions: 580 x 390 mm

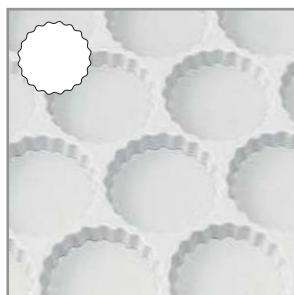

# 166001

1

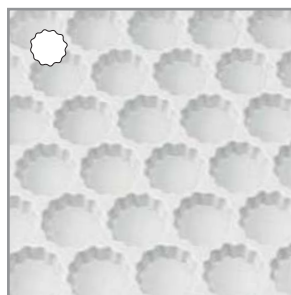

# 166002

2

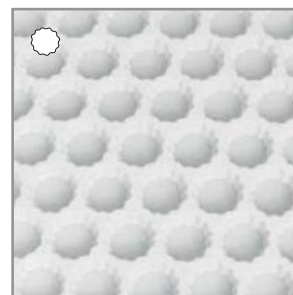

# 166022

2a

#	Nr. / no.	Ø mm		Nutz. / pcs.
166001	1	90	rund gezackt / round, serrated	20
166002	2	45	rund gezackt / round, serrated	72
166022	2a	35	rund gezackt / round, serrated	90
166003	3	53	rund, glatt / round, plain	53
166023	3a	35	rund, glatt / round, plain	95
166004	4	45	Stern / star	63
166024	4a	35	Stern / star	95
166005	5	50	Kleeblatt / four-leaf clover	63
166025	5a	35	Kleeblatt / four-leaf clover	105
166006	6	45	Herz / heart	95
166026	6a	35	Herz / heart	116
166007	7	48	Halbmond / half moon	78
166027	7a	35	Halbmond / half moon	128
166008	8	48	Dreiblatt / clover	68
166028	8a	35	Dreiblatt / clover	105
166009	9	80 / 66	Tanne, Komet / fir tree, comet	50
166010	10	60	Tropfen „Munzenmandeln“ / drop	36
166030	10a	51	Tropfen „Munzenmandeln“ / drop	72
166032	12	60	Glocke / bell	55
166029	13	92	Küken, Hase / chick, rabbit	64
166034	15	63 / 65	Apfel, Birne / appel, pear	25 / 20
166035	16	68 / 78	Schildkröte, Seepferd / turtle, sea horse	20 / 20
166037	18	70 / 75	Seehund, Pinguin / seal, penguin	25 / 16

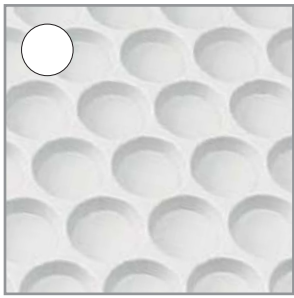

# 166003 3

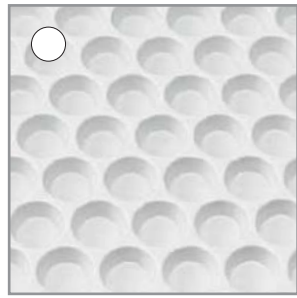

# 166023 3a

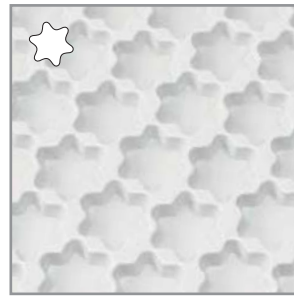

# 166004 4



# 166024 4a



# 166005 5



# 166025 5a

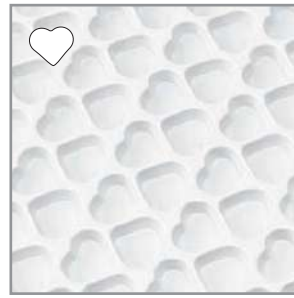

# 166006 6



# 166026 6a



# 166007 7

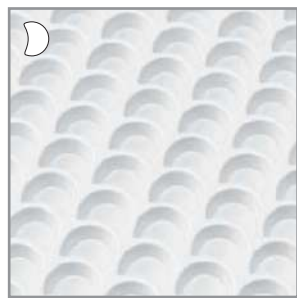

# 166027 7a



# 166008 8



# 166028 8a



# 166009 9

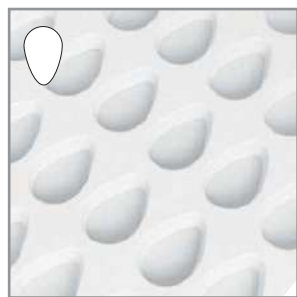

# 166010 10



# 166030 10a



# 166032 12

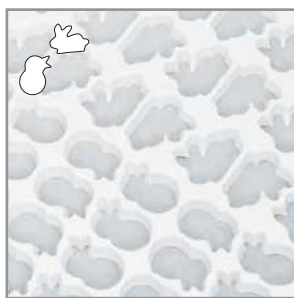

# 166029 13



# 166034 15



# 166035 16

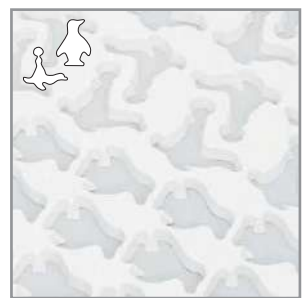

# 166037 18



© Erich Muecke - stock.adobe.com

DE	AUSSTECHEK
EN	CUTTERS
IT	TAGLIAPASTA
ES	CORTAPASTAS

Material: Edelstahl

Made of stainless steel

#		Ø mm / ↔ mm	↑ mm	
199700	rund, glatt / round, plain	Ø 120	30	
199710	rund, glatt / round, plain	Ø 140	30	
199720	rund, gezackt / round, serrated	Ø 120	30	
199730	rund, gezackt / round, serrated	Ø 140	30	
199740	rund, gezackt / round, serrated	Ø 145	30	
199750	quadrat, gezackt / square, serrated	85 x 85	45	
199880	“STERN” / “STAR”	Ø 90	45	
199883	“HERZ” / “HEART”	65 x 60	30	
199884	“TROPFEN” / “TEAR DROP”	90 x 50	30	
199885	“DREIECK KONVEX” / “CONVEX TRIANGLE”	Ø 70	30	
199887	“HERZ” / “HEART”	Ø 90	20	
199888	“BLÜTE” / “BLOSSOM”	Ø 91	20	
199890	“EI” / “EGG”	155 x 100	30	
199891	“EI” / “EGG”	190 x 125	30	
199150	“BANANE” / “BANANA	160	30	



# 199700 + 199710



# 199720 + 199730



# 199740



# 199750



# 199880



# 199883



# 199884



# 199885



# 199887



# 199888



# 199890 + 199891



# 199150



DE	AUSSTECHER
EN	CUTTERS
IT	TAGLIAPASTA
ES	CORTAPASTAS

Material: Edelstahl

Made of stainless steel

#		Ø mm / ↔ mm	↑ mm	
199770	“FISCH” / “FISH”	145 x 65	35	
199886	“IGEL”, 3 Größen / “HEDGEHOG”, 3 sizes	67 / 75 / 90	30	
199163	“SONNENBLUME” / “SUNFLOWER”	Ø: 100	25	
199164	“SCHMETTERLING” / “BUTTERFLY”	Ø: 110	25	
199165	“WEIHNACHTSAUSSTECHER”; glatt mit Böden in 10 versch. Formen (0,3 mm) / “CHRISTMAS-CUTTERS”; plain, with strong base, 10 different types (0.3 mm)	Ø: 50		
199166	“WEIHNACHTSAUSSTECHER”; gewellt mit Böden in 10 versch. Formen (0,3 mm) / “CHRISTMAS-CUTTERS”; waded edges, with strong base, 10 different types (0.3 mm)	Ø: 50		
199167	“WEIHNACHTSAUSSTECHER”; glatt, 8-teilig, bestehend aus: Glocke, Tannenbaum, Schmetterling, Stern, Weihnachtsstern, Ente, Herz und Pilz (0,3 mm) / “CHRISTMAS-CUTTERS”; plain, 8 different types, consisting of: bell, christmas tree, butterfly, star, shooting star, duck, heart and mushroom (0.3 mm)			
199168	“NIKOLAUS”, Materialstärke 0,5 mm / “SANTA CLAUS”, thickness 0.5 mm	230 x 125	30	
199760	“KOMET” / “COMET”	230 x 110	30	
199761	“KOMET”, Set: 3-teilig / “COMET”, set: 3 pieces	87 x 35 127 x 50 167 x 75	20 20 20	
199169	“STERN MIT LOCH”; Materialstärke 0,4 mm / “STAR WITH HOLE”; thickness 0.4 mm	Ø: 105	30	
199170	“STUTENKERL”; Materialstärke 0,5 mm, zweiteilig / “GINGERBREAD MAN”; thickness 0.5 mm, two parts	250 x 220	30	





DE	AUSSTECHEK
EN	CUTTERS
IT	TAGLIAPASTA
ES	CORTAPASTAS

Material: Edelstahl

Made of stainless steel

#		↔ mm	↑ mm	
199780	“SCHNEEMANN” / “SNOW MAN”	145 x 80	30	
199790	“NIKOLAUSSTIEFEL” / “CHRISTMAS BOOT”	140 x 110	30	
199800	“ENGEL” / “ANGEL”	140 x 100	30	
199171	“TANNENBAUM” / “CHRISTMAS TREE”	150 x 125	30	
199172	“TANNENBAUM” / “CHRISTMAS TREE”	200 x 153	30	
199820	“GLOCKE” / “JINGLE BELL”	130 x 110	30	
199860	“HASE” / “RABBIT”	180 x 80	30	
199870	“HASE” / “RABBIT”	200 x 170	30	
199850	“HASENKOPF” / “RABBIT HEAD”	170 x 125	30	
199830	“MARTINSGANS” / “GOOSE”	170 x 215	30	
199840	“ENTE” / “DUCK”	200 x 170	30	

Material: Weißblech

Made of tin

#		
199570	ZAHLENAUSSTECHEK, Set mit 9 Zahlen (von 0 – 9) / NUMBER CUTTERS, set with 9 numbers (from 0 to 9)	
199571	WEIHNACHTSAUSSTECHEK, Set mit 10 verschiedenen Ausstechern / CHRISTMAS CUTTERS, set with 10 different cutters	







 Logo möglich / Private branding possible

DE	TEIGSCHABER FLEXIBEL	<b>SOFT</b>
EN	DOUGH SCRAPERS FLEXIBLE	
IT	RASCHIETTI FLESSIBILI	
ES	RASQUETAS FLEXIBLES	

Material: LDPE, weiß  
 • Hitzebeständig bis ca. +100°C  
 • Materialstärke: 2,5 mm

Made of LDPE, white  
 • Heat resistant up to approx. +100°C  
 • Thickness: 2.5 mm

#	↔ mm
227240	148 x 99
227241	137 x 86
227242	160 x 120
227243	120 x 86
227244	120 x 88



DE	TEIGABSTECHER MIT GRIFFLEISTE
EN	SCRAPERS WITH REINFORCED GRIP
IT	RASCHIETTI CON MANIGLIA RINFORZATA
ES	RASQUETAS CON EMPUÑADURA REFORZADA

#	↔ mm	
227350	221 x 130 mm	eckig / with edges
227351	209 x 130 mm	rund / round edges
227364	125 x 100 mm	eckig / with edges
227230	120 x 100 mm	eckig / with edges

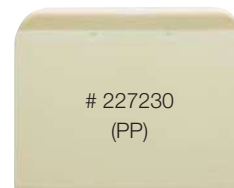

DE	TEIGSCHABER
EN	DOUGH SCRAPERS
IT	RASCHIETTI
ES	RASQUETAS

#	↔ mm	
227352	128 x 90	asymmetrisch / asymmetrical
227355	120 x 80	Creмесchaber / Cream scraper
227356	151 x 102	Creмесchaber / Cream scraper
227360	112 x 78	Kamm / Comb
227365	116 x 78	rund / round
227231	137 x 86	Creмесchaber / Cream scraper
227232	120 x 88	Creмесchaber / Cream scraper
227235	105 x 105 x 105	Kamm / Comb

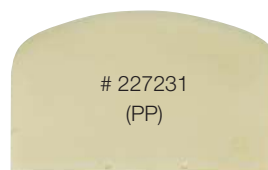
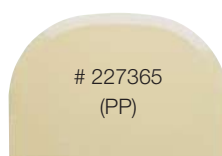
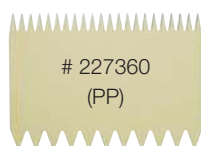
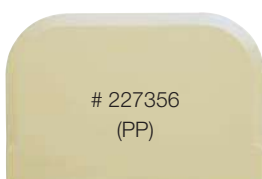
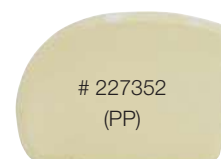

DE	KESSELSCHABER
EN	BOWL SCRAPERS
IT	RASCHIETTI PER BASTARDELLE
ES	RASQUETAS PARA CALDEROS

#	↔ mm
227363	204 x 151
227233	160 x 120

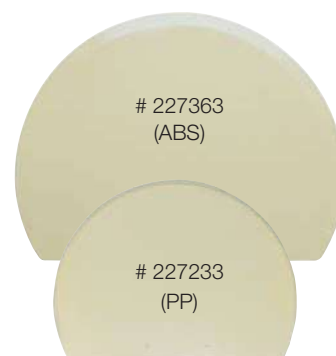

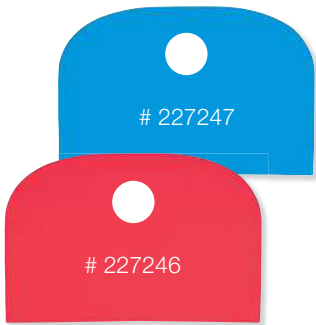

DE	TEIGSCHABER "SCHLESINGER" – FLEXIBEL	<b>SOFT</b>
EN	DOUGH SCRAPERS "SCHLESINGER" – FLEXIBLE	
IT	RASCHIETTI FLESSIBILI	
ES	RASQUETAS FLEXIBLES	

Material: LDPE  
 • Hitzebeständig bis ca. +100°C  
 • Materialstärke: 2,5 mm

Made of LDPE  
 • Heat resistant up to approx. +100°C  
 • Thickness: 2.5 mm

#	↔ mm		
227246	148 x 99	● rot / red	
227247	148 x 99	● blau / blue	

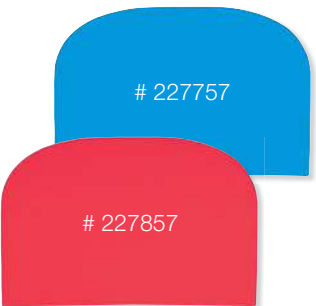

DE	TEIGSCHABER FLEXIBEL	<b>SOFT</b>
EN	DOUGH SCRAPERS FLEXIBLE	
IT	RASCHIETTI FLESSIBILI	
ES	RASQUETAS FLEXIBLES	

Material: LDPE  
 • Hitzebeständig bis ca. +100°C  
 • Materialstärke: 2,5 mm

Made of LDPE  
 • Heat resistant up to approx. +100°C  
 • Thickness: 2.5 mm

#	↔ mm		
227857	148 x 99	● rot / red	
227757	148 x 99	● blau / blue	

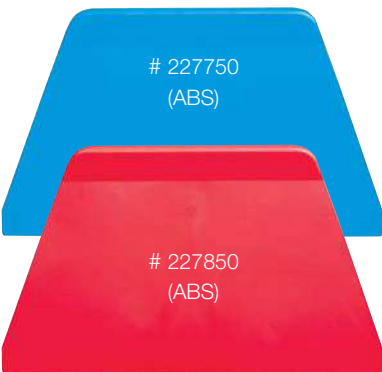

DE	TEIGSCHABER
EN	DOUGH SCRAPERS
IT	RASCHIETTI
ES	RASQUETAS

#	↔ mm		
227850	221 x 130	● eckig / with edges	
227863	204 x 151	● Kessel / Bowl scraper	
227852	128 x 90	● asymmetrisch / asymmetrical	
227856	151 x 102	● Cremeschaber / Cream scraper	
227750	221 x 130	● eckig / with edges	
227763	204 x 151	● Kessel / Bowl scraper	
227752	128 x 90	● asymmetrisch / asymmetrical	
227756	151 x 102	● Cremeschaber / Cream scraper	

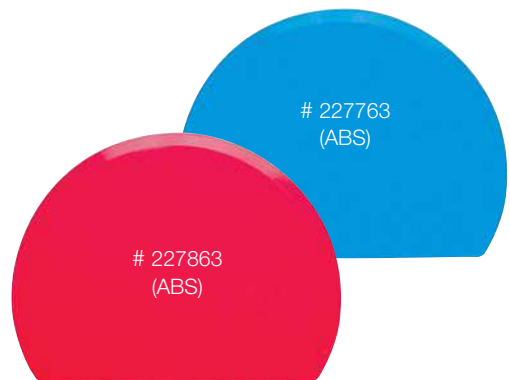
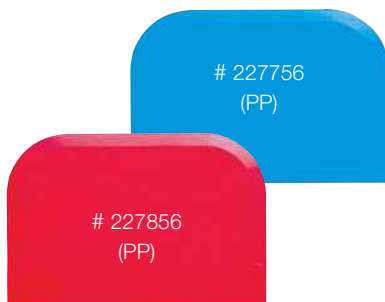
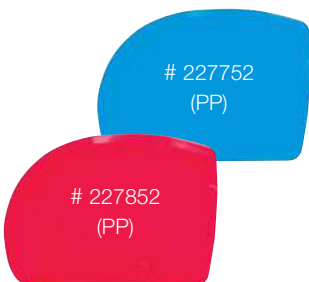

DE	ABSTECHER
EN	SCRAPERS
IT	RASCHIE, INOX
ES	CORTANTE

Material: Edelstahl  
 • Kunststoffgriff  
 • Ecken abgerundet

Made of stainless steel  
 • Plastic handle  
 • Round edges

#	↔ mm	
200600	110 x 120	● flexible Klinge / flexible blade
199070	110 x 120	○ flexible Klinge / flexible blade
199075	110 x 120	● flexible Klinge / flexible blade
200601	110 x 120	● steife Klinge / stiff blade
200602	130 x 135	● steife Klinge / stiff blade



# 200600



# 199070



# 199075

Material: Edelstahl  
 • Kunststoffgriff blau

Made of stainless steel  
 • Blue plastic handle

#	↔ mm	
200702	195 x 145	Trapez / trapezoidal
200703	160 x 170	Rechteck / rectangular

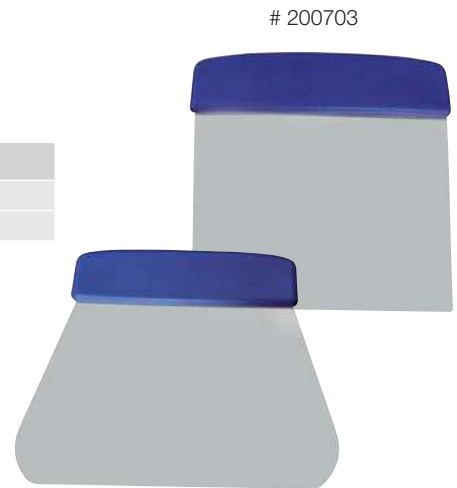

# 200702

DE	SCHABER EDELSTAHL
EN	SCRAPERS STAINLESS STEEL
IT	RASCHIETTI, INOX
ES	RASQUETAS, INOX

Material: Edelstahl

Made of stainless steel

#	↔ mm	
154840	100 x 100	Quadrat / square
154841	110 x 110	Dreieck / triangular
154842	110 x 75	Rechteck / rectangular

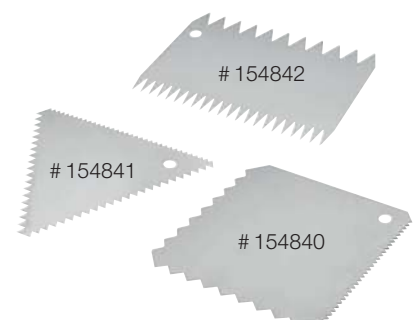



DE	SPACHTELN
EN	SPATULAS
IT	SPATOLE
ES	ESPÁTULAS

Material: Edelstahl  
 • Kunststoffgriff schwarz (PP)

Made of stainless steel  
 • Black plastic handle (PP)

#	→ mm
<input checked="" type="checkbox"/> 200500	40
<input checked="" type="checkbox"/> 200501	60
<input checked="" type="checkbox"/> 200502	80
<input checked="" type="checkbox"/> 200503	100
<input checked="" type="checkbox"/> 200504	120

Material: Edelstahl  
 • Griff Kunststoff (PS)

Made of stainless steel  
 • Plastic handle (PS)

#	→ mm
<input checked="" type="checkbox"/> 200700	170
<input checked="" type="checkbox"/> 200701	270



DE	ABSTECHER
EN	SCRAPERS
IT	RASCHIE, INOX
ES	CORTANTES

Material: Edelstahl  
 • Runder Griff

Made of stainless steel  
 • With round handle

#	↔ mm
200620	125 x 105
200621	150 x 105
200622	175 x 105

Material: Edelstahl  
 • Materialstärke: 0,8 mm

Made of stainless steel  
 • Thickness: 0.8 mm

#	↔ mm	
200610	120 x 115	flach / flat
200611	120 x 110	abgerundet / oblique

DE	SPACHTEL – EXTRA STABIL
EN	SPATULA – EXTRA STRONG
IT	SPATOLA – EXTRA RESISTENTE
ES	ESPÁTULA – EXTRA RESISTENTE

Material: Edelstahl  
 • Griff Kunststoff  
 • Speziell für Schokolade

Made of stainless steel  
 • Plastic handle  
 • Especially for chocolate

#	→ mm
<input checked="" type="checkbox"/> 200710	180

DE	STIELSCHABER
EN	SPATULAS
IT	SPATOLE
ES	ESPÁTULAS

- Material: Silikon
- Mit Metallstiel
  - Hitzebeständig bis + 300 °C

- Made of silicone
- With metal handle
  - Heat resistant up to + 300 °C

#	↔ mm	↗ mm
☑ 200925	● 28 x 60	210
☑ 200926	● 55 x 85	285
☑ 200927	● 70 x 115	325
☑ 200928	○ 55 x 85	285
☑ 200929	○ 70 x 115	325

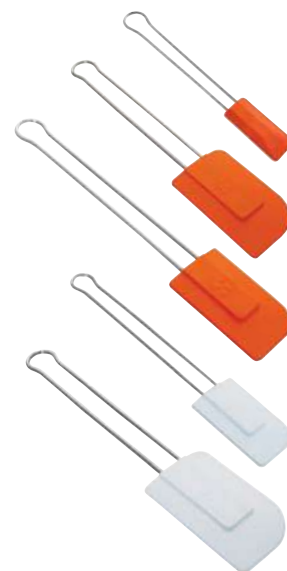

- Material: Silikon
- Griff aus hitzebeständigem Kunststoff bis + 260 °C
  - Mit Aufhängeöse

- Made of silicone
- Handle made of heatresistant plastic, up to + 260 °C
  - With hanging hole

#	↔ mm	↗ mm
☑ 200750	85 x 53	250
☑ 200751	115 x 68	350
☑ 200752	115 x 68	450



DE	STIELSCHABER – LÖFFEL
EN	SPATULAS – SPOON
IT	SPATOLE CUCCHIAIO
ES	ESPÁTULAS CUCHARA

- Material: Silikon
- Griff aus hitzebeständigem Kunststoff bis + 260 °C
  - Mit Aufhängeöse

- Made of silicone
- Handle made of heatresistant plastic up to + 260 °C
  - With hanging hole

#	↔ mm	↗ mm
☑ 200760	116 x 68	250
☑ 200761	116 x 68	350
☑ 200762	116 x 68	450



DE	STIELSCHABER MIT THERMOMETER
EN	SPATULA WITH THERMOMETER
IT	SPATOLE CON TERMOMETRO
ES	ESPÁTULA CON TERMOMETRO

- Hitzebeständiges Silikon
- Auflösung: 0,1° C
- Genauigkeit: +/- 1°C (0° C / +100°C), sonst +/- 1%
- Fühlerlänge: 235 mm
- Inklusive Batterie

- Heat-resistant silicone
- Resolution: 0.1° C
- Accuracy: +/- 1°C (0° C / +100°C) otherwise +/- 1%
- Probe length: 235 mm
- Battery included

#	°C	↔ mm
☑ 160015	-50 / +300	320 x 65





DE	STIELSCHABER
EN	SPATULAS
IT	SPATOLE
ES	ESPÁTULAS

Schaber: Gummi  
Griff: Holz  
Scraper: rubber  
Handle: wood

#	↗ mm	
200770	270	
200771	285	
<input checked="" type="checkbox"/> 200772	320	
<input checked="" type="checkbox"/> 200773	390	



Material: PP, weiß  
• Ideal fürs Kuchenlösen in beschichteten Backformen  
Made of PP, white  
• Ideal for loosening cakes in coated baking moulds

#	↗ mm	→ mm	↑ mm
227099	220	35	6



Material: PP, weiß  
• Aus einem Stück  
• Sehr stabil  
Made of PP, white  
• Made of one piece  
• Very strong

#	↗ mm	→ mm	↑ mm
<input checked="" type="checkbox"/> 200420	300	55	15
<input checked="" type="checkbox"/> 200423	340	55	15



Stiel: ABS, blau  
Schaber: Gummi, weiß  
• Extra stabil  
Handle made of ABS, blue  
Scraper made of rubber, white  
• Extra strong

#	↗ mm	→ mm	↑ mm
<input checked="" type="checkbox"/> 200424	310	60	15



DE	ABSTECHER
EN	CUTTERS
IT	TAGLIAPASTA
ES	CORTAPASTAS

Material: SAN, weiß  
Made of SAN, white

#	↗ mm
227002	230



DE	RÜHRSPATEL	
EN	SPATULAS	PA
IT	SPATOLE	
ES	ESPÁTULAS PARA DILUIR	



#	↗ mm	→ mm	↑ mm
<input checked="" type="checkbox"/> 200940	250	50	15
<input checked="" type="checkbox"/> 200941	300	55	15
<input checked="" type="checkbox"/> 200942	350	55	15
<input checked="" type="checkbox"/> 200943	400	65	20
<input checked="" type="checkbox"/> 200944	450	70	20
<input checked="" type="checkbox"/> 200945	500	75	20



6

DE	KONDITORLÖFFEL
EN	SPOONS
IT	CUCCHIAONI IN LEGNO
ES	CUCHARAS

Material: Buchenholz

Made of beech wood

#	↗ mm
203429	300
203430	350
203431	400
203432	450
203433	500
203434	600



DE	MASSENRÜHRSPATEL
EN	SPATULAS
IT	SPATOLE IN LEGNO
ES	ESPÁTULAS PARA DILUIR

Material: Buchenholz

Made of beech wood

#	↗ mm
203435	350
203436	400
203437	500





DE	STIPPROLLER
EN	ROLLER DOCKERS
IT	RULLI BUCASFOGLIA
ES	RODILLOS PARA PINCHAR HOJALDRE

Material: Edelstahl / Aluminium  
 • Mit ergonomischem Kunststoffgriff

Made of stainless steel and aluminium  
 • With ergonomic plastic handle

#	→ mm
154104	120 mm



Material: Kunststoff (POM), elfenbein  
 • Mit verstärktem Kunststoffgriff

Made of plastic (POM), ivory  
 • With reinforced plastic handle

#	→ mm
<input checked="" type="checkbox"/> 200001	65
<input checked="" type="checkbox"/> 200002	120

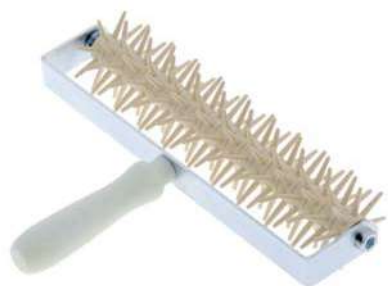

Material: Kunststoff (POM), elfenbein  
 • Ergonomischer Griff  
 • Halterung aus Metall

Made of plastic (POM), ivory color  
 • Ergonomic plastic handle  
 • Mounting made of steel

#	→ mm
200182	270



DE	STRUDELWALZEN
EN	CUTTING ROLLERS
IT	RULLI TAGLIAPASTA (PER STRUDEL)
ES	RODILLOS PARA CORTAR LA MASA

Material: Edelstahl  
 • Mit ergonomischem Kunststoffgriff

Made of stainless steel  
 • With ergonomic plastic handle

#	→ mm
154300	65

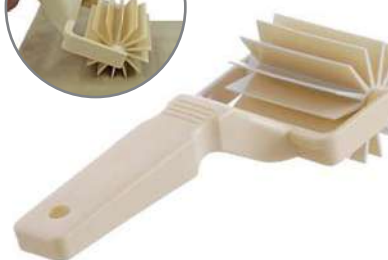

Material: Kunststoff (POM), elfenbein  
 • Mit verstärktem Kunststoffgriff  
 • Für Mürb- oder Hefeteig

Made of plastic (POM), ivory  
 • With reinforced plastic handle  
 • For short crust pastry and yeast dough

#	→ mm
<input checked="" type="checkbox"/> 200003	65

DE	GITTERSCHNEIDER
EN	LATTICE CUTTING ROLLERS
IT	RULLI PER LOSANGHE
ES	RODILLOS ROMBO

Material: Edelstahl

- Mit ergonomischem Kunststoffgriff
- Schneideabstand ca. 7 mm

Made of stainless steel

- With ergonomic plastic handle
- Distance between blades 7 mm



#	→ mm
154203	120

Material: Kunststoff (POM), elfenbein

- Mit verstärktem Kunststoffgriff

Made of plastic (POM), ivory

- With reinforced plastic handle

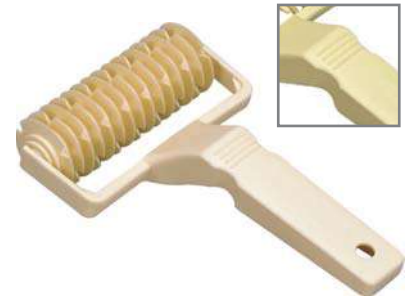

#	→ mm
<input checked="" type="checkbox"/> 200004	65
<input checked="" type="checkbox"/> 200114	120

6

DE	DREIECK-AUSSTECHWALZEN
EN	TRIANGULAR CROISSANT CUTTERS
IT	RULLI TAGLIA CROISSANTS
ES	RODILLOS PARA CORTAR CROISSANTS

Material: Edelstahl

- Ergonomischer Kunststoffgriff
- Für Croissants

Made of stainless steel

- Ergonomic plastic handle
- For croissants



#		mm
154420	einfach / single	a=110, h=150
154421	einfach / single	a=180, h=140
154422	einfach / single	a=180, h=200
154424	einfach / single	a= 70, h=100
154499	einfach / single	a= 97, h=210
154427	doppelt / double	a=180, h=200
154430	dreifach / triple	a=180, h=200
154429	dreifach / triple	a=180, h=140

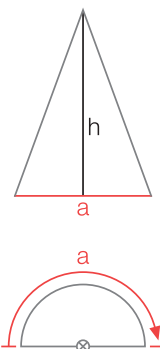

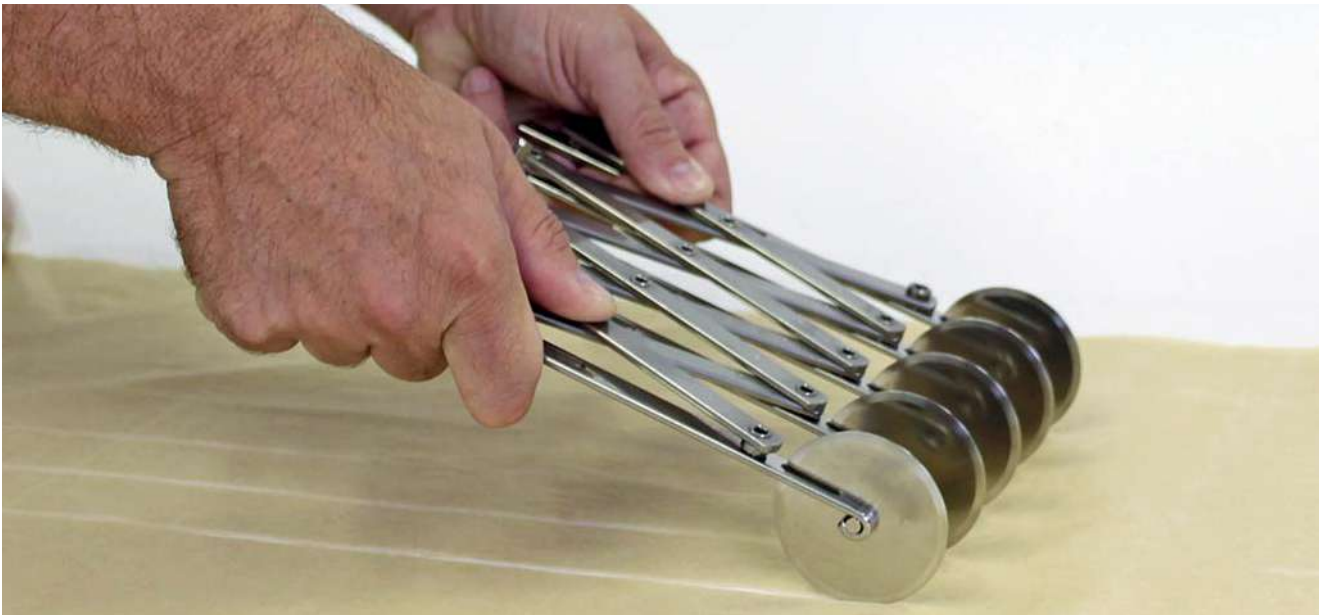

DE	TEIGSCHNEIDER „RUCK-ZUCK“
EN	EXPANDABLE DOUGH CUTTERS
IT	TAGLIAPASTA ESTENSIBILE (BICICLETTA), INOX
ES	CORTAPASTAS EXTENSIBLE – BICICLETA



- Messer: Edelstahl
- Rostfrei
  - Sehr stabile Ausführung
  - Schnittbreite max. 125 mm
  - Rädchen-Durchmesser 55 mm

- Blades made of stainless steel
- Very strong quality
  - Width between wheels max. 125 mm
  - Wheel diameter 55 mm

#		
153100	5 Rädchen glatt / 5 wheels plain	
153110	5 Rädchen gezackt / 5 wheels serrated	
153200	7 Rädchen glatt / 7 wheels plain	
153210	7 Rädchen gezackt / 7 wheels serrated	
153204	Flügelschraube mit Mutter / wing screw with nut	



#		
153300	5 Rädchen glatt und gezackt / 5 wheels plain and serrated	
153400	7 Rädchen glatt und gezackt / 7 wheels plain and serrated	
153204	Flügelschraube mit Mutter / wing screw with nut	

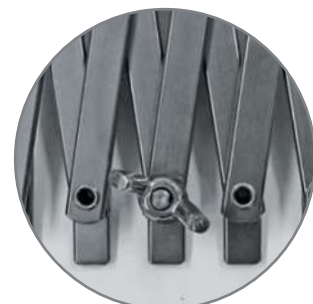

DE	TEIGSCHNEIDER
EN	DOUGH CUTTER
IT	TAGLIAPASTA ESTENSIBILE CON BASE FISSA
ES	CORTAPASTAS REGULABLE CON BARRA FIJA

- Material. Edelstahl
- Rostfrei
  - 8 Messer (gefedert)
  - Stange 70 cm
  - Inklusive Skala 60 cm
  - Messerdurchmesser 5,5 cm

- Made of stainless steel
- 8 blades (spring-loaded)
  - Rod 70 cm
  - Engraved scale 60 cm
  - Diameter of blades 5,5 cm

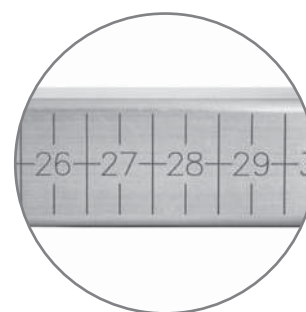

#		kg
153450	Komplett = 8 Rädchen glatt und Stange / complete set = 8 wheels plain and rod	1,2
153451	Ersatzstange / extra rod	
153452	Ersatzmesser / extra blade	



6

DE	TEIG- UND PIZZASCHNEIDER
EN	DOUGH AND PIZZA CUTTERS
IT	ROTELLE TAGLIAPASTA E TAGLIAPIZZA
ES	RULETAS CORTAMASA-CORTAPIZZA

- Material: Edelstahl
- Kunststoffgriff mit Handschutz
  - Aufhängeöse
  - Sehr robuste Ausführung

- Made of stainless steel
- Plastic handle and hook
  - With hand protection
  - Very strong quality

#		Ø mm
<input checked="" type="checkbox"/> 200005	einfach, glatt / single, plain	55
<input checked="" type="checkbox"/> 200006	einfach gewellt / single serrated	55
<input checked="" type="checkbox"/> 200007	doppelt glatt und gewellt / double, plain and serrated	55
<input checked="" type="checkbox"/> 200115	einfach, glatt / single, plain	100



- Material: Edelstahl
- Mit ergonomischem Griff aus schwarzem PP; ca. 255 mm lang

- Made of stainless steel
- Ergonomic handle made of black PP; ca. 255 mm length



#		Ø mm
200116	einfach, glatt / single, plain	125

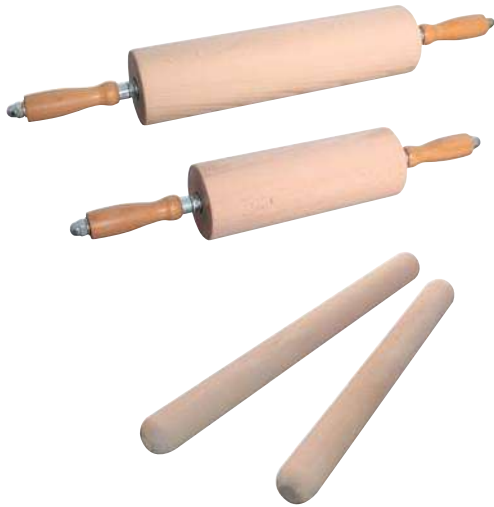

DE	ROLLHÖLZER / TEIGROLLE
EN	ROLLING PINS
IT	RULLI IN LEGNO
ES	RODILLOS DE AMASAR EN MADERA

Material: Buchenholz  
 • Mit Präzisionskugellager

Made of beech wood  
 • With precision ball-bearing

#	→ mm (Walze / roller)	Ø mm	⚖️ kg
200160	250	90	1,4
200161	300	90	1,7
200162	350	90	1,9
200163	400	90	2,1
200164	450	90	2,3

#	↗ mm	Ø mm
203300	420	45
203310	500	45

Material: PE, weiß  
 • Hygienisch  
 • Einfach zu reinigen  
 • Mit Edelstahlwelle

Made of PE, white  
 • Hygienic  
 • Easy to clean  
 • Shaft stainless steel



#	→ mm (Walze / roller)	Ø mm	⚖️ kg
200126	300	80	1,9
200127	400	80	2,0
200128	450	80	2,3
200129	500	80	2,5

Material: PE, weiß

Made of PE, white



#	↗ mm	Ø mm	⚖️ kg
200096	300	48	0,8
200097	400	48	0,9
200123	500	48	0,6



DE	BROTSTREICHER
EN	BREAD BRUSHES
IT	SPAZZOLE PER PANE
ES	CEPILLOS PARA PAN

Holzstiel, 50% Schweineborste, 50% Kunstborste (Polyester-Faser)  
 • Mit Aufhängeloch

Wooden handle, 50% pig bristles, 50% synthetic bristle  
 • With hanging hole

#	↗ mm	
<input checked="" type="checkbox"/> 200234	245	4-reihig / 4 rows
<input checked="" type="checkbox"/> 200235	320	5-reihig / 5 rows
<input checked="" type="checkbox"/> 200236	410	6-reihig / 6 rows
<input checked="" type="checkbox"/> 200237	460	7-reihig / 7 rows

**Stabiler Kunststoffkörper mit glatter Oberfläche**, hochwertige Polyester-Borsten  
 • Hitzebeständig bis 134°C  
 • Mit Aufhängeloch

**Stable plastic body with smooth surface**, high-quality polyester bristles  
 • Heat resistant up to 134°C  
 • With hanging hole



#	↗ mm	
<input checked="" type="checkbox"/> 120810	400	○
<input checked="" type="checkbox"/> 120811	400	●
<input checked="" type="checkbox"/> 120812	400	●

DE	MEHLBESEN
EN	FLOUR BRUSHES
IT	SPAZZOLE PER FARINA
ES	CEPILLOS PARA HARINA

**Holzrücken, 100% Rosshaar**

**Wooden handle, 100% horsehair**

#	↗ mm		
200238	300	hellbraun / beige	
200239	300	schwarz / black	

**Kunststoffrücken, Rosshaarmischung (50% Rosshaar und 50% Synthetik PVC)**

**Grip made of plastic, horsehair mixture (50% horsehair and 50% synthetic PVC)**

#	↗ mm		
200260	300	hellbraun / beige	
200261	300	schwarz / black	

**Stabiler Kunststoffkörper mit glatter Oberfläche, hochwertige Polyester-Borsten**  
 • Hitzebeständig bis 134°C  
 • Mit Aufhängeloch

**Stable plastic body with smooth surface, high-quality polyester bristles**  
 • Heat resistant up to 134°C  
 • With hanging hole

#	↗ mm		
<input checked="" type="checkbox"/> 120800	300		○
<input checked="" type="checkbox"/> 120801	300		●
<input checked="" type="checkbox"/> 120802	300		●



6

DE	REINIGUNGSBÜRSTE
EN	CLEANING BRUSH
IT	SPAZZOLA DI PULIZIA
ES	CEPILLO DE LIMPIEZA

• Holzgriff  
 • Borstenfläche ca. 13 x 2,5 cm

• Wooden handle  
 • Bristle area approx. 13 x 2.5 cm

#		↗ mm	
<input checked="" type="checkbox"/> 120950	Messingdraht / Brass wire	285	
<input checked="" type="checkbox"/> 120960	Stahldraht / Carbon steel	285	



DE	BACKOFENBESEN
EN	OVEN BROOMS
IT	SPAZZOLONI DA FORNO
ES	CEPILLOS PARA HORNO

• Hitzebeständig bis + 300 °C  
 • Extra dicht besteckt  
 • Naturfaser

• Heat resistant up to + 300 °C  
 • Natural fabric

#	↔ mm		
120650	500	Besen mit Metallschaber / broom with metal scraper	
120653	500	Besen / broom	
120651	1900	Stiel / stick	



DE	PINSEL
EN	BRUSHES
IT	PENNELLI
ES	PINCELES

Weißer Borsten, lebensmittelunbedenklich  
(70% Kunstborste PBT/PP und  
30% Naturschweineborste)  
• Holzstiel mit Aufhängeöse

White bristles, food safe (70% synthetic  
bristles PBT/PP and 30% natural pig  
bristles)  
• Wooden handle with hole



#	→ mm
<input checked="" type="checkbox"/> 200200	10
<input checked="" type="checkbox"/> 200201	15
<input checked="" type="checkbox"/> 200202	20
<input checked="" type="checkbox"/> 200203	25
<input checked="" type="checkbox"/> 200204	30
<input checked="" type="checkbox"/> 200205	35
<input checked="" type="checkbox"/> 200206	40
<input checked="" type="checkbox"/> 200207	50
<input checked="" type="checkbox"/> 200208	60
<input checked="" type="checkbox"/> 200209	80
<input checked="" type="checkbox"/> 200210	100

#	→ mm	Zoll / inch
<input checked="" type="checkbox"/> 200212		1/2"
<input checked="" type="checkbox"/> 200213		3/4"
<input checked="" type="checkbox"/> 200214		1"
<input checked="" type="checkbox"/> 200215		1 1/2"
<input checked="" type="checkbox"/> 200216		2"
<input checked="" type="checkbox"/> 200217		2 1/2"
<input checked="" type="checkbox"/> 200218		3"
<input checked="" type="checkbox"/> 200219		4"



Weißer Borsten, lebensmittelunbedenklich  
(70% Kunstborste PBT/PP und  
30% Naturschweineborste)  
• Kunststoffstiel mit Aufhängeöse

White bristles, food safe (70% synthetic  
bristles PBT/PP and 30% natural pig  
bristles)  
• Handle made of plastic with hanging hole

#	→ mm
<input checked="" type="checkbox"/> 200271	25
<input checked="" type="checkbox"/> 200272	30
<input checked="" type="checkbox"/> 200273	35
<input checked="" type="checkbox"/> 200274	40
<input checked="" type="checkbox"/> 200275	50
<input checked="" type="checkbox"/> 200276	60
<input checked="" type="checkbox"/> 200280	75

DE	PINSEL "SILIKON"
EN	BRUSHES "SILICONE"
IT	PENNELLI IN SILICONE
ES	PINCELES EN SILICONA

Material: Silikon, mit Metallstiel  
• 5-reihig  
• Bis + 300 °C

Made of silicone, with metal handle  
• 5 rows  
• Up to + 300 °C



#	→ mm	↗ mm
<input checked="" type="checkbox"/> 200313	35	230
<input checked="" type="checkbox"/> 200312	42	235
<input checked="" type="checkbox"/> 200299	50	280



DE	PINSEL
EN	BRUSHES
IT	PENNELLI
ES	PINCELES

Weißer Borsten, lebensmittelunbedenklich  
(50% Kunstborste PBT/PP und  
50% Naturschweineborste)

- Kunststoffstiel mit Aufhängeöse (PA)

With hanging hole, white bristles, food safe  
(50% synthetic bristles PBT/PP and  
50% natural pig bristles)

- Handle made of plastic (PA)

#	→ mm
<input checked="" type="checkbox"/> 200290	40
<input checked="" type="checkbox"/> 200291	50
<input checked="" type="checkbox"/> 200292	60
<input checked="" type="checkbox"/> 200293	75



Borsten  
in zwei  
Qualitäten

**Superweiche Polyester-Borsten weiß**

- Stiel PA

**Super soft white polyester bristles**

- Handle made of plastic (PA)

#	→ mm
<input checked="" type="checkbox"/> 202294	40
<input checked="" type="checkbox"/> 202295	50
<input checked="" type="checkbox"/> 202296	60
<input checked="" type="checkbox"/> 202297	75



6

Nylonborsten, rot

- Schwarzer Kunststoffgriff mit Aufhängeöse
- Bis 150 °C hitzebeständig

Made of nylon, red bristles

- Plastic handle with hole
- Heat-resistant up to +150 °C



#	→ mm
<input checked="" type="checkbox"/> 200285	25
<input checked="" type="checkbox"/> 200286	35
<input checked="" type="checkbox"/> 200287	50
<input checked="" type="checkbox"/> 200288	60



DE	BROTFORMEN / GÄRKÖRBE
EN	BREAD PROOFING BASKETS
IT	CESTE DA LIEVITAZIONE PER PANE
ES	CESTOS DE FERMENTACIÓN DE PAN (BANNETONES)

Material: Peddigrohr

Made of rattan

#		 g	↑ mm *	 mm *	
<b>▼ geflochtener Boden / plaited bottom</b>					
201200	Rund / round	500	75	Ø 190	
201205	Rund / round	750	80	Ø 200	
201210	Rund / round	1000	85	Ø 220	
201220	Rund / round	1500	90	Ø 250	
201230	Rund / round	2000	95	Ø 290	
201300	Oval	500	80	240 x 140	
201302	Oval	250	85	200 x 120	
201305	Oval	750	80	260 x 150	
201310	Oval	1000	95	260 x 160	
201320	Oval	1500	90	320 x 180	
201330	Oval	2000	105	360 x 200	
201400	Lang, runder Kopf / long, round shape	500	90	240 x 130	
201410	Lang, runder Kopf / long, round shape	1000	90	340 x 130	
201420	Lang, runder Kopf / long, round shape	1500	90	430 x 130	
201430	Lang, runder Kopf / long, round shape	2000	95	460 x 150	
201440	Lang, runder Kopf / long, round shape	3000	95	500 x 170	
201450	Lang, runder Kopf / long, round shape	300	55	410 x 95	
201451	Lang, runder Kopf / long, round shape	500	55	460 x 100	
201500	Lang, eckiger Kopf / long, angled shape	1000	85	320 x 130	
201510	Lang, eckiger Kopf / long, angled shape	1250	90	360 x 130	
201520	Lang, eckiger Kopf / long, angled shape	1500	85	380 x 140	
201850	Dreieck / triangle	500	80	180 x 180 x 180	
201851	Dreieck / triangle	1000	80	210 x 210 x 210	
201852	Quadrat / square	1000	80	220 x 220	
<b>▼ Holzboden / wooden bottom</b>					
201600	Lang, runder Kopf / long, round shape	500	75	240 x 120	
201610	Lang, runder Kopf / long, round shape	1000	90	340 x 130	
201620	Lang, runder Kopf / long, round shape	1500	90	430 x 130	
201630	Lang, runder Kopf / long, round shape	2000	90	460 x 150	
201700	Lang, eckiger Kopf / long, angled shape	1000	85	320 x 130	
201710	Lang, eckiger Kopf / long, angled shape	1250	85	360 x 130	
201720	Lang, eckiger Kopf / long, angled shape	1500	90	380 x 140	
201730	Lang, eckiger Kopf / long, angled shape	2000	90	440 x 140	
<b>▼ Holzboden speziell für Schnittenbrot / wooden bottom, especially for sandwich bread</b>					
201800	Lang, eckiger Kopf / long, angled shape	3000	95	500 x 160	
201810	Lang, eckiger Kopf / long, angled shape	4000	100	550 x 160	
201820	Lang, eckiger Kopf / long, angled shape	5000	100	600 x 160	
201830	Lang, eckiger Kopf / long, angled shape	6000	100	650 x 160	

\* Circa-Abmessungen, können leicht abweichen / \* Approximate dimensions, may vary slightly



6



DE	BROTFORMEN / GÄRKÖRBE	NICHT zum Backen geeignet! NOT for baking!
EN	BREAD PROOFING	
IT	CESTE DA PANE	
ES	CESTOS DE FERMENTACIÓN DE PAN	

- Material: PP
- Hygienisch
  - Lebensmittelrecht
  - Spülmaschinenfest
  - Reinigungsfreundlich durch undurchlässige Oberfläche
  - Stapelbar

- Made of PP
- Hygienic
  - Food safe
  - Dishwasher-proof
  - Easy cleaning due to impermeable surface
  - Stackable

#		g	mm
201000	● rund / round	500	Ø 190
201010	● rund / round	1000	Ø 220
201020	● rund / round	1500	Ø 250
201030	● rechteckig / rectangular	500	120 x 270
201040	● rechteckig / rectangular	1000	130 x 350
201050	● rechteckig / rectangular	1500	140 x 420



DE	GÄRTÜCHER
EN	COTTON LINERS
IT	TELE COPRICESTA
ES	PAÑOS PARA CESTOS DE FERMENTACIÓN DE PAN

- Material: 95 % Baumwolle, 5 % Elastomer, weiß in 3 Größen
- Mit normalem Waschmittel ohne Weichspüler und Bleichmittel bis 40°C waschbar

- Material: cotton 95%, elastomer 5% white in 3 sizes
- Can be washed up to 40°C with normal detergent without softener and bleach

#		mm
201901	für runde Gärkörbe / for round bread proofing baskets	190
201902	für runde Gärkörbe / for round bread proofing baskets	220
201903	für runde Gärkörbe / for round bread proofing baskets	250
201904	für rechteckige Gärkörbe / for rectangular bread proofing baskets	120 x 270
201905	für rechteckige Gärkörbe / for rectangular bread proofing baskets	130 x 350
201906	für rechteckige Gärkörbe / for rectangular bread proofing baskets	140 x 420



DE	HANDBÜRSTE SPEZIELL ZUM REINIGEN VON GÄRKÖRBE
EN	CLEANING BRUSH FOR BREAD PROOFING BASKETS
IT	SPAZZOLA PER LA PULIZIA DELLE CESTE DA LIEVITAZIONE
ES	CEPILLOS PARA LIMPIEZA DE CESTOS DE FERMENTACIÓN DE PAN

Griff aus Holz; Borsten Polyester      Wooden handle, bristles made of polyester

#	mm
201907	135 x 40 x 70

DE	BROT- UND BRÖTCHENDRÜCKER / TEIGDRÜCKER
EN	BREAD AND DOUGH MARKERS / DOUGH MARKERS
IT	STAMPI PER PANE, ROSETTA
ES	MARCADOR DE PAN ROSETA

Material: Edelstahl  
 • Stabiler Griff

Made of stainless steel  
 • Solid handle

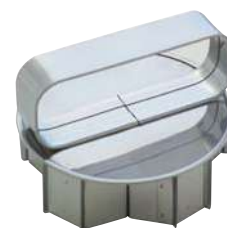

#	Ø mm	↑ mm	
199585	80	57	5-eckig / 5 square
199586	160	57	5-eckig / 5 square
199580	80	57	ohne Loch / without hole
199581	65	57	ohne Loch / without hole
199582	80	57	mit Loch / with hole



6

Material: Kunststoff, weiß

Made of plastic, white

#	
166080	Kaisersemmel gerade / straight
166081	Kaisersemmel
166082	Kaisersemmel mit Loch / with hole
166083	Spirale / spiral



DE	KAISERSEMMELEDRÜCKER
EN	"KAISERSEMMELE", MARKERS
IT	STAMPI PER PANE, KAISER
ES	MARCADOR DE PAN DE VIENA

Material: Kunststoff, weiß

Made of white plastic

#	Ø mm	↗ mm
191095	64	200





DE	FLACHBESEN	
EN	FLAT WHISK	
IT	FRUSTA PIATTA	
ES	BATIDOR PLANO	

- Speziell für das Unterheben von schweren Massen und Saucen, Cremes und Mehl
  - Auch bestens für Fettgebäck geeignet
  - Especially for mixing heavy masses and sauces, creams and flour
  - Also ideally suitable for fatty pastries
- Drahtstärke: 2,0 mm**      **Wire thickness: 2.0 mm**

#	↗ mm	Drähte / Wires
<input checked="" type="checkbox"/> 170079	270	4



DE	SCHNEEBESEN	
EN	WHISKS	
IT	FRUSTE	
ES	BATIDORES	

- Schwarzer thermoplastischer Griff
  - Drähte aus Edelstahl
  - Wasserdichter Griff
  - Mit Aufhängeöse
  - Schwere Qualität
  - Hitzebeständig bis 200°C
  - Black thermoplastic handle
  - Wires made of stainless steel
  - Waterproof handle
  - With suspension eye
  - Heavy quality
  - Heat resistant up to 200°C
- Drahtstärke: 1,6 mm**      **Wire thickness: 1.6 mm**

#	↗ mm	Drähte / Wires
<input checked="" type="checkbox"/> 170080	250	24
<input checked="" type="checkbox"/> 170081	300	24
<input checked="" type="checkbox"/> 170082	350	24
<input checked="" type="checkbox"/> 170083	400	24
<input checked="" type="checkbox"/> 170084	450	24
<input checked="" type="checkbox"/> 170085	500	24



- Material: Edelstahl      Made of stainless steel
- Handlicher Griff
  - Für leichte Massen
  - Easy-to-hold handle
  - For light masses
- Drahtstärke: 1,6 mm**      **Wire thickness: 1.6 mm**

#	↗ mm	Drähte / Wires
<input checked="" type="checkbox"/> 170040	250	24
<input checked="" type="checkbox"/> 170041	300	24
<input checked="" type="checkbox"/> 170042	350	24
<input checked="" type="checkbox"/> 170043	400	24
<input checked="" type="checkbox"/> 170044	450	24



- BALLONFORM
  - Schwarzer Kunststoffgriff "Exoglass"
  - Drähte aus Edelstahl
  - Wasserdichter Griff
  - Griffbund verhindert abrutschen
  - Hitzebeständig bis 220 °C
  - BALLOON-SHAPE
  - Black plastic handle "Exoglass"
  - Wires made of stainless steel
  - Waterproof handle
  - Handle band prevents slipping
  - Heat resistant up to 220 °C
- Drahtstärke: 1,5 mm**      **Wire thickness: 1.5 mm**

#	↗ mm	Drähte / Wires
170016	450	24

DE	RÜHRBESEN	
EN	WHISKS	
IT	FRUSTE	
ES	BATIDORES	

- Schwarzer thermoplastischer Griff
- Drähte aus Edelstahl
- Wasserdichter Griff
- Mit Aufhängeöse
- Schwere Qualität
- Hitzebeständig bis 200°C

**Drahtstärke: 2,0 mm**

- Black thermoplastic handle
- Wires made of stainless steel
- Waterproof handle
- With suspension eye
- Heavy quality
- Heat resistant up to 200°C

**Wire thickness: 2.0 mm**

#	↗ mm	Drähte / Wires
<input checked="" type="checkbox"/> 170070	250	16
<input checked="" type="checkbox"/> 170071	300	16
<input checked="" type="checkbox"/> 170072	350	16
<input checked="" type="checkbox"/> 170073	400	16
<input checked="" type="checkbox"/> 170074	450	16
<input checked="" type="checkbox"/> 170075	500	16



Material: Edelstahl

- Handlicher Griff
- Für schwere Massen

**Drahtstärke: 2,3 mm**

Made of stainless steel

- Easy-to-hold handle
- For heavy masses

**Wire thickness: 2.3 mm**

#	↗ mm	Drähte / Wires
<input checked="" type="checkbox"/> 170050	350	16
<input checked="" type="checkbox"/> 170051	400	16
<input checked="" type="checkbox"/> 170052	450	16
<input checked="" type="checkbox"/> 170053	500	16
<input checked="" type="checkbox"/> 170054	600	16



6

- Schwarzer Kunststoffgriff "Exoglass"
- Drähte aus Edelstahl
- Wasserdichter Griff
- Griffbund verhindert abrutschen
- Hitzebeständig bis 220 °C

**Drahtstärke: 1,8 mm**

- Black plastic handle "Exoglass"
- Wires made of stainless steel
- Waterproof handle
- Handle band prevents slipping
- Heat resistant up to 220 °C

**Wire thickness: 1.8 mm**

#	↗ mm	Drähte / Wires
170010	250	12
170011	300	16
170012	350	16
170013	400	16
170014	450	18
170015	500	18





DE	FRÜCHTE ABLAUF-SET, RUND	
EN	FRUIT STAINER SET, ROUND	<b>SET</b>
IT	SET COLAFRUTTA	
ES	JUEGO DE COLADOR PARA FRUTA	

Material: PP, weiß

- Bruchsicher
- Hygienisch
- Sieb mit praktischem Griff
- Alle Komponenten einzeln erhältlich

Made of PP, white

- Break resistant
- Hygienic
- Strainer with 2 handles
- Each part available separately

#		Ø mm	l
290040	Schüssel/round bowl	360	9,0
200022	Seiher/strainer	280	



DE	RÜHRSCHÜSSELN	
EN	MIXING BOWLS	
IT	CIOTOLE	
ES	CALDEROS	

Material: PP, natur-weiß

- Bruchsicher
- Hygienisch
- Stapelbar
- Auch für Mikrowellengeräte geeignet

Made of PP, natural white

- Break resistant
- Hygienic
- Stackable
- Usable also for microwave

#	l	Ø mm	↑ mm
290000	1,0	190	79
290010	2,5	240	115
290020	4,5	280	135
290030	6,0	325	147
290040	9,0	360	165
290050	13,0	400	185



DE	DECKEL	
EN	LIDS	
IT	COPERCHI	
ES	TAPAS	

Material: PP

Made of PP



#	für / for #	Ø mm
290070	290000 (1,0 l)	190
290071	290010 (2,5 l)	240
290072	290020 (4,5 l)	280
290073	290030 (6,0 l)	325
290074	290040 (9,0 l)	360
290075	290050 (13,0 l)	400



DE	TEIGWANNE – RECHTECKIG
EN	DOUGH CONTAINER – RECTANGULAR
IT	CONTENITORI PER IMPASTO RETTANGOLARI
ES	CUBETAS RECTANGULARES PARA MASA



Material: PP, weiß

- Robuste und praktische Teigwanne mit 2 Griffen, ohne Deckel
- Ideal für Transportwagen 600 x 400 mm
- Stapelbar (mit Deckel # 202181)

Made of PP, white

- Robust and practical dough container with 2 handles, without lid
- Ideal for transport trolleys 600 x 400 mm
- Stackable (with lid # 202181)



#	↔ mm	⏏ mm	⏏ l
202180	600 x 400 x 82	500 x 300 x 77	13



DE	DECKEL FÜR TEIGWANNE – RECHTECKIG
EN	LID FOR DOUGH CONTAINER – RECTANGULAR
IT	COPERCHIO PER CONTENITORI PER IMPASTO RETTANGOLARI
ES	TAPA DE LA CUBETAS RECTANGULARES PARA MASA



Material: PP, weiß

- Deckel für # 202180
- Beidseitig verwendbar
- Stapelbar

Made of PP, white

- Lid for # 202180
- Usable on both sides
- Stackable

#	↗ mm	→ mm	↑ mm
202181	600	400	35



DE	TEIGWANNEN RECHTECKIG
EN	DOUGH CONTAINERS RECTANGULAR
IT	CONTENITORI PER IMPASTO RETTANGOLARI
ES	CUBETAS RECTANGULARES PARA MASA

Material: HDPE, weiß

- Ohne Deckel

Made of HDPE, white

- Without lid

#	↔ mm	⏏ mm	⏏ l
200960	530 x 410 x 140	440 x 320 x 130	20
200962	440 x 320 x 155	395 x 275 x 150	12
200963	610 x 440 x 150	550 x 375 x 145	25



DE	TEIGWANNEN RUND
EN	DOUGH CONTAINERS ROUND
IT	CONTENITORI PER IMPASTO TONDI
ES	CUBETAS REDONDAS PARA MASA

Material: HDPE, weiß

- Ohne Deckel

Made of HDPE, white

- Without lid

#		∅ ↑ mm	↑ mm	⏏ l
200970	mit Griff / with handle	450	185	14
200971	ohne Griff / without handle	480	170	19





DE	SCHÜSSELN
EN	BOWLS
IT	BACINELLE
ES	CALDEROS

Material: PP, weiß  
 • Tiefe Form

Made of PP, white  
 • Deep form

#	Ø mm	↑ mm	↻ l
221020	160	78	0,75
221021	200	96	1,6
221022	240	110	2,6
221023	280	125	4,5
221024	320	140	6,5
221025	360	162	9,5
221026	400	168	12,5



DE	SEIHER
EN	STRAINER
IT	COLAPASTA
ES	COLADOR

Material: PP, weiß  
 • 2 Muschelgriffe, passende Schüssel  
 # 221026 + 290040

Made of PP, white  
 • 2 shell shaped handles, suitable bowls  
 # 221026 + 290040

#	↑ Ø mm	↓ Ø mm	↑ mm
200022	360	280	185



DE	KASSEROLLE
EN	SAUCEPAN
IT	CARAFFA GRADUATA
ES	CAZO DE POLIPROPILENO



Material: PP, weiß  
 • Mit geprägter Skala in Innenseite  
 • Blauer Skalendruck auf der Außenseite  
 • Bruchsicher  
 • Hygienisch  
 • Für Mikrowellengeräte geeignet

Made of PP, with  
 • Inside scale  
 • Blue stamped litre and ml scale outside  
 • Break resistant  
 • Hygienic  
 • Suitable for microwave

#	↗ mm	Ø mm	↑ mm	↻ l
290200	335	190	120	2,0

**i** Ausgießer beidseitig somit für Links- und Rechtshänder geeignet. /  
 Pour spouts on both sides, thus for left- and right-handers.



DE	WANDAUFHÄNGER
EN	WALL RACK
IT	SUPPORTO MURALE PER CONTENITORI
ES	SOPORTE MURAL PARA CONTENEDORES

Weiß beschichtet (Polyamid), passend für Dosen 2,0 l, 3,0 l und 5,0 l (# 230102, 230110 und 230120)  
 • Sehr stabile Ausführung

Coated in white plastic (Polyamide), suitable for containers 2.0 l, 3.0 l and 5.0 l (# 230102, 230110 and 230120)  
 • Solid

#	↗ mm	→ mm	↑ mm
230130	900	190	160

DE	VORRATSDOSEN
EN	STORAGE CONTAINERS
IT	CONTENITORI
ES	CONTENEDORES

Material: PP

- Alle Größen stapelbar
- Bruchstabil
- Dose ohne Deckel

Made of PP

- All sizes stackable
- Break resistant
- Container without lid

#	↗ mm	→ mm	↑ mm	♻️ l
230102	175	140	150	2,0
230112	175	140	210	3,0
230122	175	140	340	5,0



DE	DECKEL FÜR VORRATSDOSEN	
EN	LID FOR STORAGE CONTAINERS	
IT	COPERCHIO PER CONTENITORI	
ES	TAPA PARA CONTENEDORES	

Material: PP

- Bruchstabil

Made of PP

- Break resistant

#	für Artikel / for article
230129	# 230102 / 230112 / 230122



6

DE	VORRATSDOSEN / GEWÜRZDOSEN	
EN	STORAGE CONTAINERS	
IT	CONTENITORI CON COPERCHIO	
ES	CONTENEDORES CON TAPA	

Material: PS, transparent

- Inklusive Deckel
- Spülmaschinengeeignet

Made of PS, transparent

- Including lid
- Dishwasher safe

**Rund**

**Round**

#	Ø mm	↑ mm	♻️ ml
152919	115	140	1000
152915	115	190	1500
152916	115	280	2200



**Quadratisch**

**Square**

#	↗ mm	→ mm	↑ mm	♻️ ml
152920	105	105	140	1000
152917	105	105	190	1450
152918	105	105	280	2000



DE	RÜHRCHÜSSELN	<b>SST</b>
GB	MIXING BOWLS	
IT	BACINELLE CONICHE	
ES	CALDEROS CÓNICOS	



Material: Edelstahl

- **Konische Form**
- Mit abgerundetem Rand
- Glatter Boden
- Gute Standfestigkeit
- Stabil und griffig
- Stapelbar

Made of stainless steel

- **Conical shape**
- With rolled edge
- Smooth bottom
- Good stability
- Stable and non-slip
- Stackable



#	Ø mm	l
199002	160	0,5
199003	180	0,9
199004	200	1,2
199005	225	1,6
199006	235	2,0
199007	280	3,0
199008	320	5,0
199009	360	7,0
199010	395	8,2

DE	SCHLAGSCHÜSSELN	<b>SST</b>
GB	MIXING BOWLS	
IT	BACINELLE SEMISFERICHE	
ES	CALDEROS SEMIESFÉRICOS	



Material: Edelstahl

- **Runde Form**
- Mit abgerundetem Rand
- Glatter Boden
- Gute Standfestigkeit
- Stabil und griffig
- Stapelbar

Made of stainless steel

- **Hemispherical shape**
- With rolled edge
- Smooth bottom
- Good stability
- Stable and non-slip
- Stackable



#	Ø mm (innen/inside)	l
199000	125	0,3
199011	140	0,5
199012	165	0,9
199013	185	1,25
199014	200	1,85
199015	230	2,6
199017	255	3,2
199018	280	4,5
199019	330	6,7

DE	MASCHINENSCHLAGKESSEL	
EN	KETTLE FOR MIXING MACHINE	SST 
IT	CIOTOLA PER MONTARE	
ES	TAZÓN PARA BATIR	

- Mit bordiertem Rand
- With rolled rim

#	Ø mm	↑ mm	 l
199420	260	200	10,0
199421	300	250	16,0
199422	320	300	20,0
199423	360	285	25,0
199424	360	350	32,0
199425	400	355	40,0



DE	HANDSCHLAGKESSEL	
EN	MIXING BOWL	SST 
IT	CIOTOLA PER MONTARE	
ES	TAZÓN PARA BATIR	

- Mit bordiertem Rand
- With rolled rim

#	Ø mm	↑ mm	 l
199400	220	120	2,7
199401	260	140	4,0
199402	320	180	9,5
199403	360	205	14,0
199404	400	215	18,0



6

DE	FUSS	
EN	BASE	SST
IT	BASE	
ES	BASE	

- Passend für Handschlagkessel
- Suitable for mixing bowl

#	Ø mm	↑ mm	für / for #
199406	160	40	199400, 199401
199405	220	45	199402, 199403, 199404





DE	TRICHTER
EN	FUNNELS
IT	IMBUTI
ES	EMBUDOS

Material: HDPE, natur

Made of HDPE

- Mit Entlüftungslippen und Aufhängeöse

- With air vent and suspension loop

#	Ø mm	Auslaufende / outlet Ø mm
250001	50	3
250002	60	8
250003	80	11
250004	100	12
250005	120	12
250006	140	15
250007	164	17



- Mit Überlauftrand und Phosphorsieb
- Aufhängeöse

- With overflow rim, phosphorsieve
- Suspension loop

250008	168	17
250009	208	20



DE	DOSIERFLASCHE / ENGHALSFLASCHE
EN	BOTTLES
IT	FLACONI
ES	BOTELLAS



Material: PE, transparent  
• Lebensmittelecht

Made of PE, transparent  
• Food safe

#	l	Ø mm	↑ mm
200194	0,05	28 x 51	79
200195	0,25	61	134
200196	0,5	78	162
200197	1,0	97,5	223,5



DE	SPRÜHFLASCHE
EN	SPRAYING BOTTLES
IT	FLACONI PER BAGNE
ES	BOTELLAS PARA BAÑAR BISCOCHOS



Material: PE, transparent  
• Lebensmittelecht  
• Verschluss gelocht (13 Löcher)  
• Mit Skala

Made of PE, transparent  
• Food-proof  
• Perforated cap (13 holes)  
• With scale

#	l	Ø mm	↑ mm
200192	1,0	70	230

DE	SPRÜHFLASCHEN	
EN	SPRAYING BOTTLES	
IT	FLACONI PER BAGNE	
ES	BOTELLAS PARA BAÑAR BISCOCHOS	

- Material: PE, transparent
- Lebensmittelrecht
  - Verschluss gelocht (21 Löcher)
  - Mit Skala

- Made of PE, transparent
- Food-proof
  - Perforated cap (21 holes)
  - With scale



#	 l	↑ mm	Ø mm
200499	0,75	250	72

DE	DRUCKPUMPENZERSTÄUBER	
EN	COMPRESSED AIR SPRAYER	
IT	POLVERIZZATORE	
ES	PULVERIZADOR MANUAL POR BOMBEO	

Flexibler Druckpumpenzerstäuber für einfaches Versprühen von Flüssigkeit durch Luftdruck.

- Handlich und vielseitig einsetzbar
- Große Flächen können problemlos gleichmäßig eingesprüht werden
- Druckaufbau durch Pumpstange.
- **100% Lebensmittelrecht**

Pressure sprayer for easy and flexible spraying of all liquids by air-pressure.

- Suitable for nearly all liquids
- Large surfaces can be sprayed easily and even
- **100% food safe**



#	↔ mm	 l	
153950	303 x 233 x 135	1,8	4 bar

Flexibler Druckpumpenzerstäuber für einfaches Versprühen von Flüssigkeit durch Luftdruck.

- Handlich und vielseitig einsetzbar
- Große Flächen können problemlos gleichmäßig eingesprüht werden
- Druckaufbau durch Pumpstange
- Druckflussmenge/Förderleistung: 300 ml/min.
- Integrierte Skala
- Für Flüssigkeiten bis +30 °C
- **100% Lebensmittelrecht**

Pressure sprayer for easy and flexible spraying of all liquids by air-pressure.

- Suitable for nearly all liquids
- Large surfaces can be sprayed easily and even
- Pressure flow rate / delivery rate: 300 ml/min.
- Integrated scale
- For liquids up to +30°C
- **100% food safe**



#	↔ mm	 l	
153952	313 x 206 x 119	1,2	3 bar

Die Literangabe bezieht sich bis zur Kante.  
The liter specification refers to the edge.



DE	KONFITÜRENSCHÜSSEL
EN	JAM BOWL
IT	CIOTOLA PER MARMELLATA
ES	CUENCO PARA MERMELADA

- Mit 2 Seitengriffen
- With 2 side handles

#	↑ Ø mm	↓ Ø mm	↑ mm	∩ l	∩ mm
170120	360	300	120	10,0	1,2
170121	380	310	140	13,8	1,2

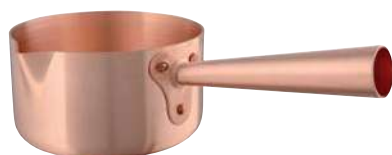

DE	ZUCKERTOPF
EN	SUGAR POT
IT	PENTOLA PER ZUCCHERO
ES	OLLA DE AZÚCAR

- Mit Kupfergriff
- With copper handle

#	Ø mm	↑ mm	∩ l	∩ mm
170135	120	75	0,8	2,0
170136	140	80	1,2	2,0
170137	160	95	1,9	2,0
170138	180	105	2,6	2,0
170139	200	110	3,4	2,0

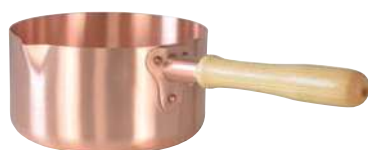

- Mit Holzgriff
- With wooden handle

#	Ø mm	↑ mm	∩ l	∩ mm
170145	160	95	1,9	2,0



DE	ZABAIONESCHÜSSEL
EN	ZABAGLIONE BOWL
IT	CIOTOLA PER ZABAIONE
ES	CUENCO PARA ZABAGLIONE

- Mit Messinggriff
- With brass handle

#	Ø mm	↑ mm	∩ l	∩ mm
170140	160	125	1,9	1,2



Die Literangabe bezieht sich bis zur Kante.  
The liter specification refers to the edge.



DE	SIRUPSCHÜSSEL
EN	SYRUP BOWL
IT	CIOTOLA PER SCIROPPO
ES	CUENCO PARA SIROPE

- Mit 2 Seitengriffen
- With 2 side handles

#	↑ Ø mm	↓ Ø mm	↑ mm	⊞ l	⊞ mm
170116	260	150	125	5,0	1,0
170117	300	170	140	8,5	1,0
170118	350	170	150	10,1	1,0



6



DE	EIWEISSCHÜSSEL
EN	EGG WHITE BOWL
IT	CIOTOLA PER ALBUME D'UOVA
ES	CUENCO PARA CLARA DE HUEVO

- Mit Aufhängering
- With hanging ring

#	Ø mm	↑ mm	⊞ l	⊞ mm
170107	240	130	3,5	1,0
170108	260	140	4,6	1,0
170109	300	165	7,1	1,0
170110	350	165	11,1	1,0
170111	400	195	16,6	1,2



- Mit 2 Seitengriffen
- With 2 side handles

#	Ø mm	↑ mm	⊞ l	⊞ mm
170112	260	130	4,6	1,0
170113	300	165	7,1	1,0
170114	350	165	11,1	1,0
170115	400	195	16,6	1,2



DE	HALTERUNG FÜR SCHÜSSEL	SST
EN	HOLDER FOR BOWL	
IT	SUPPORTO PER CIOTOLA	
ES	SUPPORTE PARA CUENCO	

#	↑ Ø mm	↓ Ø mm	↑ mm	⊞ mm
170101	155	230	105	5,0





DE	MEHL- UND GEWÜRZSCHAUFELN
EN	FLOUR SCOOPS
IT	SESSOLE
ES	RECOGEDORES LIBRADORES PARA HARINA Y CONDIMENTOS

Material: PE, Farbe natur

Made of PE , transparent

#	↗ mm	↻ ml	
200023	187	110	
200024	250	230	
200025	310	470	
200026	350	725	
200027	400	1390	

**i** HACCP-Farben auf Anfrage. / HACCP-colors open request.



Material: PE, schwarz

Made of PE , black

#	↗ mm	↻ ml	
200802	250	230	



© Wolfgang Mücke – stock.adobe.com



DE	MESSCHAUFELN, FREI STEHEND
EN	MEASURING SCOOPS, FREE STANDING
IT	SESSOLE CON BASE PIATTA
ES	RECOGEDORES LIBRADORES CON BASE PLANA

Material: PP, weiß

Made of PP, white

- Ausführung: stehende Schaufel,
- Auch für Flüssigkeiten

- Also execution: free-standing scoops
- Suitable for liquids

#		↗ mm	↻ ml	
200350	○ weiß / white	135	25	
200351	○ weiß / white	160	50	
200352	○ weiß / white	200	100	
200353	○ weiß / white	260	250	
200354	○ weiß / white	315	500	
200355	○ weiß / white	385	1000	
200346	● rot / red	200	100	
200347	● rot / red	260	250	
200348	● blau / blue	200	100	
200349	● blau / blue	260	250	

DE	MEHL- UND GEWÜRZSCHAUFELN
EN	FLOUR SCOOPS
IT	SESSOLE CON BASE PIATTA
ES	RECOGEDORES LIBRADORES PARA HARINA

- Material: Aluguß mit Außengriff
- Aus einem Stück gegossen
  - Sehr stabile Formen, hygienisch

- Made of cast aluminium
- In one piece
  - Solid, hygienic

#	↗ mm	↕ ml	
180202	210	130	
180210	250	250	
180220	265	285	
180230	290	375	
180240	310	450	
180250	335	500	
180260	350	800	
180270	400	1500	
180280	430	2500	
180310	255	350 / 330	
180320	315	650 / 450	
180330	385	1200 / 850	
180340	270	500 / 350	
180350	310	850 / 600	
180360	385	2000 / 1400	

Polierte Oberfläche

Polished surface

#	↗ mm	↕ ml	
<input checked="" type="checkbox"/> 180400	145	90	
<input checked="" type="checkbox"/> 180410	185	150	
<input checked="" type="checkbox"/> 180420	210	180	
<input checked="" type="checkbox"/> 180430	245	355	
<input checked="" type="checkbox"/> 180440 *	310	720	
<input checked="" type="checkbox"/> 180450 *	350	1000	
<input checked="" type="checkbox"/> 180460 *	400	1900	

\* freistehend / free-standing

DE	SACKSCHAUFELN
EN	FLOUR SCOOPS
IT	SESSOLE CON BASE TONDA E MANIGLIA ROVESCATA
ES	RECOGEDORES LIBRADORES PARA HARINA CON MANGO INVERTIDO

- Material: Aluguß mit Außengriff
- Griff genietet
  - Sehr stabile Form, hygienisch

- Made of cast aluminium
- With riveted inverted handle
  - Solid, hygienic

#	↗ mm	↕ ml	
180370	310	2200	

- Material: Edelstahl
- Griff genietet

- Made of stainless steel
- Riveted handle

#	↗ mm	↕ ml	
180380	375	3000	

- Material: Edelstahl
- Mit Außengriff aus Gummi
  - Sehr schwere Ausführung

- Made of stainless steel
- With riveted inverted handle made of rubber
  - Solid

#	↗ mm	↕ ml	
180300	280	2000	





DE	MESSBECHER
EN	MEASURING CUPS
IT	CARAFFE GRADUATE
ES	JARRAS GRADUADAS

- Material: PP, Farbe natur
- Mit geprägter Skala und blauer Skala
  - Liter- und Milliliter-Einteilung
  - Bis 95°C erhitzzbar

- Made of PP, translucent
- With stamped and blue scale
  - Litre and ml scale
  - Temperature resistant up to 95°C

**Mit geschlossenem Griff**

**With closed handle**

#		l	
206010*	ohne Griff / without handle	0,12	
200011	mit geschlossenem Griff / closed handle	0,5	
200012	mit geschlossenem Griff / closed handle	1,0	
200013	mit geschlossenem Griff / closed handle	2,0	
200014	mit geschlossenem Griff / closed handle	3,0	
200015	mit geschlossenem Griff / closed handle	5,0	

**Mit offenem Griff**

**With open handle**

#		l	
200010*	mit offenem Griff / open handle	0,25	
206011	mit offenem Griff / open handle	0,5	
206012	mit offenem Griff / open handle	1,0	
206013	mit offenem Griff / open handle	2,0	
206014	mit offenem Griff / open handle	3,0	
206015	mit offenem Griff / open handle	5,0	

\* nur geprägte Skala

\* only with stamped scale



DE	MESSBECHER-DECKEL
EN	LIDS FOR MEASURING CUPS
IT	COPERCHI PER CARAFFE GRADUATE
ES	TAPAS PARA JARRAS GRADUADAS



#	Deckel für # / Lid for #		
206112	200012 + 206012 / 1,0 l		
206113	200013 + 206013 / 2,0 l		
206114	200014 + 206014 / 3,0 l		
206115	200015 + 206015 / 5,0 l		

DE	MESSBECHER-SET
EN	SET OF MEASURING CUPS
IT	SET DI CARAFFE GRADUATE
ES	SET DE JARRAS GRADUADAS

- Material: PP, Farbe natur
- Mit geprägter Skala und blauer Skala
  - Liter- und Milliliter-Einteilung
  - Bis 95°C erhitzzbar

- Made of PP, translucent
- With stamped and blue scale
  - Litre and ml scale
  - Temperature resistant up to 95°C

**Mit geschlossenem Griff, inklusive Deckel**

**With closed handle, including lid**

#		l	
200408	mit geschlossenem Griff / closed handle	1,0	
200409	mit geschlossenem Griff / closed handle	2,0	



DE	MESSBECHER
EN	MEASURING CUPS
IT	CARAFFE GRADUATE, IMPILABILI
ES	JARRAS GRADUADAS, APILABLES

- Material: PP, Farbe natur
- Mit offenem Griff
  - Stapelbar
  - Liter- und Milliliter-Einteilung
  - Bis 95°C erhitzbar

- Made of PP, translucent
- With open handle
  - Stackable
  - With litre and ml scale
  - Temperature resistant up to 95°C

#	l	
200149	0,5	
200150	1,0	
200170	2,0	
200179	3,0	



DE	GLASURTRICHTER
EN	GLAZE FUNNEL
IT	IMBUTO PER GLASSA
ES	EMBUDO PARA GLASEADO

- Material: Griff und Trichter aus Edelstahl
- Boden: Kunststoff
  - Lochdurchmesser: 5 mm
  - Für flüssiges Fondant mit Dosiermechanik

- Handle and funnel made of stainless steel
- Bottom made of plastic
  - Hole diameter: 5 mm
  - For liquid fondant, dosing mechanism

#	l	Ø mm	↑ mm
199960	1,0	135	150



6



geöffnet – Ansicht von innen  
open – interior view



geöffnet / open



geschlossen / closed

DE	EINHANDSIEB / DRÜCKSIEB FÜR PUDERZUCKER UND KAKAO
EN	SIEVES FOR POWDERED SUGAR AND COCOA
IT	SETACCI PER ZUCCHERO A VELO E CACAO
ES	TAMICES PARA AZÚCAR GLASS Y CACAO

Material: Edelstahl

Made of stainless steel

#	Ø mm
199069	100



DE	MEHLSIEBE, PUDER- UND ZUCKERSIEBE / RUNDSIEBE
EN	FLOUR AND SUGAR SIEVES
IT	SETACCI PER FARINA E ZUCCHERO
ES	TAMICES PARA HARINA Y AZÚCAR

Material: Ring und Metallgewebe aus Edelstahl  
 • Feines Gewebe  
 • Für trockenes Siebgut

Ring and meshes made of stainless steel  
 • Fine meshes  
 • For dry ingredients



	#	Ø mm	↑ mm	⊞ mm	⊚ mm		
<b>B</b>	199210	220	55	0,45	0,22	Mehl, sehr fein/ flour, very fine	
<b>E</b>	199211	220	55	0,60	0,25	Mehl, fein / flour, fine	
<b>F</b>	199212	220	55	0,84	0,28	Mehl, mittel / flour, medium	



<b>B</b>	199220	400	80	0,45	0,22	Mehl, sehr fein/ flour, very fine	
<b>E</b>	199221	400	80	0,60	0,25	Mehl, fein / flour, fine	
<b>F</b>	199222	400	80	0,84	0,28	Mehl, mittel / flour, medium	
<b>L</b>	199223	400	80	6,8	1,0	Streusel, grob / coarse	



<b>A</b>	199052	160	65	0,3	0,16	Mehl, sehr fein/ flour, very fine	
<b>A</b>	199053	190	65	0,3	0,16	Mehl, sehr fein/ flour, very fine	
<b>A</b>	199054	210	65	0,3	0,16	Mehl, sehr fein/ flour, very fine	
<b>A</b>	199055	240	65	0,3	0,16	Mehl, sehr fein/ flour, very fine	
<b>A</b>	199056	260	65	0,3	0,16	Mehl, sehr fein/ flour, very fine	
<b>A</b>	199057	280	65	0,3	0,16	Mehl, sehr fein/ flour, very fine	
<b>A</b>	199058	300	65	0,3	0,16	Mehl, sehr fein/ flour, very fine	

	⊞ mm	⊚ mm
<b>A</b>	0,30	0,16

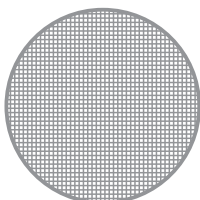

	⊞ mm	⊚ mm
<b>B</b>	0,45	0,22

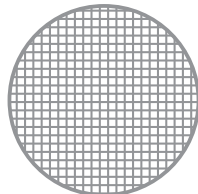

	⊞ mm	⊚ mm
<b>C</b>	0,50	0,20

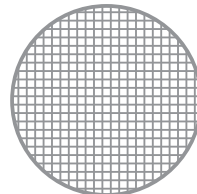

	⊞ mm	⊚ mm
<b>D</b>	0,50	0,5

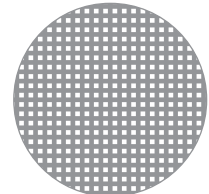

DE	MEHLSIEBE, PUDER- UND ZUCKERSIEBE / RUNDSIEBE
EN	FLOUR AND SUGAR SIEVES
IT	SETACCI PER FARINA E ZUCCHERO
ES	TAMICES PARA HARINA Y AZÚCAR

Material: PP, weiß

- Stabiler Kunststoff
- Mit praktischen Rillen (verhindert das Abrutschen)
- **Keine Metallklammern**
- Spülmaschinentauglich
- Einfach zu reinigen

Made of PP, white

- Solid plastic
- With convenient flutes (avoid slip off)
- **No staples**
- Dishwasher proof
- Easy to clean

Maschen aus Edelstahl

Stainless steel mesh

	#	Ø mm	↑ mm / ↓ mm	⊞ mm	⊞ mm
<b>C</b>	200635	185	107 / 95	0,50	0,20
<b>C</b>	200634	305	115 / 100	0,50	0,20
<b>G</b>	200633	305	115 / 100	0,85	0,24
<b>I</b>	200632	305	115 / 100	1,20	0,28
<b>J</b>	200631	305	115 / 100	1,80	0,34
<b>K</b>	200630	305	115 / 100	2,80	0,45

Maschen aus Nylon

Nylon meshes

	#	Ø mm	↑ mm / ↓ mm	⊞ mm	⊞ mm
<b>D</b>	200240	240	80 / 65	0,5	0,5
<b>H</b>	200241	240	80 / 65	1,0	0,5
<b>D</b>	200300	300	90 / 70	0,5	0,5
<b>H</b>	200301	300	90 / 70	1,0	0,5



6

<b>E</b>	⊞ mm	⊞ mm
	0,60	0,25

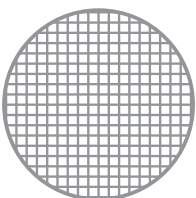

<b>F</b>	⊞ mm	⊞ mm
	0,84	0,28

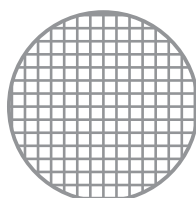

<b>G</b>	⊞ mm	⊞ mm
	0,85	0,24

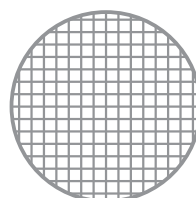

<b>H</b>	⊞ mm	⊞ mm
	1,0	0,50

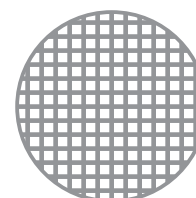

<b>I</b>	⊞ mm	⊞ mm
	1,20	0,28

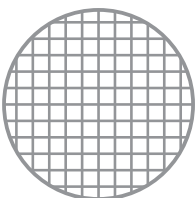

<b>J</b>	⊞ mm	⊞ mm
	1,80	0,34

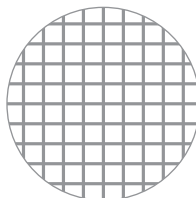

<b>K</b>	⊞ mm	⊞ mm
	2,80	0,45

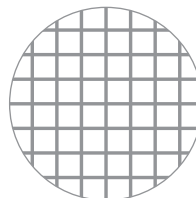

<b>L</b>	⊞ mm	⊞ mm
	6,8	1,0

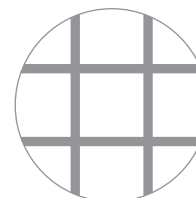



DE	AUSBACKSCHIESSER
EN	OVEN PEELS
IT	PALE PER FORNO
ES	PALAS PARA HORNEAR



Material: Aluminium  
 • Randhöhe: 30 mm  
 • Aufnahme-Stiel: 26 x 26 mm

Made of aluminium  
 • Height of edge: 30 mm  
 • Support shaft: 26 x 26 mm

#	↔ mm
155500	580 x 470



DE	STIELE	
EN	HANDLES	
IT	MANICI	
ES	PALOS	

Material: Buchenholz

Made of beech wood

#	↗ mm
203421	1600
203422	1950



DE	HANDSCHIESSER
EN	OVEN PEELS
IT	PALE PER FORNO
ES	PALAS PARA HORNEAR

Material: Buchenholz

Made of beech wood

#	↗ mm	→ mm
203411	500	120
203412	500	140
203413	500	160
203414	500	180
203415	950	180
203416	950	200
203417*	1150	180
203418*	1150	200



DE	BREZELSCHIESSER
EN	OVEN PEELS
IT	PALE PER FORNO
ES	PALAS PARA HORNEAR

Material: Buchenholz

Made of beech wood

#	↗ mm	→ mm
203419	600 ohne Loch / without holes	140
203420	600 mit Loch / with holes	140



6

DE	AUSBACKSCHIESSER
EN	OVEN PEELS
IT	PALE PER FORNO
ES	PALAS PARA HORNEAR

Material: Buchenholz

Made of beech wood

#	↗ mm	→ mm
203400	500	120
203401	500	140
203402	500	160
203403	500	180
203404	500	200
203405	500	240
203406	500	300
203407	500	320
203408	500	340
203409	600	160
203410	650	200

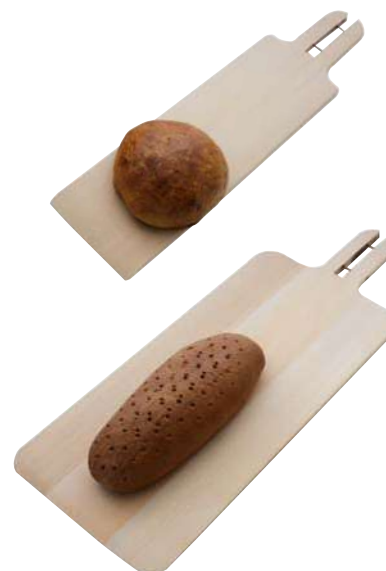



DE	TORTENRINGE RUND
EN	TART RINGS ROUND
IT	ANELLI PER TORTE
ES	AROS PARA TARTAS

Material: Edelstahl

Made of stainless steel

**Mit Borde**

**With folded rim**



#	Ø mm	↑ mm
162080	80	20
162100	100	20
162120	120	20
162140	140	20
162160	160	20
162180	180	20
162200	200	20
162220	220	20
162240	240	20
162260	260	20
162280	280	20
162300	300	20
162320	320	20
162340	340	20

**Ohne Borde**

**Without folded rim**



#	Ø mm	↑ mm
163075	75	40
163080	80	45
163120	120	45
163140	140	45
163160	160	45
163180	180	45
163200	200	45
163220	220	45
163240	240	45
163260	260	45
163280	280	45
163300	300	45

**Ohne Borde**

**Without folded rim**



#	Ø mm	↑ mm
164120	120	60
164140	140	60
164160	160	60
164180	180	60
164200	200	60
164220	220	60
164240	240	60
164260	260	60
164280	280	60
164300	300	60

DE	DESSERT- UND TORTENRINGE
EN	DESSERT AND TART RINGS
IT	ANELLI PER DOLCI E TORTE
ES	AROS PARA POSTRES Y TARTAS

Material: Aluminium

- Nahtgeschweißt

Made of aluminium

- Welded seam

#	Ø mm	↑ mm	∓ mm	
156753	75	30	1,0	
156754	75	40	1,5	
156077	80	20	1,0	
156083	80	40	2,0	
156853	85	30	1,0	
156078	90	20	1,0	
156953	95	30	1,0	
156079	100	20	1,0	
156161	150	45	2,0	
156165	160	50	2,0	
156166	160	60	2,0	
156185	180	50	2,0	
156186	180	60	2,0	
156187	180	70	2,0	
156205	200	50	2,0	
156206	200	60	2,0	
156207	200	70	2,0	
156208	200	80	2,0	
156225	220	50	2,0	
156226	220	60	2,0	
156227	220	70	2,0	
156245	240	50	2,0	
156246	240	60	2,0	
156247	240	70	2,0	
156265	260	50	2,0	
156266	260	60	2,0	
156267	260	70	2,0	
156268	260	80	2,0	
156284	280	40	2,0	
156285	280	50	2,0	
156286	280	60	2,0	
156287	280	70	2,0	
156288	280	80	2,0	
156327	320	70	2,0	
156387	380	70	2,0	
156465	460	50	3,0	



6

DE	FLORENTINERRING / DESSERTRINGE
EN	DESSERT RINGS
IT	ANELLI PER DOLCI
ES	AROS PARA POSTRES

Material: Schwarzblech

- Verschweißte Naht

Made of black steel

- Welded seam

#	Ø mm	↑ mm	∓ mm	
164400	80	20	1,0	
164401	90	20	1,0	
164402	100	20	1,0	





DE	TORTENRING-SET
EN	SET OF TART RINGS FOR CAKE STANDS
IT	SET DI ANELLI PER TORTE
ES	JUEGO DE AROS PARA TARTAS

Aus Aluminium

- Nahtgeschweißt
- Materialstärke 2 mm
- Für 3-, 4-, 5- und 7-teilig Tortenständer

Made of aluminium

- Welded seam
- Thickness: 2 mm
- For cake stands with 3 / 4 / 5 / 7 floors

#	↑ mm	Ø mm	
156013	60	190 / 250 / 310	3-teilig / 3 pieces
156014	60	190 / 250 / 310 / 390	4-teilig / 4 pieces
156015	60	190 / 250 / 310 / 390 / 440	5-teilig / 5 pieces
156017	60	150 / 190 / 250 / 310 / 390 / 440 / 490	7-teilig / 7 pieces



DE	TORTENBLECH
EN	FLAN CASE
IT	BASE PER TORTA
ES	BASE DE LA TARTA

Material: Aluminium

Made of aluminium

#	Ø mm	↑ mm	
156980	265	8	
156981	285	8	



DE	TORTENSCHIEBEN
EN	CAKE PLATES
IT	DISCHI PER TORTE
ES	DISCOS PARA TARTAS

Material: Aluminium

- Mit Aufhängeloch

Made of aluminium

- With hanging hole

#	Ø mm	↑ mm	
156241	240	1,0	
156261	260	1,0	
156281	280	1,0	
156282	280	1,5	
156301	300	1,0	
156302	300	1,5	
156321	320	1,0	
156322	320	1,5	



DE	TORTENSCHIEBENSTÄNDER
EN	SUPPORT FOR CAKE PLATES
IT	SUPPORTO PER DISCHI PER TORTE
ES	SOPORTE PARA DISCOS DE TARTAS

- Weiße Kunststoffbeschichtung
- 2 seitliche Griffe

- White plastic coating
- Handles on both sides

#	↔ mm	
157010	500 x 200 x 180	

DE	TORTENRING / STOLLENRING
EN	TART RINGS
IT	ANELLI PER TORTE
ES	AROS PARA TARTAS

- Material: Aluminium
- Nahtgeschweißt
  - Materialstärke: 2,0 mm

- Made of aluminium
- Welded seam
  - Thickness: 2.0 mm

**Ovale Form – für Quarkstollen**

**Oval**

#	↗ mm	→ mm	↑ mm
155050	235	105	40
155051	180	105	50



**Herz**

**Heart**

#	∅ mm	↑ mm
155070	160	50
155071	180	50
155072	200	50
155073	220	50
155074	240	50

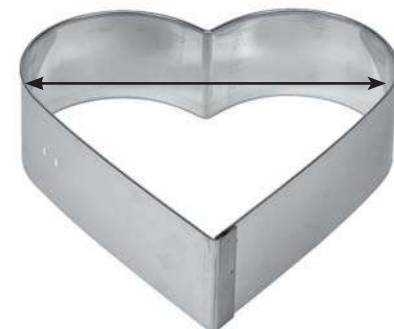

DE	BACKRAHMEN "HERZ"
EN	BAKING FRAMES "HEART"
IT	TELAJ PER TORTE, "CUORE", REGOLABILE
ES	AROS PARA TARTAS, CORAZÓN AJUSTABLE

- Material: Edelstahl
- Materialstärke: 0,5 – 1,0 mm
  - Ausziehbar / verstellbar

- Made of stainless steel
- Thickness: 0.5 – 1.0 mm
  - Extensible

#	↔ mm	↑ mm
199160	220 – 270	70
199161	290 – 380	70
199162	430 – 500	70



DE	TORTENRINGE RUND, VERSTELLBAR
EN	CAKE RINGS ROUND, ADJUSTABLE
IT	ANELLI PER TORTE ROTONDI, REGOLABILI
ES	AROS PARA TARTAS, AJUSTABLE

- Material: Edelstahl
- Materialstärke: 1,2 mm

- Made of stainless steel
- Thickness: 1.2 mm

#	↔ mm / mind.	↔ mm / max.	↑ mm
199986	180	300	50
199987	180	300	60
199988	300	500	60



DE	TORTENRING – HALBKREIS
EN	TART RING – SEMI-CIRCLE
IT	ANELLO PER TORTE – SEMICERCHIO
ES	ARO PARA TARTAS – SEMICÍRCULO

- Material: Edelstahl

- Made of stainless steel

#	↗ mm	→ mm	↑ mm
164900	300	150	45



6

Passende Tortenplatte auf Seite 188. / Matching cake plate on page 188.

DE	DESSERT- / TORTENRINGE
EN	DESSERT / TART RINGS
IT	ANELLI PER TORTE E DESSERT
ES	AROS PARA TARTAS

Material: Edelstahl

Made of stainless steel

#		↔ mm	↑ mm
155060	Achteck / octagon	Ø: 160	50
155100	Sechseck / hexagon	Ø: 160	50
155110	Sechseck / hexagon	Ø: 180	50
155120	Sechseck / hexagon	Ø: 200	50
155200	Herz / heart	Ø: 180	50
155210	Herz / heart	Ø: 200	50
155220	Herz / heart	Ø: 230	50
155300	Dreieck / triangle	L: 160	50
155310	Dreieck / triangle	L: 180	50
155320	Dreieck / triangle	L: 200	50

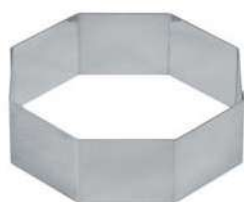

# 155060



# 155100 – 155120



# 155200 – 155220



# 155300 – 155320

#		↗ mm	↑ mm	⊥ mm
155330	Tropfen / tear-drop	160	50	1,2
155331	Tropfen / tear-drop	180	50	1,2
155332	Tropfen / tear-drop	200	50	1,2
155340	Dreieck, gewölbt / triangle, convex	160	50	1,2
155341	Dreieck, gewölbt / triangle, convex	180	50	1,2
155342	Dreieck, gewölbt / triangle, convex	200	50	1,2
155350	Viereck, gewölbt / square, convex	140	50	1,0
155351	Viereck, gewölbt / square, convex	160	50	1,0
155352	Viereck, gewölbt / square, convex	180	50	1,0



# 155330 – 155332



# 155340 – 155342



# 155350 – 155352

DE	SCHNITTEN-/BACKRAHMEN QUADRAT / RECHTECKIG
EN	TART RINGS SQUARE / RECTANGULAR
IT	TELAJ PER TORTE, QUADRATI / RETTANGOLARI
ES	AROS PARA TARTAS, CUADRADOS / RECTÁNGULARES

Material: Edelstahl

Made of stainless steel

• Materialstärke: 1,5 mm

• Thickness: 1.5 mm

#	↗ mm	→ mm	↑ mm
155361	100	100	50
155363	120	120	50
155365	140	140	50
155367	160	160	50
155369	180	180	50
155371	200	200	50
155373	220	220	50
155375	240	240	50
155377	260	260	50
155379	280	280	50
155357	300	300	50
155380	140	240	40
155381	140	240	50
155382	160	260	40
155383	160	260	50
155384	180	280	40
155385	180	280	50
155386	220	300	40
155387	220	300	50
155388	260	380	40
155389	260	380	50
155390	300	400	40
155391	300	400	50
155399	380	580	50



6

DE	BACKRAHMEN RECHTECKIG, VERSTELLBAR
EN	CAKE RINGS, RECTANGULAR, ADJUSTABLE
IT	TELAJ PER TORTE, RETTANGOLARI, REGOLABILI
ES	AROS PARA TARTAS, RECTÁNGULARES, AJUSTABLES

Material: Edelstahl

Made of stainless steel

• Materialstärke: 1,2 mm

• Thickness: 1.2 mm

#	↔ mm	↔ mm (max.)	↑ mm
155400	215 x 115	405 x 200	80
155410	430 x 290	840 x 560	50
155420	300 x 300	570 x 560	50
155430	216 x 310	405 x 605	50

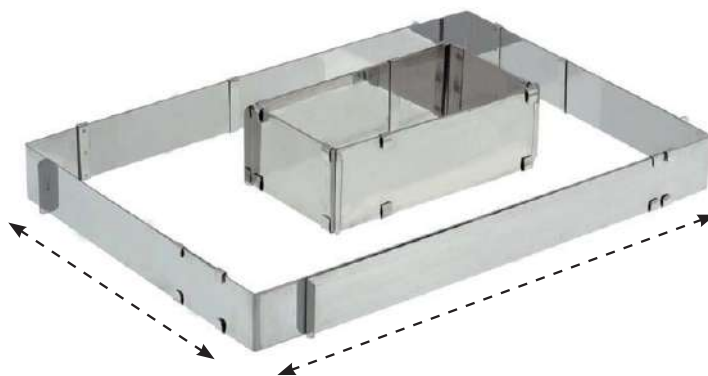

DE	DESSERTRING
EN	DESSERT RING
IT	ANELLO PER DOLCI
ES	ARO PARA POSTRES

NICHT zum Backen geeignet!  
NOT for baking!



**Material: PS, elfenbein**

**Made of PS, ivory**

#	Ø mm	↑ mm
200950	75	30



**Material: Reinaluminium**

**Made of pure aluminium**

- Nahtgeschweißt
- Extra stark

- Welded seam
- Extra strong

#	Ø mm	↑ mm	⊥ mm
156075	75	30	2,0
156076	75	40	2,0

**“MINI”**

Material: Edelstahl

- Materialstärke: 0,8 mm

**“MINI”**

Made of stainless steel

- Thickness: 0.8 mm

#		↔ mm	↑ mm
155450	Rund / round	Ø 70	45
155451	Oval / oval	L: 74 x B: 56	45
155452	Tropfen / drop	L: 77 x B: 54	45
155453	Dreieck / triangle	B: 68	45
155454	Herz / heart	H: 55 x B: 67	45
155455	Sechseck / hexagon	B: 54	45
155456	Quadrat / square	B: 54	45

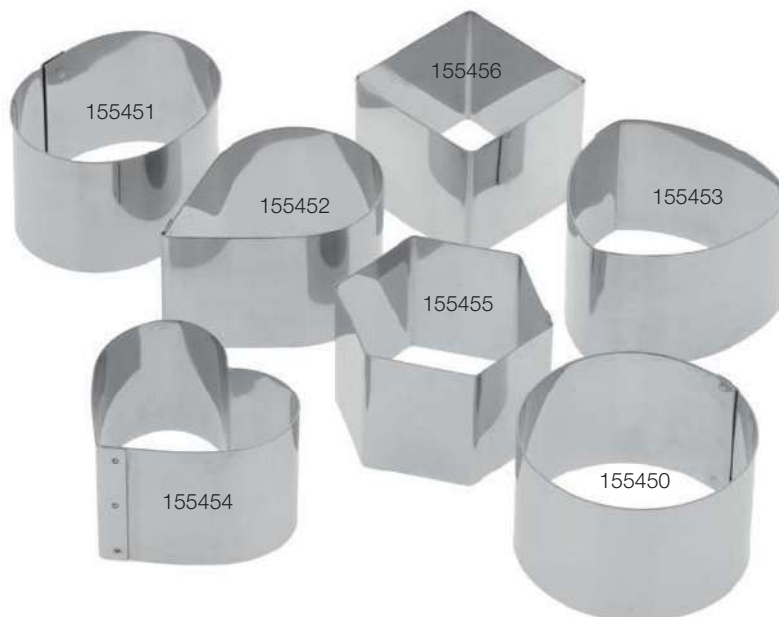



DE	TORTENGITTERSTANZE
EN	LATTICE MATRIX
IT	GRIGLIA PER CROSTATE
ES	REJILLA CORTANTE PARA PASTA FROLA

Material: PS, weiß

- Bestehend aus 2 Teilen
- Für Linzer Torten, Holländer Gebäck usw.

Made of PS, white

- 2 parts
- For "Linzer" cakes, Dutch pastries etc.

#	Ø
158006	300

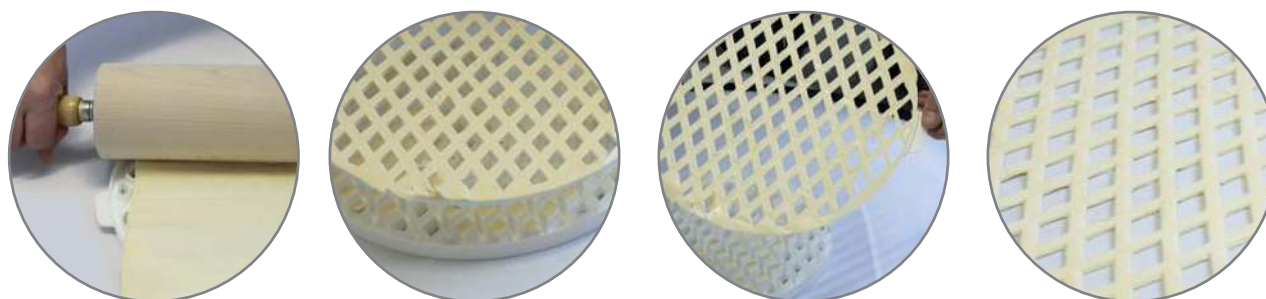

6

DE	TORTENBODENSÄGE
EN	TART / CAKE SAW
IT	LIRA PER PAN DI SPAGNA
ES	CORTADOR DE PASTELES

Material: Edelstahl

- Mit drei Sägeblättern
- Sägeblätter in der Höhe verstellbar

Made of stainless steel

- With three saw blades
- Saw blades adjustable in height

#	→ mm	⏏ mm	↑ mm
153500	460	430	235
153510	Ersatzblatt / Spare saw blade		



Material: Rahmen aus lackiertem Stahl

- 2 Sägeblätter aus Edelstahl
- Sägeblätter in der Höhe verstellbar

Frame made of lacquered steel

- 2 saw blades made of stainless steel
- Saw blades adjustable in height

#	→ mm	⏏ mm	↑ mm
153550	460	430	160
153351	Ersatzblatt / Spare saw blade		
153560	595	570	165
153352	Ersatzblatt / Spare saw blade		





DE	TORTENEINTEILER
EN	TART MARKERS
IT	SEGNAPORZIONI PER TORTE
ES	MARCADOR DE PASTELES

**EINSEITIG**

**Material: Edelstahl**

- Sehr stabile Ausführung

**ONE-SIDED**

**Made of stainless steel**

- Very strong quality



#	Teilungen / Pieces	Ø mm	↑ mm
120108	8	330	28
120110	10	330	28
120112	12	330	28
120114	14	330	28
120116	16	330	28
120118	18	330	28

**DOPPELSEITIG**

**Material: Edelstahl**

- Sehr stabile Ausführung
- Mit 2 Griffen

**DOUBLE-SIDED**

**Made of stainless steel**

- Very strong quality
- With 2 handles



#	Teilungen / Pieces	Ø mm	↑ mm
120190	8/12	330	53
120191	10/12	330	53
120192	10/14	330	53
120193	10/16	330	53
120194	12/14	330	53
120195	12/16	330	53

**EINSEITIG**

**Material: PP, elfenbein**

- Mit 2 Griffen

**ONE-SIDED**

**Made of PP, ivory**

- With 2 handles



#	Teilungen / Pieces	Ø mm
220108	8	265
220110	10	265
220112	12	265
220114	14	265
220116	16	265
220118	18	265
220119	20	265

**DOPPELSEITIG**

**Material: PP, elfenbein**

- Mit 2 Griffen

**DOUBLE-SIDED**

**Made of PP, ivory**

- With 2 handles



#	Teilungen / Pieces	Ø mm
220128	8/12	265
220120	12/16	265
220122	14/16	265
220124	12/18	265
220126	14/18	265

DE	SCHNITTENRAHMEN
EN	FRAME
IT	TELAIO DA TAGLIO
ES	MARCO PARA PORCIONES

Material: Aluminium

- Variabel verstellbarer Rahmen
- Teiler entnehmbar / versetzbar
- Doppelseitig verwendbar
- Für 28 Schnitten 60 x 60 mm oder 33 Schnitten 80 x 40 mm
- Für 70 Schnitten 80 x 40 mm oder 54 Schnitten 65 x 65 mm

Made of aluminium

- Variable adjustable frame
- Divider removable / relocatable
- Two-sided use
- For 28 pieces 60 x 60 mm or 33 pieces 80 x 40 mm
- For 70 pieces 80 x 40 mm or 54 pieces 65 x 65 mm

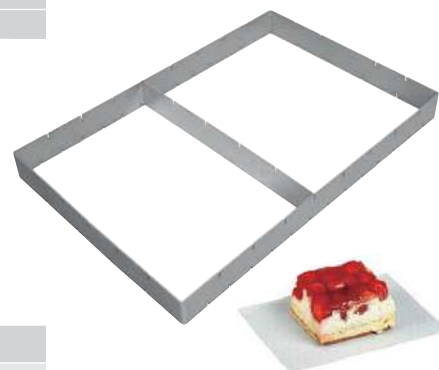

#	↗ mm	→ mm	↑ mm	
199590	440	240	50	
199591	560	370	50	

DE	BACKLINEALE
EN	DOUGH RULERS
IT	RIGHELLI PER PASTICCERIA
ES	REGLAS GRADUADAS PARA PASTELERÍA

Material: Polystyrol, flexibel, weiß

- Mit Aufhängeöse
- 7 Einteilungen 8 cm
- Und 5 Einteilungen 12 cm

Made of polystyrene, flexible, white

- With suspension eye
- 7 divisions of 8 cm each
- And 5 divisions of 12 cm each

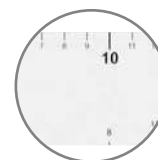

#	↗ mm	→ mm	↑ mm	
<input checked="" type="checkbox"/> 200900	640	50	2	

- 13 Einteilungen 8 cm
- 8 Einteilungen 12 cm

- 13 divisions of 8 cm each
- And 8 divisions of 12 cm each

#	↗ mm	→ mm	↑ mm	
<input checked="" type="checkbox"/> 200915	980	50	2	

Material: Resopal, stabil, weiß

- Mit Aufhängeöse
- 7 Einteilungen 8 cm
- 5 Einteilungen 12 cm

Made of Formica, solid, white

- With suspension eye
- 7 divisions of 8 cm each
- And 5 divisions of 12 cm each

#	↗ mm	→ mm	↑ mm	
<input checked="" type="checkbox"/> 200899	645	50	2	



DE	TORTENGITTER
EN	GRATES
IT	GRIGLIE
ES	REJILLAS

Material: Edelstahl

Made of stainless steel

#		Ø mm
156115	"Karo" mit Füßen / "square" pattern, with feet	320
156116	"Karo" mit Füßen / "square" pattern, with feet	360
156128	"Spirale" ohne Füße / "spiral" pattern, without feet	320
156129	"Spirale" ohne Füße / "spiral" pattern, without feet	360
156130	"Spirale" mit Füßen / "spiral" pattern, with feet	320
156131	"Spirale" mit Füßen / "spiral" pattern, with feet	360



# 156115 + 156116

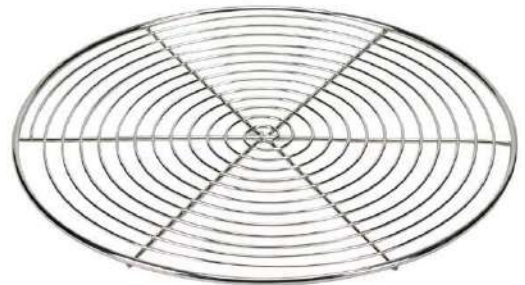

# 156128 + 156129



# 156130 + 156131

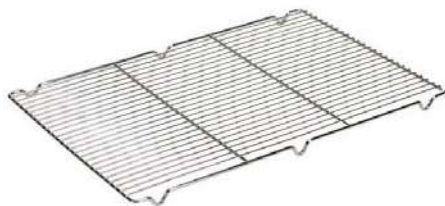

Material: Edelstahl

- Extra stabile Ausführung
- Mit 3 Traversen
- Mit Füßen

Made of stainless steel

- Very strong quality
- With 3 traverses
- With feet

#	↗ mm	→ mm
156124	590	390



© stock.adobe.com

DE	PRALINEN- / TRÜFFELGITTER
EN	CHOCOLATE / TRUFFLE GRATES
IT	GRIGLIE PER CIOCCOLATINI E TARTUFFI
ES	REJILLAS PARA PRALINÉS Y TRUFAS

Material: Edelstahl

- Design: „Karo“
- Mit Füßen
- Höhe: 28 mm

Made of stainless steel

- Design: “square” pattern
- With feet
- Height: 28 mm



#	↗ mm	→ mm	⊞ mm	⊥ mm
156125	440	315	10 x 10	1
156126	580	390	10 x 10	1

DE	GRILLROSTE
EN	GRIDS
IT	GRIGLIE
ES	REJILLAS

Material: Edelstahl

Made of stainless steel

#		↗ mm	→ mm	≡	∅ mm	Drähte ∅ mm / wire ∅ mm
156110		600	400	2	6	24 / 3
156111	<b>GN 1/1</b>	530	325	1	7	20 / 3
156112	<b>GN 2/3</b>	354	325	1	5	15 / 2
156113	<b>GN 2/1</b>	650	530	3	6	32 / 2

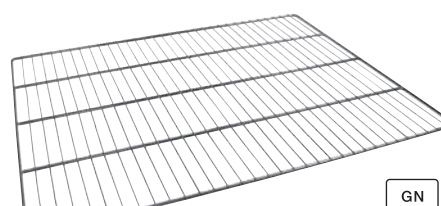
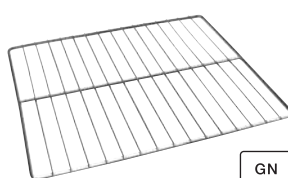
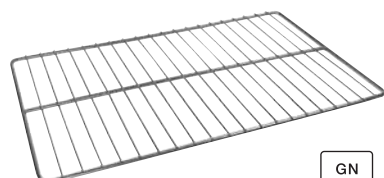
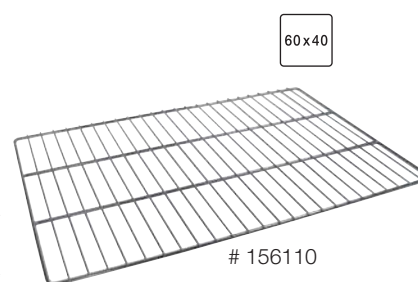



DE	SCHILLERLOCKENFORMEN / HÖRNCHENBACKFORM – GERADE
EN	CREAM HORN MOULDS STRAIGHT
IT	CONI PIATTI PER CANNONCINI
ES	MOLDES PARA CONOS, PLANOS

Material: Edelstahl

Made of stainless steel

#	↗ mm	Ø mm	
198012	90	25	
198008	120	30	
198009	140	35	
198010	160	40	



DE	SCHILLERLOCKENFORMEN SCHRÄG
EN	CREAM HORN MOULDS OBLIQUE
IT	CONI OBLIQUI PER CANNONCINI
ES	MOLDES PARA CONOS, OBLICUOS

Material: Edelstahl

Made of stainless steel

#	↗ mm	Ø mm	
198013	120	30	
198014	140	35	
198015	160	40	



DE	CANNOLI
EN	CANNOLI
IT	STAMPI PER CANNOLI
ES	MOLDES PARA CANNOLI

Material: Edelstahl

Made of stainless steel

#	↗ mm	Ø mm	
198017	125	35	



DE	RAHM- UND CREMEROLLEN / CANNOLI BACKFORM
EN	CREAM ROLL MOULDS
IT	STAMPI PER CANNONCINI
ES	MOLDES PARA CANUTILLOS

Material: Edelstahl

Made of stainless steel

#	↗ mm	Ø mm	
198000	200	9	
198001	200	11	
198002	200	12,5	
198003	200	14	
198004	200	16	
198005	200	18	
198006	140	22	
198007	140	27	

DE	MARZIPAN-MODELLIERSET
EN	MARZIPAN MODELLING SET
IT	KIT PER MARZAPANE (15 PZ.)
ES	JUEGO DE UTENSILIOS PARA MAZAPÁN (15 UNIDADES)

Material: PP

- Das Set bestehend aus:  
2 Strukturbrettern, 1 Marzipanmesser,  
12 verschiedene Modellierstäbe

Made of PP

- Set consisting of 2 boards, 1 knife and  
12 modelling tools



#		
227200	Set 15-teilig / set 15 pieces	

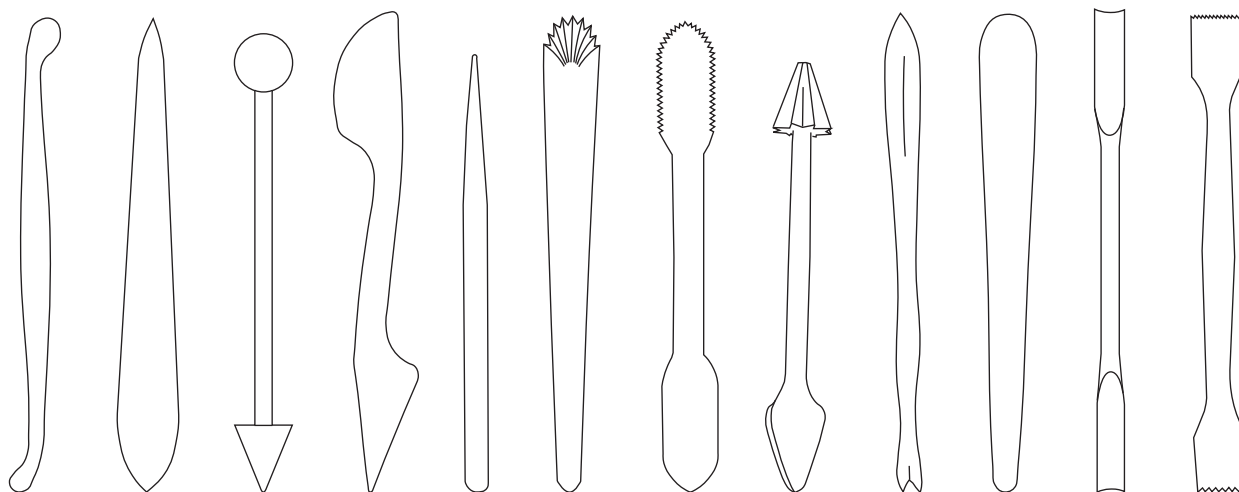

6

DE	GLÄTTER FÜR FONDANT
EN	CAKE POLISHER FOR SUGAR PASTE
IT	STENDIPASTA PER PASTA DI ZUCCHERO
ES	ESPATÚLA PARA FONDANT (PASTA DE AZÚCAR)

Material: Kunststoff, weiß

Made of plastic, white

#		↔ mm
166130		160 x 80



DE	MODELLIERSET
EN	MODELLING SET
IT	KIT DI UTENSILI PER MODELLARE (8 PZ.)
ES	JUEGO DE UTENSILIOS PARA MODELAR (8 UNIDADES)

Material: Kunststoff

- Farbe: rot / weiß

Made of plastic

- Color: red / white



#		↗ mm
166140		165
	Set 8-teilig / set 8 pieces	



# 181014

DE	WASSER-SPRÜHPISTOLE / GEBÄCKSPRÜHER
EN	WATER SPRAY GUN
IT	PISTOLA VAPORIZZATRICE
ES	PISTOLA VAPORIZADORA

Griff: PA, schwarz  
 Schlauch ausziehbar bis 300 – 400 cm,  
 Anschlüsse Edelstahl, Messing, vernickelt

- Teiglinge, Brote und Brötchen können waagrecht und nebfrei besprüht werden
- Raum- und zeitsparend
- Hygienisch, ersetzt Brotstreicher

Handle: PA, black  
 extensible hose up to 300 – 400 cm,  
 connections Made of stainless steel, brass, nickel-plated

- For spraying steam on dough and bread
- Usable horizontally
- Space and time saving, hygienic

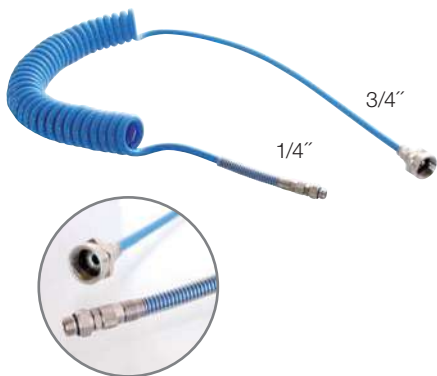

1/4"

3/4"



# 181100



# 181160



# 181170

#		l (cm)
181014	Wasser-Sprühpistole gerade / spray gun, straight sprayer pipe	22
181100	Wasser-Sprühpistole 30° abgewinkelt / spray gun, angular sprayer pipe 30°	22
181160	Wasser-Sprühpistole 30° abgewinkelt / spray gun, angular sprayer pipe 30°	60
181170	Wasser-Sprühpistole 30° abgewinkelt / spray gun, angular sprayer pipe 30°	100
181200	Schlauch – blau / hose – blue	

DE	WASSER-SPRÜHPISTOLE / GEBÄCKSPRÜHER	
EN	WATER SPRAY GUN	
IT	PISTOLA VAPORIZZATRICE	
ES	PISTOLA VAPORIZADORA	



# 182005

Griff: PA, schwarz  
 Schlauch ausziehbar bis 300 – 400 cm,  
 alle Bauteile aus Edelstahl

- Teiglinge, Brote und Brötchen können waagrecht und nebfrei besprüht werden
- Raum- und zeitsparend
- Hygienisch, ersetzt Brotstreicher
- **100% Lebensmittelecht**

Handle: PA, black  
 extensible hose up to 300 – 400 cm,  
 all components Made of stainless steel

- For spraying steam on dough and bread
- Usable horizontally
- Space and time saving, hygienic
- **100% food safe**



# 182000

#	
182005	Wasser-Sprühpistole gerade – Standard Düse 35 – 40 Liter / spray gun, straight sprayer pipe – Nozzle 35 – 40 l
182000	Wasser-Sprühpistole 30° abgewinkelt – Standard Düse 35 – 40 Liter / spray gun, angular sprayer pipe 30° – Nozzle 35 – 40 l
182010	Schlauch – schwarz / hose – black
182020	Ersatzteil-Set / Spare parts set
182030	Reduzierstück / adapter
182040	Ersatzdüse inkl. Dichtungsring – Fördermenge ca. 35 bis 40 l/h / Spare nozzle incl. sealing ring – flow rate approx 35 to 40 l/h
182045	Ersatzdüse inkl. Dichtungsring – Fördermenge ca. 6 bis 8 l/h / Spare nozzle incl. sealing ring – flow rate approx 6 to 8 l/h



# 182010



# 182020



# 182030



# 182040



# 182045



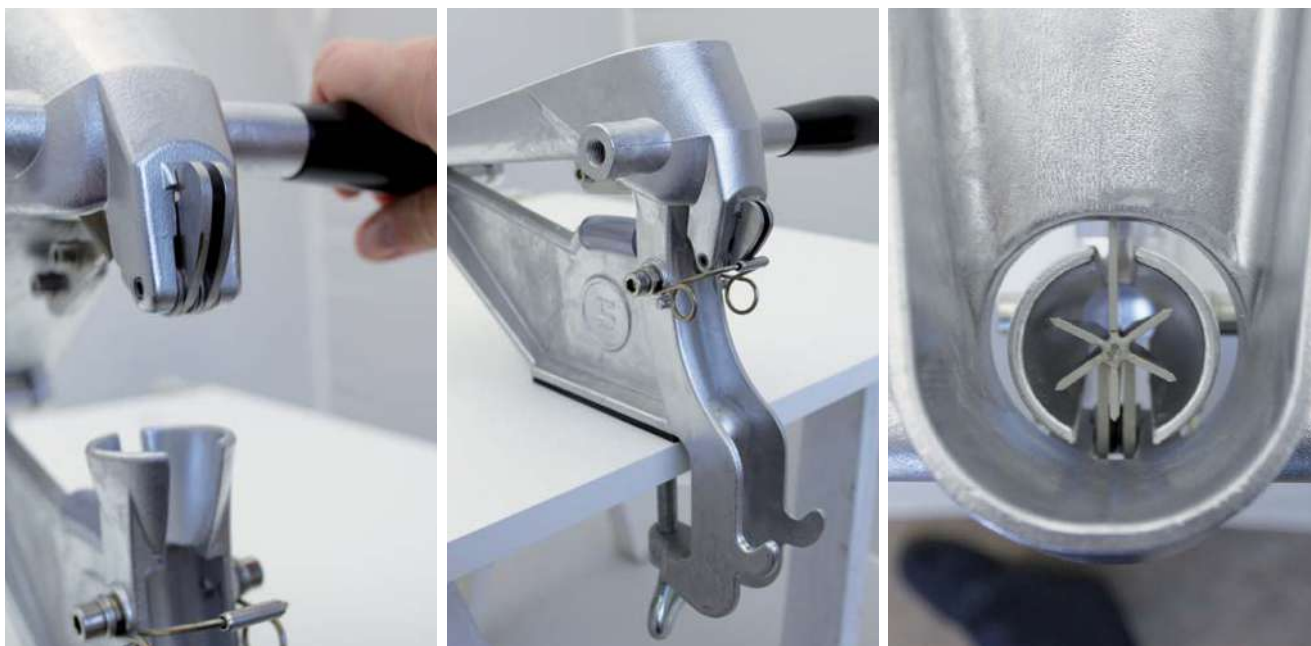

6

DE	HANDENTSTEINER
EN	PLUM STONING DEVICE
IT	SNOCCIOLATORE PER PRUGNE
ES	DESCORAZONADOR DE CIRUELAS

Material: Aluminiumguss

- Für Pflaumen und Zwetschgen
- Mit Rechts- und Linkshandgriff
- Obstsäurebeständiges Messer

Made of cast aluminium

- For plums
- Usable for right and left-handed users
- With stone outlet and fruit ejector
- Acid resistant knife

#		
151300	Handentsteiner inkl. 6-teiliges Messer mit Auswerfer	
151301	Ersatzmesser 6-teilig/replacement knife (6 pcs.)	



DE	APFELSCHÄLMASCHINE
EN	APPLE PEELING MACHINE
IT	PELA E AFFETTA MELE
ES	PELADORA DE MANZANAS

Gehäuse aus Aluminiumguß, weiß lackiert

- Alle Metallteile aus rostfreiem Stahl
- Für Bäckereien, Konditoreien, Küchen, gewerbliche Zwecke
- Maschine schält den frischen Apfel innerhalb von 15 Sekunden und sticht das Kernhaus aus

Housing made of cast aluminium, white

- All metal parts made of stainless steel
- For bakeries, confectioneries, kitchens, commercial use
- Machine peels the fresh apple within 15 seconds and removes the the core out

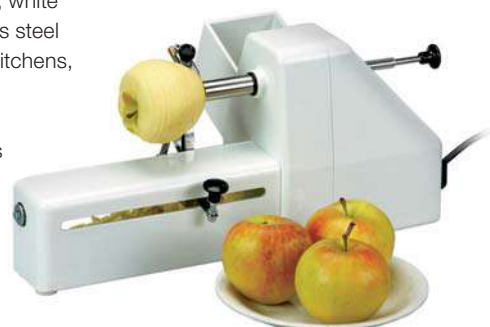

#				
150000	60 W	220 V	130 x 410 x 195	5,6 kg



DE	THERMOMETER / EINSTICHTHERMOMETER
EN	THERMOMETER
IT	TERMOMETRO
ES	TERMÓMETRO



- Temperaturfühler 1,5 mm dünn
  - Fühlt die Temperatur im Produkt und nicht in der Umgebung
  - Reaktionszeit ca. 2–4 Sekunden
  - Genauigkeit: 0,1°C
  - 80 cm Kabel
  - Gehäuse mit eingebautem Magnet – haftet an allen ferromagnetischen Oberflächen
  - Kostenlose APP (IOS- und Android Gerät) via Bluetooth mit dem Thermometer verknüpfbar
  - Für professionelle Wareneingangskontrolle
  - Datum, Uhrzeit und eigenen Notizen können mit dem zugeordneten Foto gespeichert und versendet werden
  - 2 x AA Batterien
- Temperature sensor 1.5 mm thin
  - The temperature is measured inside the product and not in the environment
  - Reaction time approx. 2–4 seconds
  - Accuracy: 0.1 °C
  - Cable length 80 cm
  - Housing with built-in magnet – adheres to all ferromagnetic surfaces
  - Free app (IOS and Android device) can be connected via Bluetooth with the thermometer
  - For professional incoming goods inspection
  - Date, time and own notes can be saved and sent with the assigned photo
  - 2 x AA batteries

#	°C
160050	- 200 / + 400

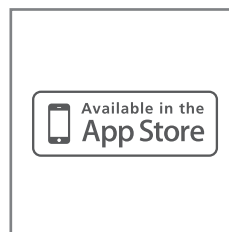

DE	INFRAROT-THERMOMETER
EN	INFRARED THERMOMETERS
IT	TERMOMETRI
ES	TERMÓMETROS

Für berührungsloses Messen der Oberflächentemperatur.

For non-contact measuring of surface temperature.

- Großes beleuchtetes Display
- Messdauer 0,5 Sekunden
- Mit Laservisier
- Inklusive Batterie

- Large backlight display
- Measuring time 0.5 seconds
- With laser-sighting
- Battery included



# 160014

#	°C	↔ mm
160014	-35 / + 365	166 x 34 x 64

- Beleuchtetes Display,
- Messdauer 1,0 Sekunden
- Inklusive Batterie und Tasche

- Backlight display
- Measuring time 1.0 seconds,
- Battery and bag included



# 160019

#	°C	↔ mm
160019	-33 / + 500	175 x 39 x 79

- Großes beleuchtetes Display
- Messdauer 0,8 Sekunden
- Mit Laservisier
- Exklusive Batterie

- Large backlight display
- Measuring time 0.8 seconds
- With laser-sighting
- Battery not included



#	°C	↔ mm
<input checked="" type="checkbox"/> 160100	-50 / + 400	150 x 40 x 105

Infrarot-Thermometer mit Einsteckfühler

Infrared thermometer with plug-in sensor

- Zum Messen der Oberflächen- und Kerntemperatur
- Max.-Min.-Funktion
- Messbereich Einsteckfühler -40°C / +280°C
- Genauigkeit +/- 2°C im Bereich -40°C / +20°C, +/-1°C im Bereich +20°C / +100°C, sonst +/-1%, Auflösung 0,1°C, D:S = 4:1
- Inklusive Batterie

- For measuring the surface and core temperature
- Max.-min. function
- Measuring range penetration probe -40°C/+280°C
- Accuracy +/- 2°C in the range -40°C / +20°C, +/-1°C in the range +20°C / +100°C, otherwise +/-1%, resolution 0.1°C, D:S = 4:1
- Battery included



#	°C	↔ mm
<input checked="" type="checkbox"/> 160051	-40 / + 280	140 x 380 x 24



DE	THERMOMETER
EN	THERMOMETERS
IT	TERMOMETRI
ES	TERMÓMETROS

Material: Edelstahl / Made of stainless steel

#	°C	für / for	
<input checked="" type="checkbox"/> 160005	0 / +350	Fleisch / meat	

Verchromter Draht / Chromed wires

#	°C	für / for	↗ mm	
160001	-10 / +110	Milch / milk	300	
160002	+80 / +180	Zucker / sugar	300	
160003	+80 / +220	Fett / fat	300	

**i** Füllstoff: gefärbter Weingeist. / Filling material: colored alcohol.

- Mit Klipp / • Pen thermometers

#	°C	↗ mm	
160004	-20 / +50	140	

**i** Füllstoff: gefärbter Weingeist. / Filling material: colored alcohol.

- Glaseinsatz / • Glass insert
- Gehäuse aus Kunststoff / • Plastic housing

#	°C	für / for	↗ mm	
160012	0 / +110	Milch / milk	280	

**i** Füllstoff: eingefärbtes Petroleum. / Filling material: colored petroleum.



DE	STIELSCHABER MIT THERMOMETER
EN	SPATULA WITH THERMOMETER
IT	SPATOLE CON TERMOMETRO
ES	ESPÁTULA CON TERMOMETRO

- Hitzebeständiges Silikon / • Heat-resistant silicone
- Auflösung: 0,1 °C / • Resolution: 0.1 °C
- Genauigkeit: +/- 1 °C (0 °C / + 100 °C), sonst +/- 1 % / • Accuracy: +/- 1 °C (0 °C / + 100 °C), otherwise +/- 1 %
- Fühlerlänge: 235 mm / • Probe length: 235 mm
- Inklusive Batterie / • Battery included

#	°C	↔ mm	
<input checked="" type="checkbox"/> 160015	-50 / +300	320 x 65	



DE	THERMOMETER
EN	THERMOMETERS
IT	TERMOMETRI
ES	TERMÓMETROS



Kühlthermometer

- Kunststoffgehäuse, mit Halter und Befestigungsmaterial
- Abweichung +/- 0,5 °C

Freezer / fridge thermometer

- Plastic housing, support and fixing material
- Difference +/- 0,5 °C

#	°C	↗ mm
160028	- 30 / +20	265

**i** Füllstoff: gefärbter Weingeist. / Filling material: colored alcohol.  
 Werkprüfschein liegt vor. / Manufacturer test certificate available.

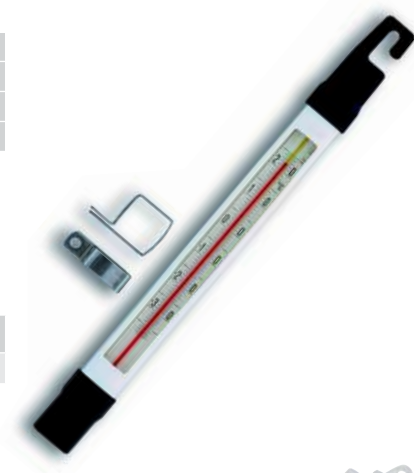

Kühlthermometer

- Kunststoffgehäuse
- Drehbar

Freezer / fridge thermometer

- Plastic housing
- Rotating

#	°C	↗ mm
160026	- 50 / +50	215 mm

**i** Füllstoff: gefärbter Weingeist. / Filling material: colored alcohol.



Kühlthermometer

- Kunststoffgehäuse mit Halter

Freezer / fridge thermometer

- Plastic housing and support

#	°C	↗ mm / Ø mm
160034	- 46 / +30	215
160035	- 30 / +50	Ø: 52
160036	- 50 / +50	Ø: 70

# 160035

# 160034



# 160036

DE	REFRAKTOMETER
EN	REFRACTOMETER
IT	RIFRATTOMETRO
ES	REFRACTÓMETRO

Hand-Refraktometer zur Messung des Brix-Wertes von Zucker, Glasur, Sorbets, Konfitüren, Eis und Gelees.

- Automatisches temperaturkompensiertes Messergebnis
- Spritzwassergeschützt
- Inkl. Aufbewahrungsbox

Hand-held refractometer for measuring the Brix value of sugar, icing, sorbets, jams, ice cream and jellies.

- Automatic temperature compensation
- Splash proof
- Including storage box

#	
161020	0 – 50 % Brix
161030	0 – 90 % Brix



DE	DIGITALER EINSTICHTHERMOMETER
EN	DIGITAL PROBE THERMOMETER
IT	TERMOMETRO CON SONDA
ES	TERMÓMETRO CON SONDA

Für Temperaturmessungen in Flüssigkeiten, pulvrigen und plastischen Stoffen.

For temperature measurements of liquid, powdered and plastic materials.

- Mit extralangem Fühler (125 mm)
- Wasserdicht
- Umschaltbar °C/°F
- Inklusive Schutzhülse und Batterie

- With extra long probe, (125 mm)
- Waterproof
- Switchable °C/°F
- Including protection case and battery

#	°C	
<input checked="" type="checkbox"/> 160006	- 40 / + 200	



- Temperaturmessung gemäß HACCP
- Messung berührungslos mit Einstichfühler
- Wasserdicht
- Inklusive Batterie

- Temperature measurement according to HACCP
- Non-contact measurement with insertion probe
- Waterproof
- Battery included

#	°C	↔ mm
160029	- 40 / + 250	60



- Hold / Test-Funktion
- Genauigkeit +/-1°C
- Auflösung 0,1°C
- Fühlerlänge: 140 mm
- Inklusive Batterie

- Hold / Test Function,
- Accuracy +/-1°C
- Resolution: 0.1°C
- Probe length: 140 mm
- Battery included

#	°C	↔ mm
<input checked="" type="checkbox"/> 160052	- 50 / + 300	240



DE	DIGITALER EINSTICHTHERMOMETER
EN	DIGITAL PROBE THERMOMETER
IT	TERMOMETRO CON SONDA
ES	TERMÓMETRO CON Sonda

- |  |  |
|--|--|
| <ul style="list-style-type: none"> <li>• Hold / Test-Funktion</li> <li>• Temperaturalarm</li> <li>• Max.-Min.-Funktion</li> <li>• Genauigkeit +/-1°C</li> <li>• Auflösung 0,1°C</li> <li>• Fühlerlänge: 100 mm,</li> <li>• Kabellänge: ca.1 Meter</li> <li>• Inkl. Batterie</li> </ul> | <ul style="list-style-type: none"> <li>• Hold / Test Function</li> <li>• Temperature alarm</li> <li>• Max. min. function</li> <li>• Accuracy +/-1°C</li> <li>• Resolution: 0.1°C</li> <li>• Probe length: 100 mm,</li> <li>• Cable length: approx. 1 meter</li> <li>• Incl. battery</li> </ul> |
|--|--|

#	°C	↔ mm
<input checked="" type="checkbox"/> 160056	-50 / +300	120 x 60



- |   |  |
|---|--|
| <ul style="list-style-type: none"> <li>• Temperaturalarm, Timer</li> <li>• Standgerät und mit Magnet</li> <li>• Fühlerlänge: 140 mm,</li> <li>• Kabellänge: ca.1 Meter</li> <li>• Inkl. Batterie</li> </ul> | <ul style="list-style-type: none"> <li>• Temperature alarm, timer for setting</li> <li>• Tabletop and magnet-mountable</li> <li>• Probe length: 140 mm,</li> <li>• Cable length: approx. 1 meter</li> <li>• Incl. battery</li> </ul> |
|---|--|

#	°C	↔ mm
160054	-26 / +250	65 x 70



7

DE	ELEKTRONISCHER TIMER
EN	ELECTRONIC TIMER
IT	TIMER PROGRAMMABILE ELETTRONICO
ES	TEMPORIZADOR ELECTRÓNICO

- |  |   |
|--|---|
| <p>Count-Down-Timer mit Stoppuhr</p> <ul style="list-style-type: none"> <li>• 99 Min., 59 Sek.</li> <li>• Magnethalterung</li> <li>• Inkl. Batterie</li> </ul> | <p>Countdown timer with stopwatch</p> <ul style="list-style-type: none"> <li>• 99 minutes, 59 seconds.</li> <li>• Magnetic holder</li> <li>• Incl. battery</li> </ul> |
|--|---|

#	↔ mm
<input checked="" type="checkbox"/> 160018	70 x 53 x 8





DE	BACKHANDSCHUHE "PREMIUM"	
EN	BAKING MITTENS "PREMIUM"	
IT	GUANTI DA FORNO "PREMIUM"	
ES	MANOPLAS PARA HORNO "PREMIUM"	

- Baumwolle, Farbe natur
- Innenhand und Daumen verstärkt
- Hitzebeständig bis + 250 °C / max. 15 sec.
- Waschmaschinenfest bis + 40 °C
- Cotton, natural color
- Reinforced palm and thumb
- Heat resistant up to + 250 °C / max. 15 sec.
- Machine-washable up to + 40 °C

#	↗ mm	→ mm	
<input checked="" type="checkbox"/> 310001	270	150	



**Mit kurzen Stulpen**

**Short cuffs**

#	↗ mm	→ mm	
<input checked="" type="checkbox"/> 310002	340	160	

**„LADY“ – schmale Ausführung**

**“LADY” – slim version**

#	↗ mm	→ mm	
<input checked="" type="checkbox"/> 310103	340	140	



**Mit langen Stulpen**

**Long cuffs**

#	↗ mm	→ mm	
<input checked="" type="checkbox"/> 310003	400	150	



DE	BACKHANDSCHUHE "STANDARD"	
EN	BAKING MITTENS "STANDARD"	
IT	GUANTI DA FORNO "STANDARD"	
ES	GUANTES MANOPLAS PARA HORNO "STANDARD"	

- |   |   |
|---|---|
| <ul style="list-style-type: none"> <li>• Baumwolle, Farbe natur</li> <li>• Ganzflächig verstärkt</li> <li>• Hitzebeständig bis + 250°C / max. 15 sec.</li> <li>• Waschmaschinenfest bis + 40°C</li> </ul> | <ul style="list-style-type: none"> <li>• Cotton, natural color</li> <li>• Fully reinforced</li> <li>• Heat resistant up to + 250°C / max. 15 sec.</li> <li>• Machine-washable up to + 40°C</li> </ul> |
|---|---|

#	↗ mm	→ mm	
<input checked="" type="checkbox"/> 310019	325	150	



DE	BACKHANDSCHUHE SILIKON	
EN	BAKING MITTENS SILICONE	
IT	GUANTI DA FORNO IN SILICONE	
ES	GUANTES MANOPLAS DE SILICONA PARA HORNO 3 DEDOS	

- |   |   |
|---|---|
| <ul style="list-style-type: none"> <li>• 100% Silikon</li> <li>• Hitzebeständig bis + 250°C / max. 15 sec.</li> <li>• Flexibles Material</li> <li>• Wasserdicht, spülmaschinengeeignet</li> <li>• Hygienisch, sterilisierbar</li> </ul> | <ul style="list-style-type: none"> <li>• 100% silicone</li> <li>• Heat resistant up to + 250°C / max. 15 sec.</li> <li>• Flexible material</li> <li>• Waterproof, dishwasher safe</li> <li>• Hygienic, can be sterilised</li> </ul> |
|---|---|

#	↗ mm	→ mm	
310031	285	160	
310032	385	180	



DE	GASTROHANDSCHUH „SILIKON“	
EN	GASTRO MITTENS „SILICONE“	
IT	GUANTO GASTRO „SILICONE“	
ES	MANOPLAS GASTRO „SILICONA“	

- |  |   |
|--|---|
| <ul style="list-style-type: none"> <li>• Material: Silikon mit Baumwollfutter</li> <li>• Für Rechts- und Linkshänder</li> <li>• Zwischen Daumen und Zeigefinger verstärkt</li> <li>• Wasserdicht</li> <li>• Flexibles Material</li> <li>• Hitzebeständig bis + 250°C / max. 15 sec.</li> <li>• Handreinigung max. 30 – 40°C</li> </ul> | <ul style="list-style-type: none"> <li>• Made of silicone with cotton lining</li> <li>• For right- and left-handers</li> <li>• Reinforced between thumb and index finger</li> <li>• Waterproof</li> <li>• Flexible material</li> <li>• Heat resistant up to + 250°C / max. 15 sec.</li> <li>• Manual cleaning max. 30 – 40°C</li> </ul> |
|--|---|

#	↗ mm	→ mm	
<input checked="" type="checkbox"/> 310099	380	150	



DE	BACKHANDSCHUH NEOPREN	
EN	BAKING MITTENS NEOPRENE	
IT	GUANTO DA FORNO IN NEOPRENE	
ES	MANOPLAS NEOPRENE PARA HORNO	

- |   |   |
|---|---|
| <ul style="list-style-type: none"> <li>• Material: Neopren, schwarz</li> <li>• Für Rechts- und Linkshänder</li> <li>• Hitzebeständig bis + 250°C / max. 15 sec.</li> <li>• Rutschfest</li> <li>• Wasserabstoßendes und fleckenresistentes Material</li> <li>• Handreinigung max. 30 – 40°C</li> </ul> | <ul style="list-style-type: none"> <li>• Made of neoprene, black</li> <li>• For right- and left-handers</li> <li>• Heat resistant up to + 250°C / max. 15 sec.</li> <li>• Non-slip</li> <li>• Water repellent and stain resistant material</li> <li>• Manual cleaning max. 30 – 40°C</li> </ul> |
|---|---|

#	↗ mm	→ mm	
310085	350	145	





DE	BACKHANDSCHUHE LEDER	
EN	BAKING MITTENS LEATHER	
IT	GUANTI DA FORNO IN PELLE	
ES	MANOPLAS PARA HORNO EN CUERO	

- Leder, gefüttert
- Hitzebeständig bis +250°C / max. 15 sec.
- Nicht waschmaschinenfest
- Leather, inner lining
- Heat resistant up to +250°C / max. 15 sec.
- Not machine-washable

**Leder mit Stulpen**

**Leather with cuffs**

#	↗ mm	→ mm	
<input checked="" type="checkbox"/> 310111	450	140	

**„LADY” – schmale Ausführung**

**“LADY” – slim version**

#	↗ mm	→ mm	
<input checked="" type="checkbox"/> 310115	390	130	



- Leder, gefüttert
- Hitzebeständig bis +100°C / max. 15 sec.
- Nicht waschmaschinenfest
- Leather, inner lining
- Heat resistant up to +100°C / max. 15 sec.
- Not machine-washable

**“5 Finger” mit Stulpen**

**“5 fingers” with cuffs**

#	↗ mm	→ mm	
<input checked="" type="checkbox"/> 310023	450	140	



- Leder, gefüttert
- Hitzebeständig bis +100°C / max. 15 sec.
- Nicht waschmaschinenfest
- Leather, inner lining
- Heat resistant up to +100°C / max. 15 sec.
- Not machine-washable

**“3 Finger” mit Stulpen, speziell für das Entnehmen von kleinen Blechen**

**“3 fingers” with cuffs, especially for taking small tins**

#	↗ mm	→ mm	
<input checked="" type="checkbox"/> 310024	340	150	

EN 407



XXXXXX

O: Handschuhe erfüllen nicht die Mindestleistungsstufe  
 X: steht für Prüfung nicht durchgeführt

O: Gloves do not meet the minimum performance level  
 X: stands for test not performed

Leistungsstufe	Performance level	1	2	3	4
Brennverhalten (Sek.)	Burning behaviour (sec.)	≤ 20	≤ 10	≤ 3	≤ 2
Kontaktwärme (°C / Sek.)	Contact heat (°C / sec.)	100°C ≥ 15	250°C ≥ 15	350°C ≥ 15	500°C ≥ 15
Konvektive Wärme (Sek.)	Convective heat (sec.)	≥ 4	≥ 7	≥ 10	≥ 18
Strahlungswärme (Sek.)	Radiant heat (sec.)	≥ 5	≥ 30	≥ 90	≥ 150
Kleine Spritzer geschmolzenen Metalls (Anzahl)	Small splashes of molten metal (number)	≥ 5	≥ 15	≥ 25	≥ 35
Große Mengen flüssiges Metall (Gramm)	Large quantities of liquid metal (grams)	20	60	100	150

DE	BACKHANDSCHUHE LEDER
EN	BAKING MITTENS LEATHER
IT	GUANTI DA FORNO IN PELLE
ES	MANOPLAS PARA HORNO EN CUERO

- Leder, gefüttert
- Hitzebeständig bis + 100°C / max. 15 sec.
- Nicht waschmaschinenfest
- Leather, inner lining
- Heat resistant up to + 100°C / max. 15 sec.
- Not machine-washable

**Leder mit Stulpen**

**Leather with cuffs**

#	↗ mm	→ mm
<input checked="" type="checkbox"/> 310090	400	140



DE	BLECHANFASSER
EN	OVEN CLOTH
IT	PRESINA DA FORNO
ES	AGARRADOR PARA HORNO

- Baumwolle gesäumt
- Farbe natur
- Mit Griffflasche
- Hitzebeständig bis + 150°C
- Waschmaschinenfest bis + 40°C
- Cotton, reversible
- Natural color
- With grip tab
- Heat resistant up to + 150°C
- Machine-washable up to + 40°C

#	↗ mm	→ mm
<input checked="" type="checkbox"/> 310004	290	240



8

- Jute
- Farbe: natur
- Jute fibre mitten
- Natural color

#	↗ mm	→ mm
<input checked="" type="checkbox"/> 310009	250	200



DE	BAUMWOLLHANDSCHUHE "5 FINGER"
EN	GLOVES "5 FINGERS" – MADE OF COTTON
IT	GUANTI IN COTONE "5 DITA"
ES	GUANTES DE ALGODÓN "5 DEDOS"

- 100 % Baumwolle, weiß
- Pure cotton, white

#	↗ mm	→ mm
<input checked="" type="checkbox"/> 310027	240	100





DE	ZIP-HYGIENE-HANDSCHUH
EN	HYGIENE GLOVES
IT	GUANTI IGIENICI
ES	HIGIÉNICOS

Dieser Handschuh bietet vollständige Keimfreiheit beim Umgang mit Lebensmitteln. Insbesondere in Bäckereien oder der Gastronomie ist dieses Produkt eine schnelle und unkomplizierte Hilfe ohne ständig die Hände reinigen zu müssen. Durch die Benutzung wird eine direkte Berührung mit dem Lebensmittel verhindert. Die Anwendung beim Ein- und Ausschlüpfen ist durch das Verbindungselement mit einem automatischen Auf- und Abwickeln einer Zugschnur einfach und praktisch!

These gloves offer complete sterility while food is being handled. Especially in bakeries or in the food service trade they are a fast and easygoing help. It is not necessary to permanently wash the hands. By using these gloves a direct food contact is being prevented. The application of removing and inserting the hands is made simple and practical thru the use of a connecting element which automatically reels – and unreels the pull cord connected to the gloves.

#	Größe/size		
391530	G-50		50
391550	G-50/1	mit 1 Clip / with 1 clip	50 + 1
391535		Ersatzclip / replacement clip	1

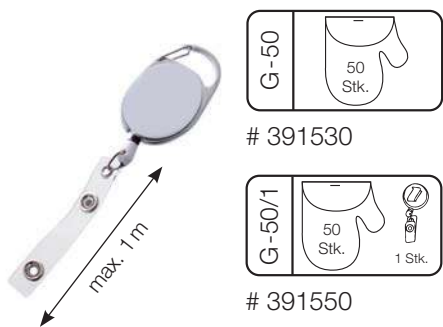

DE	ARBEITSSCHÜRZEN
EN	APRONS
IT	GREMBIULI
ES	DELANTALES

Material: beschichtete Baumwolle

- Reißfest und sehr stabil
- Gesäumt
- Hitzebeständig
- Einfach zu reinigen

Coated cotton

- Tear resistant
- Seamed
- Heat resistant
- Easy to clean

#	↔ mm	
120550	500 x 950	
120551	700 x 950	
120553	1000 x 950	mit Brustlatz / with bib
120554	1100 x 950	mit Brustlatz / with bib
120555	1200 x 1000	mit Brustlatz / with bib
120556	1300 x 1000	mit Brustlatz / with bib

Material: Baumwolle, weiß

- Gesäumt

Made of cotton, white

- Seamed

#	↔ mm
120557	450 x 800

DE	PAPIERMÜTZE "SCHIFFCHEN"
EN	LOW FORAGE HAT
IT	BUSTINA IN CARTA
ES	GORRO DE PAPEL "BARCO"

- Weiß, neutral
- Mit gelochtem Oberteil
- Verstellbar
- White, non-printed
- Perforated top
- Adjustable

#	↑ mm	
120100	85	1000



DE	KOCHMÜTZE "STANDARD"
EN	PLEATED CHEF'S HAT "STANDARD"
IT	CAPELLO DA CUOCO "STANDARD"
ES	GORRO COCINERO "STANDARD"

- Weiß, neutral
- Mit gelochtem Oberteil
- Verstellbar
- White, non-printed
- Perforated top
- Adjustable

#	↑ mm	
120200	216	250



8

DE	KOCHMÜTZEN "PREMIUM"
EN	PLEATED CHEF'S HAT "PREMIUM"
IT	CAPELLO DA CUOCO "PREMIUM"
ES	GORRO COCINERO "PREMIUM"

- Weiß, neutral
- Mit Schweißband
- Verstellbar
- White, non-printed
- With sweatband
- Adjustable

#	↑ mm	
120450	209	250



DE	KOCHMÜTZEN "MAITRE CHEF"
EN	PLEATED CHEF'S HAT "MAITRE CHEF"
IT	CAPELLO DA CUOCO "MAITRE CHEF"
ES	GORRO COCINERO "MAITRE CHEF"

- Weiß, neutral
- Plissiert
- Mit Schweißband
- Verstellbar
- White, non-printed
- Pleated
- With sweatband
- Adjustable

#	↑ mm	
120400	249	250





*So präsentieren Profis!*

MADE IN GERMANY

**Silikonfüße**

**Silicone feet**



#	↔ mm
227142	rund Ø: 16 / Höhe: 2 (12 Stk.) round Ø: 16 / height: 2 (12 pcs.)
227144	quadratisch: oben: 20 x 20; unten: 10 x 10 / H: 7 (7 Stk.) square: top: 20 x 20; bottom: 10 x 10 / height: 7 (7 pcs.)

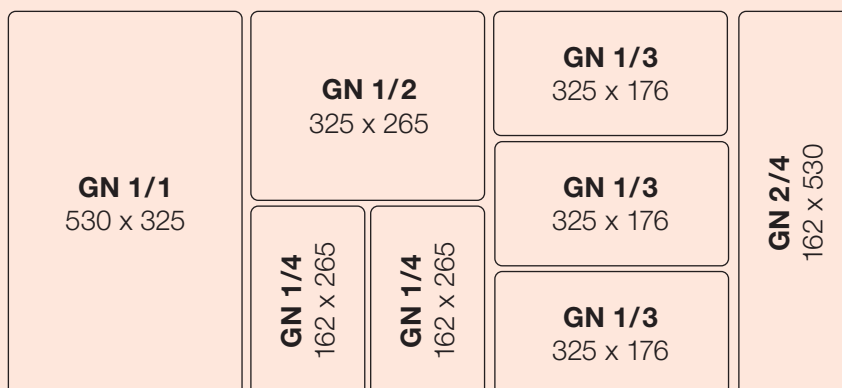
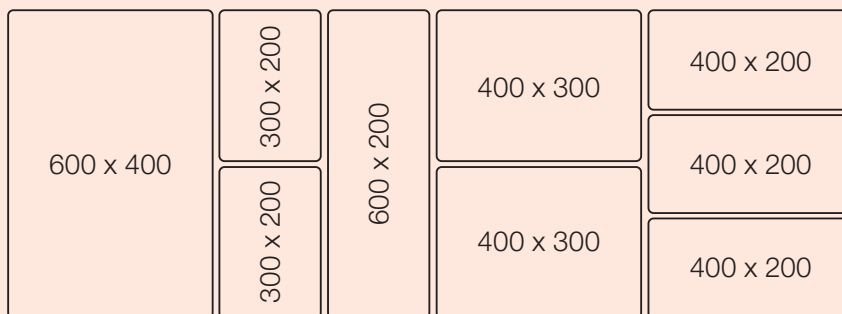

DE	AUSLAGETABLETTS "SCHIEFER"	
EN	DISPLAY TRAYS "SLATE"	
IT	VASSOI DA PRESENTAZIONE "ARDESIA"	
ES	BANDEJAS DE PRESENTACIÓN "PIZARRA"	

Material: mehrschichtige Kunststoffplatte

- Hygienisch, 100 % lebensmittelecht
- Spülmaschinengeeignet
- Leicht zu reinigen
- Stoß- und abriebfest
- Made in Germany
- Silikonfüße optional

**Materialstärke: 6 mm**

Made of multilayer plastic plate

- Hygienic, 100 % food safe
- Dishwasher proof
- Easy to clean
- Impact and abrasion resistant
- Made in Germany
- Optional accessory: silicone feet

**Thickness: 6 mm**



#		↔ mm	
225050		600 x 400	
225060		600 x 200	
225070		400 x 300	
225080		300 x 200	
225090		400 x 200	

225120		Ø: 320	
225130		Ø: 400	

225140	Tablett rund mit Griff / round tray with handle	Ø 320 x 465	
225150	Tablett rechteckig mit Griff / rectangular tray with handle	600 x 200	



**GN-Ausführungen**

**GN size display trays**

#	GN	↔ mm	
225250	1/1	530 x 325	
225260	1/2	325 x 265	
225270	1/3	325 x 176	
225280	1/4	265 x 162	
225290	2/4	530 x 162	



SAHARA  
DARK

DE	AUSLAGETABLETTS "SAHARA DARK"	
EN	TRAYS "SAHARA DARK"	
IT	VASSOI DA PRESENTAZIONE "SAHARA DARK"	
ES	BANDEJAS DE PRESENTACIÓN "SAHARA DARK"	

Material: mehrschichtige Kunststoffplatte

- Hygienisch, 100 % lebensmittelecht
- Spülmaschinengeeignet
- Leicht zu reinigen
- Stoß- und abriebfest
- Made in Germany
- Silikonfüße optional

**Materialstärke: 6 mm**

Made of multilayer plastic plate

- Hygienic, 100 % food safe
- Dishwasher proof
- Easy to clean
- Impact and abrasion resistant
- Made in Germany
- Optional accessory: silicone feet

**Thickness: 6 mm**

#		↔ mm	
226350		600 x 400	
226360		600 x 200	
226370		400 x 300	
226380		300 x 200	
226390		400 x 200	

226420		Ø: 320	
226430		Ø: 400	

226440	Tablett rund mit Griff / round tray with handle	Ø 320 x 465	
226450	Tablett rechteckig mit Griff / rectangular tray with handle	600 x 200	



**GN-Ausführungen**

**GN size display trays**

#	GN	↔ mm	
226550	1/1	530 x 325	
226560	1/2	325 x 265	
226570	1/3	325 x 176	
226580	1/4	265 x 162	
226590	2/4	530 x 162	





DE	AUSLAGETABLETTS "SAHARA LIGHT"
EN	DISPLAY TRAYS "SAHARA LIGHT"
IT	VASSOI DA PRESENTAZIONE "SAHARA LIGHT"
ES	BANDEJAS DE PRESENTACIÓN "SAHARA LIGHT"



SAHARA LIGHT

Material: mehrschichtige Kunststoffplatte

- Hygienisch, 100 % lebensmittelecht
- Spülmaschinegeeignet
- Leicht zu reinigen
- Stoß- und abriebfest
- Made in Germany
- Silikonfüße optional

**Materialstärke: 6 mm**

Made of multilayer plastic plate

- Hygienic, 100 % food safe
- Dishwasher proof
- Easy to clean
- Impact and abrasion resistant
- Made in Germany
- Optional accessory: silicone feet

**Thickness: 6 mm**

#		↔ mm	
226650		600 x 400	
226660		600 x 200	
226670		400 x 300	
226680		300 x 200	
226690		400 x 200	
226720		Ø: 320	
226730		Ø: 400	
226740	Tablett rund mit Griff / round tray with handle	Ø 320 x 465	
226750	Tablett rechteckig mit Griff / rectangular tray with handle	600 x 200	



**GN-Ausführungen**

**GN size display trays**

#	GN	↔ mm	
226850	1/1	530 x 325	
226860	1/2	325 x 265	
226870	1/3	325 x 176	
226880	1/4	265 x 162	
226890	2/4	530 x 162	





DE	AUSLAGETABLETTS	MF
EN	DISPLAY TRAYS	
IT	VASSOI DA PRESENTAZIONE	
ES	BANDEJAS DE PRESENTACIÓN	

Alle Artikel aus **Melamin** sind:

- Schnitt- und kratzfest, stapelbar
- Temperaturbeständig von -30 °C bis +70 °C



All products made of **melamine** are:

- Scratch and cut proof, stackable
- Temperature resistant from -30 °C up to +70 °C

#	↔ mm	
227003	190 x 150 x 17	● Schwarz / black
227004	190 x 150 x 17	○ Weiß / white
227007	270 x 210 x 17	● Schwarz / black
227008	270 x 210 x 17	○ Weiß / white
227009	300 x 150 x 17	● Schwarz / black
227010	300 x 150 x 17	○ Weiß / white
227011	300 x 190 x 17	● Schwarz / black
227012	300 x 190 x 17	○ Weiß / white
227013	350 x 240 x 17	● Schwarz / black
227014	350 x 240 x 17	○ Weiß / white
227015	420 x 280 x 20	● Schwarz / black
227016	420 x 280 x 20	○ Weiß / white
227094	580 x 195 x 20	● Schwarz / black
227095	580 x 195 x 20	○ Weiß / white
227096	600 x 400 x 20	● Schwarz / black
227097	600 x 400 x 20	○ Weiß / white

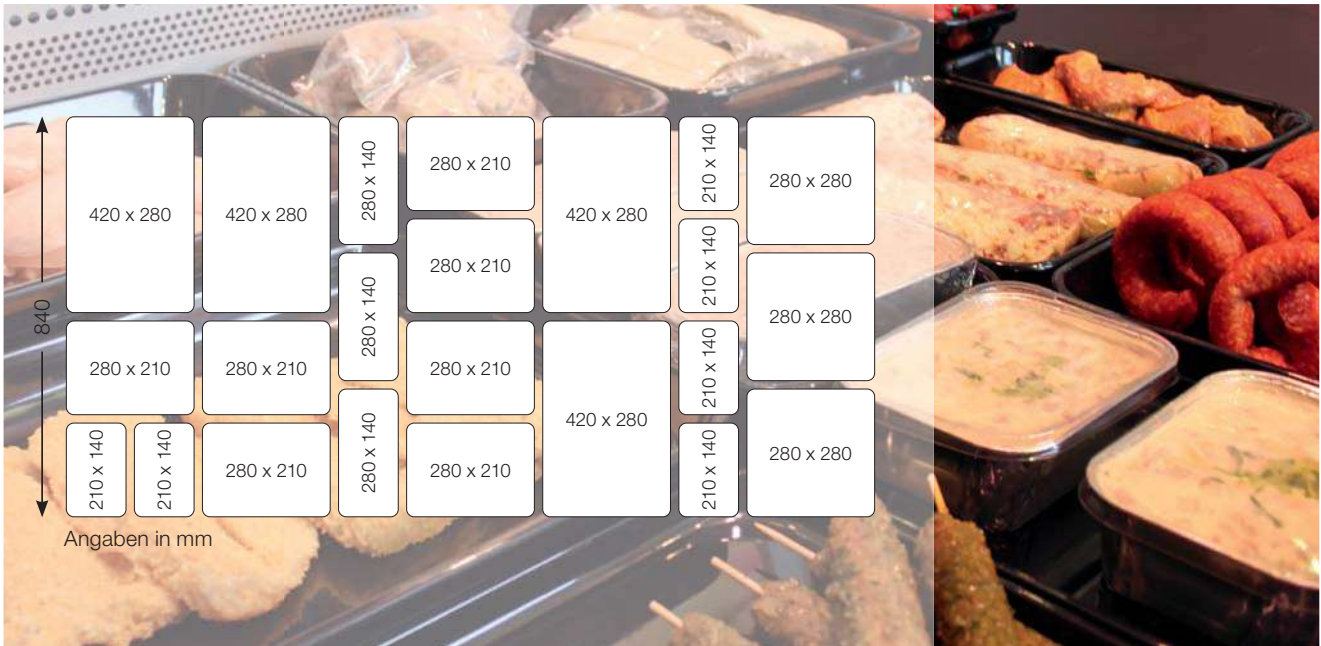



DE	AUSLAGETABLETTS UND AUSLAGESCHALEN	 
EN	DISPLAY TRAYS	
IT	VASSOI DA PRESENTAZIONE	
ES	BANDEJAS DE PRESENTACIÓN	

Für Metzgertheke / Fleischertheke mit 84 cm Tiefe. Silikonfüße optional.  
 Alle Artikel aus **Melamin** sind:  
 • Spülmaschinengeeignet  
 • Schnitt- und kratzfest, stapelbar  
 • Temperaturbeständig von -30 °C bis + 70 °C

For counters in butcher shops with 84 cm depth, silicone feet optional  
 All products made of **melamine** are:  
 • Dishwasher safe  
 • Scratch and cut proof, stackable  
 • Temperature resistant from -30 °C up to + 70 °C

#	↔ mm		 ml
227130	280 x 210 x 22	● Schwarz / black	800
227131	280 x 210 x 43	● Schwarz / black	2600
227132	280 x 210 x 76	● Schwarz / black	2300
227133	420 x 280 x 22	● Schwarz / black	1600
227134	420 x 280 x 43	● Schwarz / black	3300
227135	420 x 280 x 76	● Schwarz / black	5600
227136	280 x 280 x 43	● Schwarz / black	1900
227137	280 x 280 x 76	● Schwarz / black	3800
227138	280 x 140 x 43	● Schwarz / black	900
227139	280 x 140 x 76	● Schwarz / black	1500
227140	210 x 140 x 43	● Schwarz / black	600
227141	210 x 140 x 76	● Schwarz / black	1100
227142	Silikonfüße (50 Stk.)	silicone feet (50 pcs.)	



9



DE	SERVIERTABLETTS OVAL
EN	SERVING TRAYS OVAL
IT	VASSOI DA PORTATA OVALI
ES	BANDEJAS OVALADAS

Material: Edelstahl

Made of stainless steel

- Mit gebördeltem Rand
- Hochglanzpoliert

- With rolled edge edge
- Mirror-polished



#	↔ mm
154040	145 x 200
154041	180 x 230
154042	195 x 265
154043	220 x 285

Material: Edelstahl

Made of stainless steel

- Mit gebördeltem Rand
- Oberfläche matt

- With rolled edge
- Matte finish



#	↔ mm
155040	145 x 200
155041	180 x 230
155042	195 x 265
155043	220 x 285

DE	AUSLAGETABLETTS / SERVIERTABLETTS
EN	DISPLAY TRAYS
IT	VASSOI DA PRESENTAZIONE
ES	BANDEJAS DE PRESENTACIÓN

Material: Edelstahl

Made of stainless steel

- Mit umgelegtem Rand
- Poliert

- With beaded edge
- Polished



#	↗ mm	→ mm	↑ mm
154021	200	160	12
154024	300	160	12
154025	310	210	12
154026	340	240	12
154028	400	300	12

Material: Edelstahl

Made of stainless steel

- Mit geradem Rand
- Poliert

- With plain edge
- Polished



#	↗ mm	→ mm	↑ mm
154030	195	145	10
154031	280	140	10
154032	290	185	10
154033	320	220	10
154034	380	280	10

DE	KUCHEN- & TORTENPLATTEN / KÖNIGSKUCHENPLATTEN	
EN	CAKE PLATES	MF
IT	PIATTI PER DOLCI	
ES	SOPORTES PARA TARTAS	

Material: **Melamin**

- Schnitt- und bruchfest

Made of **melamine**

- Cut and break proof

#		↔ mm	
227023	Königskuchenplatte, weiß / loaf cake plate, white	400 x 150 x 20	
227098	Königskuchenplatte, schwarz / loaf cake plate, black	400 x 150 x 20	



DE	AUSLAGETABLETTS	
EN	DISPLAY TRAYS	
IT	VASSOI DA PRESENTAZIONE	
ES	BANDEJAS DE PRESENTACIÓN	

Material: ABS, schwarz

- Bruchfest, genarbt
- Randhöhe: 20 mm
- Abgeklappter Rand: 12 mm
- Spülmaschinengeeignet bis ca. + 80 °C
- Temperaturbeständig bis ca. + 80 °C

Made of ABS, black

- Unbreakable, surface grained
- Border height: 20 mm
- Curved rim: 12 mm
- Dishwashe safe up to approx. + 80 °C
- Heat resistant up to approx. + 80 °C

#	↗ mm	→ mm	
227640	400	300	



- Genarbt
- Spülmaschinengeeignet bis ca. + 80 °C
- Temperaturbeständig bis ca. + 80 °C

- Surface grained
- Dishwashe safe up to approx. + 80 °C
- Heat resistant up to approx. + 80 °C

#	↗ mm	→ mm	↑ mm	
227601	400	600	20	
227611	300	400	20	
227621	195	580	20	
227622	300	190	20	





DE	AUSSTELLBLECHE / THEKENBLECHE	
EN	DISPLAY TRAYS	
IT	VASSOI DA ESPOSIZIONE	
ES	BANDEJAS PARA EXPOSICIÓN	

Material: Aluminium  
 • Pulverbeschichtet  
 • Farbe: schwarz

Made of aluminium  
 • Powder coated  
 • Color: black

**Ausführung / Type: 4 Seiten 90° / 4 sides 90°**

#	↗ mm	→ mm	↑ mm
154095	600	200	10
154096	600	400	10
154098	400	300	10
154099	300	200	10

**THEKENBLECHE MIT OFFENEN ECKEN**

Material: Edelstahl

**WITH OPEN EDGES**

Made of stainless steel



**Ausführung / Type: 4 Seiten 90° / 4 sides 90°**

#	↗ mm	→ mm	↑ mm
154060	600	400	15
154061	600	200	15



DE	THEKENABTRENUNG
EN	COUNTER SEPARATOR
IT	SEPARATORE PER BANCO
ES	SEPARADOR DE MOSTRADOR

Material: Acryl

Made of acrylic

#	↔ mm
172700	700 x 170
172710	560 x 170

DE	AUSSTELLBLECHE / THEKENBLECHE
EN	DISPLAY TRAYS
IT	VASSOI DA ESPOSIZIONE
ES	BANDEJAS PARA EXPOSICIÓN



**SILBER**

Material: Aluminium, gebeizt

- Mit handelsüblichem Spülmittel reinigen
- Nicht spülmaschinengeeignet

**SILVER**

Made of pickled aluminium

- Cleaning with any standard detergent
- Not dishwasher safe

#	↗ mm	→ mm	↑ mm
154050	600	400	20
154051	480	320	20
154052	400	250	20
154053	600	200	20
154059	300	200	20
154054	600	400	10
154055	480	320	10
154056	400	250	10



**GOLD**

Material: Aluminium, eloxiert

- Mit handelsüblichem Spülmittel reinigen
- Nicht spülmaschinengeeignet

**GOLD**

Made of anodized aluminium

- Cleaning with any standard detergent
- Not dishwasher safe

#	↗ mm	→ mm	↑ mm
154070	600	400	20
154071	480	320	20
154072	400	250	20
154074	600	200	20
154073	600	400	10



**CHAMPAGNER**

Material: Aluminium, eloxiert

- Mit handelsüblichem Spülmittel reinigen
- Nicht spülmaschinengeeignet

**CHAMPAGNE**

Made of anodized aluminium

- Cleaning with any standard detergent
- Not dishwasher safe

#	↗ mm	→ mm	↑ mm
154080	600	400	10
154081	480	320	10
154082	400	300	10
154083	400	250	10
154084	600	200	10



DE	THEKENBLECH / SNACK-BLECH
EN	SNACK SALES RACK
IT	TEGLIA PER SNACK
ES	PORTA BOCADILLOS



Material: Aluminium, pulverbeschichtet

- Schwarz
- Nicht spülmaschinengeeignet

Made of aluminium, powder coated

- Black
- Not dishwasher safe

#	↔ mm
154089	600 x 200 x 20





DE	SNACK-VERKAUFSSTÄNDER / SNACKWELLEN – WELLENFORM	
EN	SNACK SALES RACKS – WAVY	
IT	PORTA SNACK	
ES	PORTA BOCADILLOS	

**WELLENFORM**

Material: ABS, schwarz

- Bruchfest, genarbt
- Spülmaschinengeeignet bis ca. + 80 °C
- Temperaturbeständig bis ca. + 80 °C

**Optimal für # 227621**

**WAVY**

Made of ABS, black

- Unbreakable, surface grained
- Dishwasher safe up to approx. + 80 °C
- Heat resistant up to approx. + 80 °C

**Ideal for # 227621**

#	↗ mm	→ mm	↑ mm		
227651	560	85	58	6	
227650	560	168	58	6	



Material: PS

- Matt-schwarz

Made of PS

- Matt black

#	↗ mm	→ mm	↑ mm		
227552	530	85	45	6	



Material: Acryl

- Transparent

Made of acryl

- Transparent

#	↗ mm	→ mm	↑ mm		
172500	580	85	45	6	
172510	580	170	45	6	



Material: Kunststoff

- Spülmaschinengeeignet

Made of plastic

- Dishwasher safe

#	↗ mm	→ mm	↑ mm		
227550	600	195	70	6	
227551	290	190	60	3	



DE	SNACK-VERKAUFSSTÄNDER / SNACKWELLEN – WELLENFORM
EN	SNACK SALES RACKS – WAVY
IT	PORTA SNACK
ES	PORTA BOCADILLOS



Material: Aluminium, schwarz  
 • Pulverbeschichtet,  
 • Nicht spülmaschinengeeignet

Made of aluminium, black,  
 • Powder coated  
 • Not dishwasher proof

#	↗ mm	→ mm	↑ mm	≡	
154090	580	85	40	6	
154091	580	170	40	6	



Material: Edelstahl  
 • Spülmaschinengeeignet

Made of stainless steel  
 • Dishwasher safe

#	↗ mm	→ mm	↑ mm	≡	
154065	370	85	35	4	
154066	370	175	35	4	
154093	560	85	35	7	
154094	560	175	35	7	

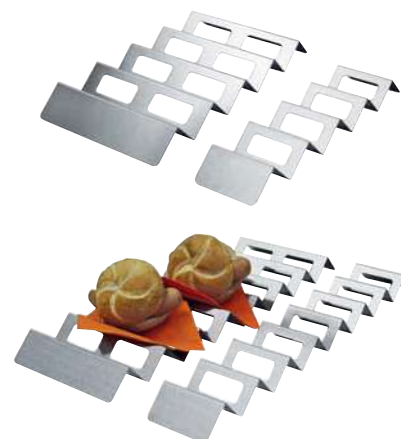

#	↗ mm	→ mm	↑ mm	≡	
154011	320	200	80	2	
154012	280	170	45	3	

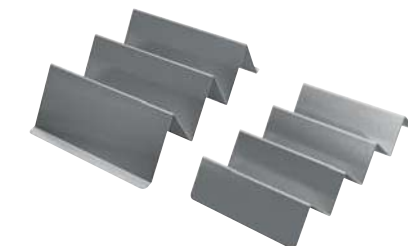

Material: Edelstahl, gelocht  
 • Spülmaschinengeeignet

Made of stainless steel, perforated  
 • Dishwasher safe

#	↗ mm	→ mm	↑ mm	≡	
154037	590	190	45	6	

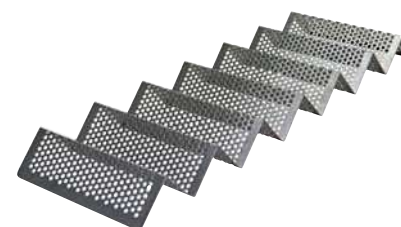

DE	WRAP-HALTER
EN	WRAP HOLDER
IT	PORTA WRAPS
ES	PORTA WRAPS

Material: Edelstahl

Made of stainless steel

#	↗ mm	→ mm	↑ mm	
172530	600	67	40	



Material: Acryl  
 • Transparent  
 • Mit Boden  
 • Zur Präsentation von 12 Wraps  
 • Lochdurchmesser 70 mm

Made of acryl  
 • Transparent  
 • With bottom  
 • For the presentation of 12 wraps  
 • Diameter of holes 70 mm

#	↗ mm	→ mm	↑ mm	
172520	560	195	50	



DE	TORTENPLATTEN / HALBKREIS	
EN	CAKE PLATES	MF
IT	ALZATE PER TORTA	
ES	SOPORTES PARA TARTAS	



**Tortenplatte-Halbkreis** in zwei Farben – aus dickwandigem **Melamin**

- Temperaturbeständig von -30 °C bis +70 °C
- Schnitt- und kratzfest, stapelbar
- Spülmaschinengeeignet
- Mit Silikonfüßen

**Cake display** in 2 colors: heavy, high quality **melamine**; **semi-circle**

- Temperature resistant -30 °C up to +70 °C
- Scratch and cut proof, stackable
- Dishwasher safe
- Silicone feet included

#		↔ mm / Ø	↑ mm
227026	○ Weiß / white	160 / 320	30
227126	● Schwarz / black	160 / 320	30



DE	TORTENPLATTEN	
EN	CAKE PLATES	MF
IT	ALZATE PER TORTA	
ES	SOPORTES PARA TARTAS	



# 227029, 227025, 227027



# 227129, 227125, 227127



# 227229, 227225, 227227

Material: **Melamin**

- Schnitt- und bruchfest
- Mit Anti-Rutsch-Füßen

Made of **melamine**

- Cut and break proof
- With anti-slip feet

#		Ø mm	↑ mm
227029	○ Weiß / white	240	30
227025	○ Weiß / white	300	30
227027	○ Weiß / white	320	30
227129	● Schwarz / black	240	30
227125	● Schwarz / black	300	30
227127	● Schwarz / black	320	30
227229	● Silber / silver	240	30
227225	● Silber / silver	300	30
227227	● Silber / silver	320	30



DE	TORTENPLATTEN		
EN	CAKE PLATES	MF	drehbar
IT	ALZATE PER TORTA		
ES	SOPORTES PARA TARTAS		

- Material: **Melamin**
- Schnitt- und bruchfest
  - Mit Anti-Rutsch-Füßen

- Made of **melamine**
- Cut and break proof
  - With anti-slip feet

#		Ø mm	↑ mm
227028	weiß, drehbar, mit Fuß / white, turnable, with foot	320	100
227128	schwarz, drehbar, mit Fuß / black, turnable, with foot	320	100



DE	TORTEN- UND DEKORIERPLATTE			
EN	TILTING CAKE DECORATING	MF	drehbar	
IT	ALZATA GIREVOLE E INCLINABILE PER DECORARE TORTE			
ES	SOPORTE GIRATORIO INCLINABLE PARA DECORAR TARTAS			

- Material: **Melamin, Kunststoff**
- Dreh- und schwenkbar
  - Stabile Qualität
  - Inkl. Anti-Rutsch-Füßen
  - rutschfeste Oberfläche

- Made of **melamine, plastic**
- Turnable
  - Tilting
  - Sturdy
  - With anti-slip feet and top

#	Ø mm	↑ mm
227220	300	160



DE	TORTENPLATTE			
EN	CAKE PLATE	ALU	drehbar	
IT	ALZATE PER TORTA			
ES	SOPORTES PARA TARTAS			

- Material: **Aluminium**
- Drehbar
  - Stabile Qualität
  - Anti-Rutsch Boden

- Made of **aluminium**
- Turnable
  - Sturdy
  - Anti-slip bottom

#	Ø mm	↑ mm
154018	310	130





DE	TORTENPLATTEN
EN	CAKE PLATES
IT	ALZATE PER TORTA
ES	SOPORTES PARA TARTAS

Material: Edelstahl  
 • Poliert,  
 • Mit Ringfuß  
 • Materialstärke: 1 mm

Made of stainless steel  
 • Polished  
 • With round foot  
 • Thickness: 1 mm

#	Ø mm	↑ mm	
154010	240	30	
154001	300	30	
154002	330	30	
154004	360	30	

**i** Andere Größen auf Anfrage. / Other sizes upon request.



Material: Edelstahl  
 • Matt poliert  
 • Mit geschlossenem Boden  
 • Bodenteil aus einem Stück  
 • Materialstärke: 3,2 mm

Made of stainless steel  
 • Matte finish, hygienic  
 • With closed bottom  
 • Closed bottom part  
 • Thickness: 3.2 mm

#	↑ Ø mm	↓ Ø mm	↑ mm	
154003	315	220	35	



DE	TORTENPLATTE, RECHTECKIG
EN	CAKE PLATE, RECTANGULAR
IT	ALZATA RETTANGOLARE PER TORTE
ES	SOPORTE RECTANGULAR PARA TARTAS

Material: Edelstahl

Made of stainless steel



#	↔ mm	↑ mm	
154020	395 x 160	30	

DE	ABDECKHAUBEN / TORTENHAUBEN
EN	PROTECTION COVERS
IT	CAMPANE
ES	TAPAS PROTECTORAS

Material: PS  
 • Glasklar

Made of PS  
 • Crystal clear



#	Ø mm	↑ mm
227150	300	70
227160	300	100
227170	335	120

Material: PE  
 • Milchig  
 • Unzerbrechlich

Made of PE  
 • Translucent  
 • Unbreakable



#	Ø mm	↑ mm
227031	300	120

Material: PP  
 • Milchig  
 • Unzerbrechlich

Made of PP  
 • Translucent  
 • Unbreakable

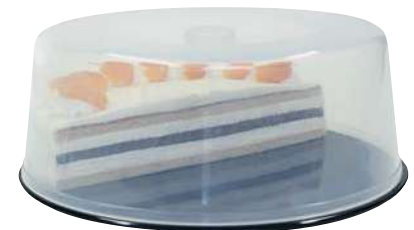

Anwendungsbeispiel /  
Application example

#	Ø mm	↑ mm
227037	300	110

Material: PET  
 • Stärke: 1 mm  
 • Für Bleche 400 x 600 mm  
 • Stapelbar

Made of PET  
 • Thickness: 1 mm  
 • For trays 400 x 600 mm  
 • Stackable

#	↔ mm
227180	620 x 425 x 105





DE	SAHNE-ABDECKPAPIERE "ZELLGLAS"
EN	CREAM COVERS "CELLOPHANE"
IT	FOGLIETTI SEPARATORI PER ALIMENTI "CELLOFAN"
ES	HOJAS SEPARADORAS PARA REPOSTERÍA "CELOFÁN"

Zellglas, transparent  
 • Flächengewicht 35 g/m<sup>2</sup>

Made of cellophane, transparent  
 • Grammage 35 g/m<sup>2</sup>

#	↗ mm	→ mm		🛒 kg
114001	120	180	1/32	5
114002	180	250	1/16	5
114003	240	360	1/8	5



DE	SAHNE-ABDECKPAPIERE "NON PLUS ULTRA"
EN	CREAM COVERS "NON PLUS ULTRA"
IT	FOGLIETTI SEPARATORI PER ALIMENTI "NON PLUS ULTRA"
ES	HOJAS SEPARADORAS PARA REPOSTERÍA "NON PLUS ULTRA"

• Im Spendenkarton á 1000 Blatt  
 • Sehr hohe Fettdichte  
 • Kompostierbar

• In dispenser box á 1000 sheets  
 • Very high grease density  
 • Compostable

#	↗ mm	→ mm	🛒 Blatt
113040	120	180	1000
113041	180	240	1000
113042	240	360	1000



DE	FETTPAPIERHALTER
EN	DISPENSERS FOR GREASE-PROOF PAPERS
IT	DISPENSER PER CARTA RESISTENTE AI GRASSI
ES	DISPENSADOR DE PAPEL MANTEQUILLA

Material: Acryl, transparent  
 • Selbstklemmend

Made of acryl, transparent  
 • Self-mounting

#		↔ mm
172000	zur Ablage von DIN A 6-Papieren / storage and dispensing of paper sheets (ca. 125 x 187 mm)	130 x 190 x 65
172001	zur Ablage von DIN A 6-Papieren / storage and dispensing of paper sheets (ca. 125 x 187 mm)	190 x 135 x 65
172002	zur Ablage von DIN A 5-Papieren / storage and dispensing of paper sheets (ca. 187 x 250 mm)	255 x 185 x 65
172003	zur Ablage von DIN A 4-Papieren / storage and dispensing of paper sheets (ca. 250 x 375 mm)	380 x 260 x 65



DE	PRÄSENTIER-STÄNDER / SCHNITTKUCHENBRÜCKE
EN	DISPLAY RISER FOR SLICED CAKES
IT	ALZATA ESPOSITORE PER TORTE A FETTE
ES	SOPORTE PARA REBANADAS DE PASTELES

Material: Acryl, transparent

Made of acrylic, transparent

#	für / for	→ mm	↑ mm	↓ mm
227575	995810 + 997810	106	80	70
227576	995820 + 997820	206	80	70

DE	RAHMEN FÜR SCHNITTKUCHENBLECH	NICHT zum Backen geeignet! NOT for baking!
EN	FRAME FOR CAKE DISPLAY SHEET	
IT	BASE PER TEGLIE PORTA TORTE	
ES	CONTENEDORES DE BANDEJAS PARA TORTA	

- |                          |                       |
|--------------------------|-----------------------|
| Material: PS, schwarz    | Made of PS, black     |
| • Genarbt                | • Surface grained     |
| • Eine kurze Seite offen | • One short side open |

#	für / for	→ mm	↑ mm	↓ mm
227577	995810 + 997810	115	55	590
227578	995820 + 997820	215	55	590



DE	TORTENSCHUTZ TS PLAST 1 + 2 GES. GESCH.
EN	CAKE PROTECTION TS PLAST 1 + 2 PAT.
IT	PROTEZIONE PER TORTA TS PLAST 1 + 2
ES	PROTECCIÓN PARA TORTA TS PLAST 1 + 2

- |   |   |
|---|---|
| Material: HPVC glasklar   | Made of HPVC, transparent   |
| • Bewahrt den Torten-Anschnitt vor Austrocknung und schützt das Aroma | • Protects the aroma by preventing the desiccation of the sliced cake |

#		
113500	Set besteht aus je 25 linken und rechten Teilen Set consisting of 25 left and right pieces	1 Set = 50 Stück

 TS Plast 1 und 2 reinigt man mit lauwarmem Wasser (bis zu 50 °C) unter Zugabe eines beliebigen Spülmittels / cleaning of TS Plast 1+2 with warm water (max. 50 °C) and standard washing-up liquid



DE	KUNSTSTOFF-BAND / TORTENRANDFOLIE
EN	PLASTIC RIBBONS
IT	NASTRI DI PLASTICA
ES	CINTAS DE PLÁSTICO

#	↗ m	→ mm	μ
114026**	300	40	37
114030**	300	60	37

#	↗ m	↑ mm	μ
114050*	200	25	80
114051*	200	30	80
114052*	200	35	80
114053*	200	40	80
114054*	200	45	80
114055*	200	50	80
114056*	200	55	80
114057*	200	60	80

#	↗ mm	→ mm	μ	
114021**	300	60	50	1000
114022**	240	40	50	1000
114023**	240	30	50	1000
114024**	150	25	50	1000
114060*	600	400	80	1 Pkg. à 50 Blatt
114061*	300	300	80	1 Pkg. à 50 Blatt

- |                            |                               |
|----------------------------|-------------------------------|
| *Material: PVC, glasklar   | *Made of PVC, crystal clear   |
| **Material: HPVC, glasklar | **Made of HPVC, crystal clear |



DE	TORTENSPITZEN, WEISS
EN	DOILIES, WHITE
IT	PIZZI PER TORTE, BIANCHI
ES	BLONDAS BLANCAS



#		Ø mm			
116010	rund / round	100	250	5000	
116013	rund / round	120	250	2000	
116014	rund / round	140	250	2000	
116017	rund / round	165	250	2000	
116018	rund / round	190	250	2000	
116022	rund / round	220	100	2000	
116026	rund / round	240	100	2000	
116028	rund / round	270	100	2000	
116030	rund / round	290	100	2000	
116033	rund / round	300	100	2000	
116034	rund / round	320	100	2000	
116036	rund / round	340	100	1000	
116038	rund / round	360	100	1000	
116040	rund / round	380	100	1000	
116046	rund / round	420	100	1000	



#		↔ mm			
116100	oval	180 x 260	250	10000	
116110	oval	160 x 230	250	2000	
116130	oval	210 x 320	250	2000	
116210	oval	320 x 450	100	2000	
116410	Rechteckig / rectangular	170 x 300	100	1000	
116430	Rechteckig / rectangular	200 x 400	100	1000	
116440	Rechteckig / rectangular	300 x 400	100	1000	
116450	Rechteckig / rectangular	350 x 450	100	1000	
116480	Rechteckig / rectangular	250 x 370	100	1000	



DE	TORTENSPITZEN-SET
EN	SET OF DOILIES FOR CAKE STANDS
IT	SET DI PIZZI PER TORTE
ES	JUEGO DE BLONDAS

- Für 3- und 4-teilig Tortenständer
- For cake stands with 3 and 4 tiers

#	für / for: Ø mm	Set
116333	3-teilig / 3-tiers (200 / 260 / 320)	à 100 Stk./pcs.
116444	4-teilig / 4-tiers (200 / 260 / 320 / 400)	à 100 Stk./pcs.



DE	ETAGEN-TORTENSTÄNDER / HOCHZEITSTORTENSTÄNDER
EN	CAKE STANDS
IT	ALZATE PER TORTA IN ALLUMINIO
ES	SOPORTES PARA TARTAS EN ALUMINIO

Material: Aluminium

- Für Hochzeiten, Büffets in der Gastronomie oder für Warenpräsentationen
- Sehr stabile Ausführung

• **Abstand zwischen den Etagen 16,5 cm**

Made of aluminium

- Usable for wedding cakes, buffets or for displaying pastries etc.
- Sturdy

• **Distance between tiers 16.5 cm**

#	Ø mm		↑ mm
146003	200/260/320	3	380
146004	200/260/320/400	4	546
146005	200/260/320/400/450	5	712
146006	200/260/320/400/450/500	6	878
146007	160/200/260/320/400/450/500	7	1044
146008	160/200/260/320/400/450/500/550	8	1210



# 146003

# 146004

# 146005

# 146007

DE	ERSATZTEILE
EN	SPARE PARTS
IT	PEZZI DI RICAMBIO
ES	PIEZAS DE REPUESTO

#		↔ mm
148016	Ersatzscheibe / disc	160
148020	Ersatzscheibe / disc	200
148026	Ersatzscheibe / disc	260
148032	Ersatzscheibe / disc	320
148040	Ersatzscheibe / disc	400
148045	Ersatzscheibe / disc	450
148050	Ersatzscheibe / disc	500
148051	Ersatzscheibe / disc	550
148002	Kopfschraube / head screw	
148003	Schraube für Fuß / screw for foot	
148004	Außenfuß mit Schraube / outside foot with screw	
148005	Zwischenstück (Säule) / connection (pillar) 165	
148007	Zwischenstück (Säule) / connection (pillar) 82	
148008	Zwischenstück (Säule) / connection (pillar) 52	
148006	Mittelfuß / middle foot	
148001	Mittelloch ausstecher aus Edelstahl / center hole cutter made of stainless steel	



# 148001



#148008 #148007 #148005



DE	ETAGEN-TORTENSTÄNDER / HOCHZEITSTORTENSTÄNDER
EN	CAKE STANDS
IT	ALZATE PER TORTA
ES	SOPORTES PARA TARTAS

Material: PS

Made of PS

#		Ø mm
200108	2	250 / 340
200103	3	200 / 250 / 340
200104	4	200 / 250 / 320 / 340
200105	5	200 / 250 / 320 / 400 / 440

Ersatzteile / Spare parts

200106	Mittelfuß / Middle foot (PP)
200102	Schraube / Screw
200109	Zwischenstück / Intermediate piece



DE	ETAGEN-TORTENSTÄNDER / HOCHZEITSTORTENSTÄNDER
EN	CAKE STANDS
IT	ALZATE PER TORTA
ES	SOPORTES PARA TARTAS

Material: weißer Kunststoff

Made of white plastic

- Spülmaschinenfest
- Zur einmaligen oder mehrmaligen Verwendung
- Stecksystem – einfach zu montieren
- Jede Scheibe benötigt 4 Säulen
- Dishwasher safe
- For single or multiple use
- Plug-in system – easy to install
- Each disc requires 4 columns

#	Ø mm
202400	150
202401	175
202402	200
202403	225
202404	250
202405	275
202406	300
202407	325
202408	350
202409	375
202410	400
202411	450



#	↑ mm
202412	75
202413	150
202414	225

DE	ETAGEN-TORTENSTÄNDER / HOCHZEITSTORTENSTÄNDER
EN	CAKE STANDS
IT	ALZATE PER TORTA
ES	SOPORTES PARA TARTAS

Material: Aluminium

- Sehr stabile Ausführung
- Für Hochzeiten, Büffets in der Gastronomie oder für Warenpräsentationen
- **Individuell gestaltbar**

Made of aluminium

- Sturdy
- Usable for wedding cakes, buffets or for displaying pastries etc.
- **Individually designable**

#		↑ mm	Ø mm
146040	5	380	200/2 x 260/2 x 320



Material: Aluminium

- Mit vorspringenden Auslegern
- Schwerer Fuß
- Abstand zwischen den Etagen 16,5 cm

Made of aluminium

- With projecting cantilevers
- With heavy foot
- Distance between tiers 16.5 cm

#		Ø mm
149004	4-Etagen / 4 tiers	320

Erstteile / Spare parts

149007	Ausleger / Cantilever
149008	Schraube / Screw
149009	Mutter / Screw nut
149010	Sockel / Stand





DE	TORTENHEBER
EN	CAKE SERVERS
IT	PALETTE PER TORTA
ES	PALETAS PARA TORTAS

Material: Edelstahl

Made of stainless steel

#		↕ mm	↗ mm	
199030	aus einem Stück, schwere Qualität / in one piece, heavy quality	128 x 55	275	
199035	aus einem Stück, rechteckig / in one piece, rectangular	120 x 60	240	
199036	aus einem Stück, mit Spitze / in one piece, pointed	120 x 55	240	
<input checked="" type="checkbox"/> 149900	poliert / polished		Ø: 280	



DE	TORTENHEBER
EN	CAKE SERVERS
IT	PALETTE PER TORTA
ES	PALETAS PARA TORTAS

Material: Edelstahl

Made of stainless steel

- Kunststoffgriff, schwarz

- Plastic handle, black

#		↕ mm	↗ mm	
<input checked="" type="checkbox"/> 199038	stumpf / blunt	105 x 63	275	
<input checked="" type="checkbox"/> 199039	Welle / Wave	105 x 63	275	

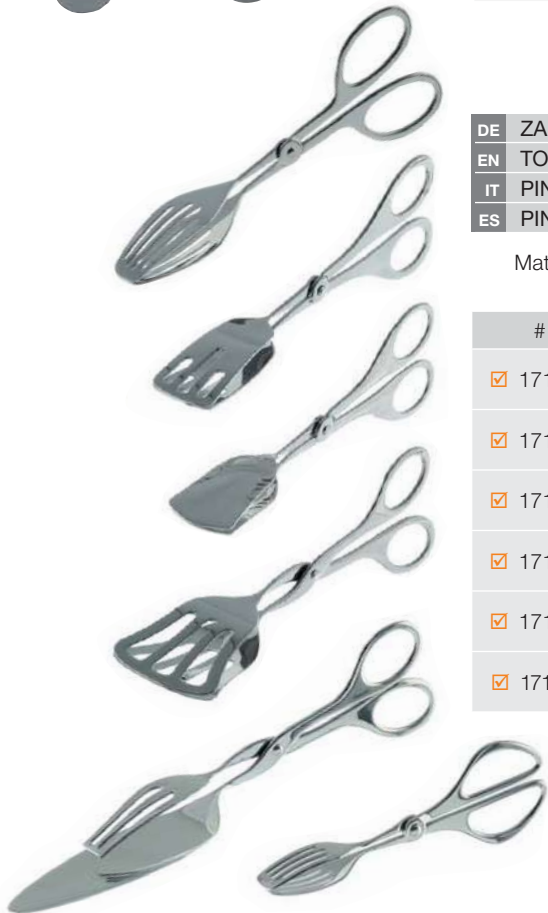

DE	ZANGEN
EN	TONGS
IT	PINZE
ES	PINZAS

Material: Edelstahl, aus einem Stück

Made of stainless steel, in one piece

#		↔ mm	
<input checked="" type="checkbox"/> 171000	Gebäckzange, offen / pastry tongs, open	190 x 36	
<input checked="" type="checkbox"/> 171001	Gebäckzange, offen / pastry tongs, open	185 x 34	
<input checked="" type="checkbox"/> 171002	Gebäckzange, offen / pastry tongs, open	180 x 36	
<input checked="" type="checkbox"/> 171003	Gebäckzange, offen / pastry tongs, open	190 x 56	
<input checked="" type="checkbox"/> 171004	Tortenzange / cake tongs	230 x 20 x 53	
<input checked="" type="checkbox"/> 171005	Konfektzange, offen / confectionery tongs, open	145 x 21	

DE	NUDELZANGEN
EN	PASTA TONGS
IT	PINZE PER LA PASTA
ES	PINZAS PARA PASTA

- Material: Edelstahl
- Poliert
  - Aus einem Stück

- Made of stainless steel
- Polished
  - In one piece

#	↗ mm	↔ mm	
<input checked="" type="checkbox"/> 171100	205	80 x 35	



DE	SALATZANGEN
EN	SALAD TONGS
IT	PINZE PER INSALATA
ES	PINZAS PARA ENSALADA

- Material: Edelstahl
- Poliert
  - Aus einem Stück

- Made of stainless steel
- Polished
  - In one piece

#	↗ mm	↔ mm	
<input checked="" type="checkbox"/> 171101	240	75 x 50	



DE	UNIVERSALZANGEN
EN	CATERING TONGS
IT	PINZA UNIVERSALE
ES	PINZA UNIVERSAL

- Material: Edelstahl
- Poliert
  - Aus einem Stück

- Made of stainless steel
- Polished
  - In one piece

#	↗ mm	↔ mm	
<input checked="" type="checkbox"/> 171103	210	50 x 38	
<input checked="" type="checkbox"/> 171104	215	68 x 48	
<input checked="" type="checkbox"/> 171105	210	50 x 38	



DE	SANDWICH ZANGEN
EN	SANDWICH TONGS
IT	PINZE PER PANINI
ES	PINZAS PARA SANDWICHES

- Material: Edelstahl
- Poliert
  - Aus einem Stück

- Made of stainless steel
- Polished
  - In one piece

#	↗ mm	↔ mm	
<input checked="" type="checkbox"/> 171106	190	75 x 32	



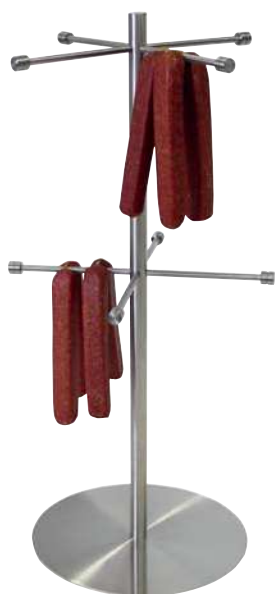

DE	BREZEL-/ WURSTSTÄNDER
EN	PRETZEL/ SAUSAGE STAND
IT	PORTA PRETZEL/ SALSICCIA
ES	SOPORTE PARA PRETZELS Y SALCHICHAS

SST



- Selbstmontage
- Ausführung: 8-armig
- Self-assembly
- Type: with 8 arms

#	∅ mm	↑ mm	
154812	210	500	



DE	BREZEL-/ WURSTSTÄNDER
EN	PRETZEL/ SAUSAGE STAND
IT	PORTA PRETZEL/ SALSICCIA
ES	SOPORTE PARA PRETZELS Y SALCHICHAS

WOOD

- Ausführung: 6-armig
- Type: with 6 arms

#	∅ mm	↑ mm	
120641	150	500	



DE	SPUCK / NIESSCHUTZ
EN	PROTECTION
IT	PROTEZIONE
ES	PROTECCIÓN

Material: Acryl

Made of acrylic

#	∅ mm	↑ mm	
172401	370	500	

DE	ALLZWECKZANGEN
EN	MULTI PURPOSE TONGS
IT	PINZE MULTIUSO
ES	PINZAS MULTIUSOS

- Material: Edelstahl
- Griff Kunststoff
  - Schwere Qualität

- Made of stainless steel
- Plastic handle
  - Heavy quality

#		↗ mm
<input checked="" type="checkbox"/> 171040	● Schwarz/black	230
<input checked="" type="checkbox"/> 171041	● Schwarz/black	300
<input checked="" type="checkbox"/> 171042	● Schwarz/black	400
<input checked="" type="checkbox"/> 171061	● Rot/red	300
<input checked="" type="checkbox"/> 171062	● Blau/blue	300
<input checked="" type="checkbox"/> 171063	● Grün/green	300
<input checked="" type="checkbox"/> 171064	● Gelb/yellow	300

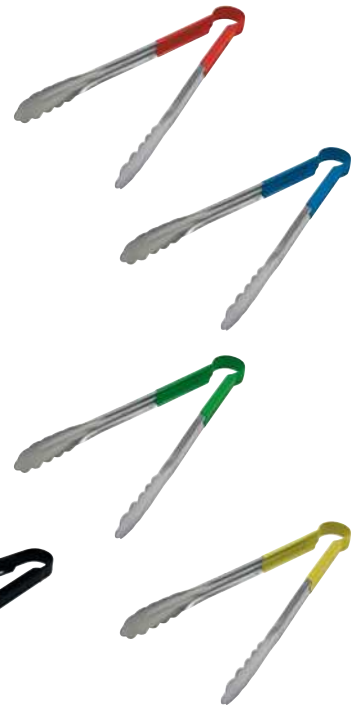

DE	ALLZWECKZANGEN
EN	MULTI PURPOSE TONGS
IT	PINZE MULTIUSO
ES	PINZAS MULTIUSOS

- Material: Edelstahl
- Griff und Blatt aus Silikon
  - Mit Verschleißmechanismus und Aufhänge-Öse
  - Schwere Qualität

- Made of stainless steel
- Handle and blade made of silicone
  - With closing mechanism and suspension eyelet
  - Heavy quality

#		↗ mm
<input checked="" type="checkbox"/> 171050	● Schwarz/black	230
<input checked="" type="checkbox"/> 171051	● Schwarz/black	300
<input checked="" type="checkbox"/> 171052	● Schwarz/black	400



9

DE	GRILL / SERVIERZANGEN
EN	GRILL /SERVING TONGS
IT	PINZE PER BARBECUE
ES	PINZAS PARA BARBACOA

Material: Edelstahl

Made of stainless steel

#		↗ mm
172415		220
172416		320

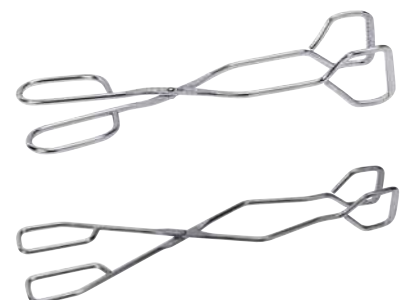



DE	WINKELPALETTEN
EN	ANGULAR SPATULAS
IT	SPATOLE ANGOLARI
ES	ESPÁTULAS CURVADAS

Material: Aluminium

Made of aluminium

#	↖ mm	→ mm	
227214	175 / 310	35	



DE	WURSTZANGEN
EN	SAUSAGE TONGS
IT	PINZE PER SALSICCE
ES	PINZAS PARA SALCHICHAS

Material: Edelstahl

Made of stainless steel

- Aus einem Stück
- Greifende gewellt

- Seamless
- Gripping end wavy

#		↔ mm	
172413	gebogen / bended	339 x 50 x 60	
172414	gerade / straight	354 x 68 x 24	



DE	PINZETTEN ZANGEN
EN	PRECISION TWEEZER TONGS
IT	PINZE DI PRECISIONE
ES	PINZAS DE PRECISIÓN

Material: Edelstahl

Made of stainless steel

#		↔ mm	
171020	gerade / straight	200	
171030	gebogen / bended	200	



Material: PPA, schwarz

Made of PPA, black

- Hitzebeständig bis + 220 °C

- Heat resistant up to + 220 °C

#		↔ mm	
<input checked="" type="checkbox"/> 172370	Pinzette / tweezers	305 x 18	



DE	THEKENPRÄSENTER
EN	SHOWCASES
IT	ESPOSITORI DA BANCO
ES	VITRINAS EXPOSITORAS

Material: PC

Made of PC

- Transparent
- 2-teilig

- Transparent
- 2 pieces

#	↗ mm	→ mm	↑ mm	
172670	430	280	140	



DE	THEKENAUFSTELLER
EN	SHOWCASES
IT	VETRINE DA BANCO
ES	VITRINAS EXPOSITORAS

Material: Acryl

• Mit 3 Auslagetabletts aus PC

• Mit hochklappbarem Entnahmedeckel

Made of acrylic

• With 3 trays made of PC

• With removable flip lid

#	↗ mm	→ mm	↑ mm
172630	340	250	340



Material: Acryl

Made of acrylic

#		↔ mm
172600	für 1 Blech 200 x 600 mm / for 1 tray 200 x 600 mm	635 x 260 x 200
172610	für 2 Bleche 200 x 600 mm / for 2 trays 200 x 600 mm	635 x 260 x 400



9

DE	THEKENAUFSTELLER FÜR HYGIENISCHEN SCHUTZ / SPUCKSCHUTZ
GB	COUNTER SHOWCASE WITH SNEEZE GUARD
IT	PARAFIATO DA BANCO CON MENSOLA
ES	VITRINA MAMPARA PARA BARRA DE PROTECCION HIGIÉNICA

Material: Acryl, farblos

• Gebogene Form

• Materialstärke: 4 mm

Made of acrylic

• Bent shape

• Thickness: 4 mm

#	↗ mm	→ mm	↑ mm
172431	600	220	200
172432	540	220	200



Material: Acryl

• Für Tablett und Bleche

200 x 600 mm + 400 x 600 mm

Made of acrylic

• For trays 200 x 600 mm

+ 400 x 600 mm

#	↗ mm	→ mm	↑ mm
172430	610	290	300



DE	KÜHLPLATTEN	
EN	COOLING TRAYS	
IT	VASSOI REFRIGERATI	
ES	BANDEJAS REFRIGERADAS	



- Material: Edelstahl  
 • Integrierte Kühlelemente fest verschlossen  
 • Bei -20° ca. 4 Stunden gefrieren
- Made of stainless steel  
 • Integrated cooling elements firmly closed  
 • Freeze at -20° for approx. 4 hours

#		↗ mm	→ mm	↑ mm	
281020	GN 1/1	530	325	45	
281021	GN 1/2	325	265	45	



DE	TISCHAUFSTELLER / PREISSCHILDER
EN	TABLETOP MENU BOARDS
IT	LAVAGNETTE DA TAVOLA
ES	PIZZARAS DE MESA



**Ausführung: L-Form**

- Material: PVC, schwarz  
 • Materialstärke: 3 mm  
 • Mit Kreidestiften zu beschriften  
 • Abwischbar  
 • Set à 5 Stk.

**Design: L-shape**

- Material: PVC, black  
 • Thickness: 3 mm  
 • Can be written on with chalk markers  
 • Wipeable  
 • Set of 5 pcs.

#	→ mm	↑ mm		
198950	105	148	DIN A6	
198951	148	210	DIN A5	
198952	210	297	DIN A4	



**Ausführung: mit lackiertem Naturholzfuß**

- Material: PVC, schwarz  
 • Materialstärke: 3 mm  
 • Mit Kreidestiften zu beschriften  
 • Abwischbar

**Design: with lacquered natural wood base**

- Material: PVC, black  
 • Thickness: 3 mm  
 • Can be written on with chalk markers  
 • Wipeable

#	→ mm	↑ mm		
198960	138	65		
198961	138	105		
198962	138	190		

DE	KREIDESTIFTE
EN	CHALK MARKERS
IT	PENNARELLI A GESSO LIQUIDO
ES	MARCADORES DE YESO LÍQUIDO

- Mit feuchtem Tuch und Wasser abwischbar
- Schreibt auf allen glatten Oberflächen (Kreidetafeln, Glas, Spiegel, Kunststoff, Metall, Fliesen, etc.)
- Clean with water
- Writes on all glossy surfaces (chalkboards, glass, mirrors, plastics, metals, tiles, etc.)

#		→ mm
198920	○ Weiß / white	2
198900	○ Weiß / white	5
198901	● Blau / blue	5
198902	● Gelb / yellow	5
198903	● Grün / green	5
198904	● Orange / orange	5
198905	● Rot / red	5
198910	○ Weiß / white	15
198911	● Blau / blue	15
198912	● Gelb / yellow	15
198913	● Grün / green	15
198914	● Orange / orange	15
198915	● Rot / red	15



DE	KELLNER-/NOTABLOCKS
EN	WAITER PADS
IT	BLOC-NOTES PER CAMERIERI
ES	COMANDAS PARA CAMAREROS

- Neutrale Blocks
- 40 Blatt pro Block
- Farblose Kopfverleimung
- Verpackung: 2 x 25 Blocks in Folie
- Unprinted
- 40 sheets
- Colorless glue
- 2 x 25 notepads packed

#	↔ mm		
711000	70 x 150	holzfrei, weiß / woodfree 60 g / m <sup>2</sup>	50
710000	70 x 150	Zeitungsdruckpapier / newsprint / 49 g / m <sup>2</sup>	50



9

DE	THERMO-GUEST-CHEQUES
EN	THERMO-GUEST-CHEQUES
IT	RICEVUTE FISCALI DI CARTA TERMICA (PER SPESE DI RAPPRESENTANZA)
ES	RECIBOS DE HOSPITALIDAD DE PAPEL TÉRMICO









Sondergrößen auf Anfrage.

Special sizes upon request.

#	↔ mm		
820601	120 x 210 0/1-farbig bedruckt "gesetzl. Bewirtungsnachweis"	○ Weiß / white	3500





	MEHRWEG	MULTI USE
 	<p><b>„MASTERFLEX“</b></p> <ul style="list-style-type: none"> <li>• Für höchste Ansprüche, 100% lebensmittelecht</li> </ul>	<p><b>„MASTERFLEX“</b></p> <ul style="list-style-type: none"> <li>• For top requirements, 100 % food-safe</li> </ul>
 	<p><b>„EXPORT“</b></p> <ul style="list-style-type: none"> <li>• Dickes Material</li> <li>• Für den Konditor</li> <li>• Mit Tüllenverstärkung</li> <li>• Mit oberem Saum und Aufhänger</li> </ul>	<p><b>„EXPORT“</b></p> <ul style="list-style-type: none"> <li>• Thick material</li> <li>• For the confectioner</li> <li>• With reinforced tip</li> <li>• With upper seam and hanger</li> </ul>
 	<p><b>„STANDARD“</b></p> <ul style="list-style-type: none"> <li>• Softe Oberfläche</li> <li>• Mit Tüllenverstärkung</li> <li>• Mit oberem Saum und Aufhänger</li> </ul>	<p><b>„STANDARD“</b></p> <ul style="list-style-type: none"> <li>• Soft surface</li> <li>• With reinforced tip</li> <li>• With upper seam and hanger</li> </ul>
 	<p><b>„PREMIUM“</b></p> <ul style="list-style-type: none"> <li>• Flexibel</li> <li>• Synthetik</li> <li>• Mit oberem Saum und Aufhänger</li> </ul>	<p><b>„PREMIUM“</b></p> <ul style="list-style-type: none"> <li>• Flexible</li> <li>• Synthetic</li> <li>• With upper seam and hanger</li> </ul>



	EINWEG	DISPOSABLE	
	<ul style="list-style-type: none"> <li>• Blau-transparent</li> <li>• Außen griffig</li> <li>• Spitze geschlossen</li> <li>• Für alle Massen geeignet</li> </ul>	<ul style="list-style-type: none"> <li>• Blue-transparent</li> <li>• Non-slip exterior</li> <li>• Closed tip</li> <li>• For all fillings</li> </ul>	- 20 / +70°C
	<ul style="list-style-type: none"> <li>• Grün-transparent</li> <li>• Spitze geschlossen</li> <li>• Für alle Massen geeignet</li> </ul>	<ul style="list-style-type: none"> <li>• Green-transparent</li> <li>• Closed tip</li> <li>• For all fillings</li> </ul>	- 20 / +70°C
	<ul style="list-style-type: none"> <li>• Biologisch abbaubar und kompostierbar</li> <li>• Hell-Beige</li> <li>• Nicht geeignet für sehr schwere oder dicken Massen</li> </ul>	<ul style="list-style-type: none"> <li>• Biodegradable and compostable</li> <li>• Off-white</li> <li>• Not suitable for very heavy or thick masses</li> </ul>	- 20 / +70°C
	<ul style="list-style-type: none"> <li>• Orange-transparent</li> <li>• Außen extrem griffig</li> <li>• Spitze geschlossen</li> <li>• Für alle Massen geeignet – (speziell für schwere und warme Massen)</li> </ul>	<ul style="list-style-type: none"> <li>• Orange-transparent</li> <li>• Extreme non-slip exterior</li> <li>• Closed tip</li> <li>• For all fillings – (great for heavy consistencies and hot products)</li> </ul>	- 20 / +70°C
	<ul style="list-style-type: none"> <li>• Transparent</li> <li>• Spitze geschlossen</li> <li>• Für alle Massen geeignet</li> </ul>	<ul style="list-style-type: none"> <li>• Transparent</li> <li>• Closed tip</li> <li>• For all fillings</li> </ul>	- 20 / +70°C
	<ul style="list-style-type: none"> <li>• <b>Doppelspritzbeutel mit Trenneinlage</b></li> <li>• Transparent</li> <li>• Spitze geschlossen</li> <li>• Für zwei verschiedene Massen geeignet</li> </ul>	<ul style="list-style-type: none"> <li>• <b>Double-compartment pastry bag</b></li> <li>• Transparent</li> <li>• Closed tip</li> <li>• For two differnt fillings</li> </ul>	- 20 / +70°C
	<ul style="list-style-type: none"> <li>• <b>“Zipper”</b> zum Verschließen</li> <li>• Transparent</li> <li>• Mit Skala und Beschriftungsfeld</li> <li>• Spitze geschlossen</li> <li>• Für alle Massen geeignet</li> </ul>	<ul style="list-style-type: none"> <li>• With zip-lock</li> <li>• Transparent</li> <li>• With measurement guide and labelling field</li> <li>• Closed tip</li> <li>• For all fillings</li> </ul>	- 20 / +70°C



DE	SPRITZBEUTEL "EXPORT"	
EN	PASTRY BAGS "EXPORT"	
IT	SAC À POCHE "EXPORT"	
ES	MANGAS "EXPORT"	

- |  |   |
|--|---|
| <ul style="list-style-type: none"> <li>• Beschichtete Baumwolle</li> <li>• Lebensmittelecht</li> <li>• Verschweißte Längsnaht</li> <li>• Mehrmals verwendbar</li> <li>• Undurchlässig</li> </ul> | <ul style="list-style-type: none"> <li>• Coated cotton</li> <li>• Food safe</li> <li>• Welded seam</li> <li>• Useable several times</li> <li>• Impermeable</li> </ul> |
|--|---|

**Mit Saum und Tüllenverstärkung**

**With upper seam and reinforced tip**

#	Größe / size	↗ mm	
350080	0	250	
350081	1	280	
350082	2	340	
350083	3	400	
350084	4	460	
350085	5	500	
350086	6	550	
350087	7	600	
350088	8	650	
350089	9	700	
350090	10	750	



DE	SPRITZBEUTEL "STANDARD"	
EN	PASTRY BAGS "STANDARD"	
IT	SAC À POCHE "STANDARD"	
ES	MANGAS "STANDARD"	

- |  |   |
|--|---|
| <ul style="list-style-type: none"> <li>• Beschichtete Baumwolle</li> <li>• Lebensmittelecht</li> <li>• Verschweißte Längsnaht</li> <li>• Mehrmals verwendbar</li> <li>• Undurchlässig</li> </ul> | <ul style="list-style-type: none"> <li>• Coated cotton</li> <li>• Food safe</li> <li>• Welded seam</li> <li>• Useable several times</li> <li>• Impermeable</li> </ul> |
|--|---|

**Mit Saum und Tüllenverstärkung**

**With upper seam and reinforced tip**

#	Größe / size	↗ mm	
350170	0	250	
350171	1	280	
350172	2	340	
350173	3	400	
350174	4	460	
350175	5	500	
350176	6	550	
350177	7	600	
350178	8	650	
350179	9	700	
350180	10	750	

DE	SPRITZBEUTEL "MASTERFLEX"
EN	PASTRY BAGS "MASTERFLEX"
IT	SAC À POCHE "MASTERFLEX"
ES	MANGAS "MASTERFLEX"



- |  |  |
|--|--|
| <ul style="list-style-type: none"> <li>• Für höchste Ansprüche</li> <li>• 100 % lebensmittelecht</li> <li>• Längsnaht verschweißt</li> <li>• Mit Aufhänger</li> <li>• Innenseite glatt</li> <li>• Außenseite griffig</li> <li>• Flexibles Material (Polyurethan)</li> <li>• Undurchlässig</li> <li>• Auch für Mikrowelle geeignet</li> </ul> | <ul style="list-style-type: none"> <li>• For highest requirements</li> <li>• 100 % food safe</li> <li>• Welded seam</li> <li>• With hanging loop</li> <li>• Inner surface smooth</li> <li>• Outer surface grippy</li> <li>• Flexible material (Polyurethane)</li> <li>• Impermeable</li> <li>• Suitable for microwave</li> </ul> |
|--|--|

#	Größe / size	↗ mm
330002	2	340
330003	3	400
330004	4	460
330005	5	500
330007	7	600



DE	SPRITZBEUTEL "PREMIUM"
EN	PASTRY BAGS "PREMIUM"
IT	SAC À POCHE "PREMIUM"
ES	MANGAS "PREMIUM"



- |  |   |
|--|---|
| <ul style="list-style-type: none"> <li>• Synthetisches Gewebe, beschichtet</li> <li>• Lebensmittelecht</li> <li>• Mit Aufhänger</li> <li>• Mehrmals verwendbar</li> <li>• Undurchlässig</li> </ul> | <ul style="list-style-type: none"> <li>• Synthetic fabric, coated</li> <li>• Food safe</li> <li>• Including hanger</li> <li>• Useable several times</li> <li>• Impermeable</li> </ul> |
|--|---|

#	Größe / size	↗ mm
350250	0	250
350251	1	280
350252	2	340
350253	3	400
350254	4	460
350255	5	500
350256	6	550
350257	7	600
350258	8	650
350259	9	700
350260	10	750





DE	HAUSHALTS-SPRITZBEUTEL	
EN	PASTRY BAGS FOR DOMESTIC USE	
IT	SAC À POCHE – USO DOMESTICO	
ES	MANGAS – USO CASERO	

- Beschichtete Baumwolle
- Lebensmittelrecht
- Undurchlässig
- Mehrmals verwendbar,
- Ohne Saum und ohne Aufhänger
- Coated cotton
- Food safe
- Impermeable
- Useable several times
- Without seam and without hanger

Mit 2-teiligem Schraubadapter, 3 Sterntüllen, 1 Lochtülle, 1 Dekortülle und 1 Berlinertülle  
 With special adapter, 3 star tubes, 1 plain tube, 1 decoration tube and 1 fritter tube

#	Größe / size	↗ mm	
<input checked="" type="checkbox"/> 350144	1	280	
<input checked="" type="checkbox"/> 350145	1a	310	



DE	TÜLLEN-ADAPTER-SET	
EN	EXTERNAL PIPING TUBE ADAPTER SET	
IT	SET DI BOCCHETTE CON ADATTATORE	
ES	JUEGO DE BOQUILLAS CON ADAPTADOR	

- Material: PP, weiß  
 Made of PP, white
- 6-teilig
  - Schraubverschluss
  - 6 pieces
  - With screw top

#		
350147	3 Sterntüllen, 1 Lochtülle, 1 Dekortülle, 1 Berliner Tülle / 3 star tubes, 1 plain tube, 1 decoration tube, 1 fritter tube	



DE	DEKOR-SPRITZBEUTEL	
EN	DECORATING BAG	
IT	SAC À POCHE PER DECORARE	
ES	MANGA PARA DECORAR	

- Gewebe, beschichtet
- Längsnaht verklebt, ganz geschlossen
- Lebensmittelrecht
- Undurchlässig
- Mehrmals verwendbar
- Fabrics, coated cotton
- Glued seam, with closed tip
- Food safe
- Impermeable
- Useable several times

#	↗ mm	
350650	210	1 Beutel = 5 Stk. / 1 bag = 5 pcs.



DE	DEKOR-SPRITZBEUTEL "PERGAMYN"	
EN	DECORATING BAGS "PERGAMYN"	
IT	SACCHETTI PER DECORARE "PERGAMINA"	
ES	MANGAS PARA DECORAR "PERGAMINO"	

- Material: Pergamyn  
 Made of pergamyn
- Mit oder ohne Tülle verwendbar
  - Useable with or without tube

#	↗ mm	
350600	210	1000 Stk. / pcs.
350601	370	1000 Stk. / pcs.



DE	SPRITZBEUTEL-WANDAUFHÄNGER
EN	WALL RACKS FOR PASTRY BAGS
IT	SUPPORTI PER SAC À POCHÉ E BOCCHETTE
ES	COLGADORES DE MANGAS Y BOQUILLAS

- Sehr stabile Ausführung
- Verpackt im Einzelkarton
- Für 4 Spritzbeutel und 31 Tüllen maximal verwendbar
- Inkl. Kleingeräteablage und 5 Haken
- Sturdy
- Single packing
- For 4 pastry bags and 31 piping tubes
- With rack for depositing small tools with 5 hooks

#		↔ mm	
157000	weiß beschichtet / coated in white plastic	500 x 500	
157001	Edelstahl / made of stainless steel	500 x 500	

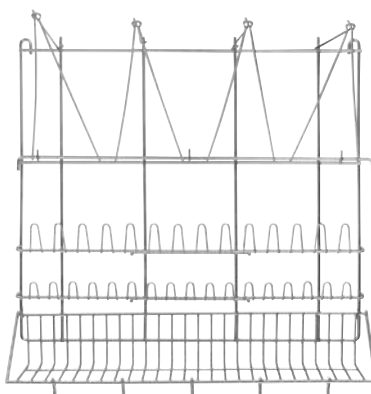

DE	SPRITZBEUTEL-ABSETZSTÄNDER
EN	SUPPORT FOR PASTRY BAGS
IT	SUPPORTO PER SAC À POCHÉ
ES	SOPORTE PARA MANGAS

- Material: PP, Farbe elfenbein
- Stabil
  - Mit 8 Aussparungen für 4 große und 4 kleine Spritztüllen
- Made of PP, ivory
- Sturdy
  - With holes for 4 large and 4 small tubes

#	↓ Ø mm	↑ mm	
157002	195	230	



10

DE	VERSCHLUSS-CLIP
EN	FASTENING CLIPS
IT	CLIP DI CHIUSURA
ES	CLIPS CIERRA BOLSAS

- Material: PP
- Zum dichten Verschließen von Spritzbeuteln und Vorratsbeuteln
  - Spülmaschinenfest
- Made of PP
- For closing of pastry bags and other bags
  - Dishwasher proof

#	↗ mm		
<input checked="" type="checkbox"/> 391900	 125	mit Messer / including blade	6
<input checked="" type="checkbox"/> 391902	 285	mit abnehmbarem Griff / with twist-on handle	4

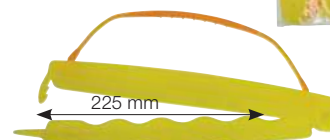

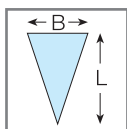

DE	EINWEG-SPRITZBEUTEL – GEROLLT
EN	DISPOSABLE PASTRY BAGS – ROLLED
IT	SAC A POCHE USA E GETTA – ARROTOLATO
ES	MANGAS PASTELERAS DESECHABLES – ENROLLADAS

Material: PE, **mehrfach extrudiert**

- Blau-transparent, hygienisch
  - Glatte Innenseite
  - Mit Abreißperforation
  - Hohe Reißfestigkeit der Schweißnaht
  - Spitze geschlossen mit / ohne Tülle verwendbar
  - Karton mit Entnahmeöffnung
- 100 Stk. / Box**

Material: PE, **multiple layers**

- Blue-transparent, hygienic
  - Smooth inside
  - With tear-off perforation
  - High tensile strength of the weld seam
  - Tip closed usable with / without tube
  - Carton with removal opening
- 100 pcs. / Box**

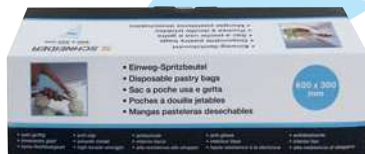

#	↗ mm	→ mm	μ	
391200	350	195	75	
391210	470	230	75	
391220	530	275	75	
391230	600	300	75	
391240	300	160	75	

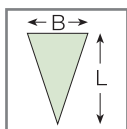

DE	EINWEG-SPRITZBEUTEL – GEROLLT „ECO“
EN	DISPOSABLE PASTRY BAGS – ROLLED „ECO“
IT	SAC A POCHE USA E GETTA – ARROTOLATO „ECO“
ES	MANGAS PASTELERAS DESECHABLES – ENROLLADAS „ECO“

Material: PE, **dreifach extrudiert**

- Grün-transparent, hygienisch
  - Glatte Innenseite
  - Mit Abreißperforation
  - Hohe Reißfestigkeit der Schweißnaht
  - Spitze geschlossen mit / ohne Tülle verwendbar
  - Karton mit Entnahmeöffnung
- 100 Stk. / Box**

Material: PE, **3-layers**

- Green-transparent, hygienic
  - Smooth inside
  - With tear-off perforation
  - High tensile strength of the weld seam
  - Tip closed usable with / without tube
  - Carton with removal opening
- 100 pcs. / Box**

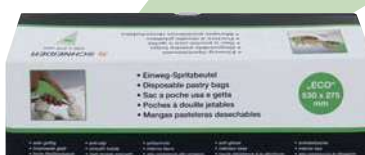

#	↗ mm	→ mm	μ	
391800	350	195	70	
391810	470	230	70	
391820	530	275	70	

DE	EINWEG-SPRITZBEUTEL – GEROLLT
EN	DISPOSABLE PASTRY BAGS – ROLLED
IT	SAC A POCHES USA E GETTA – ARROTOLATO
ES	MANGAS PASTELERAS DESECHABLES – ENROLLADAS

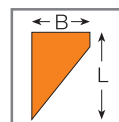

- Material: PE, **dreifach extrudiert**
- Orange, hygienisch
  - Extrem griffig
  - Glatte Innenseite
  - Mit Abreißperforation
  - Auch mit nassen / fettigen Händen einsetzbar
  - Für alle Massen (warm, kalt, fest) geeignet
  - Mikrowellentauglich
  - Hohe Reißfestigkeit der Schweißnaht
  - Spitze geschlossen mit / ohne Tülle verwendbar
  - Karton mit Entnahmeöffnung

**100 Stk. / Box**

- Material: PE, **3-layers**
- Orange, hygienic
  - Extremely grippy
  - Smooth inside
  - With tear-off perforation
  - Also usable with wet / greasy hands
  - Suitable for all masses (warm, cold, solid)
  - Microwaveable
  - High tensile strength of the weld seam
  - Tip closed usable with / without tube
  - Carton with removal opening

**100 pcs. / Box**



#	↗ mm	→ mm	μ	
391320	530	280	80	
391330	590	280	80	

DE	EINWEG-SPRITZBEUTEL – GEROLLT „KOMPOSTIERBAR“
EN	DISPOSABLE PASTRY BAGS – ROLLED “COMPOSTABLE”
IT	SAC A POCHES USA E GETTA – ARROTOLATO “COMPOSTABILE”
ES	MANGAS PASTELERAS DESECHABLES – ENROLLADAS “COMPOSTABLE”

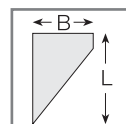

- Hergestellt aus biologisch abbaubaren und kompostierbaren Rohstoffen gemäß EN13432 (industrielle Kompostierbarkeit)
- Haltbarkeit: 1 Jahr ab Produktionsdatum
- Farbe: Hell-Beige
- Glatte innere Beutelschicht für optimalen Durchfluss
- Nicht geeignet für sehr schwere oder dicken Massen
- Sterile Beutellinnenseite
- Hohe Reiß- und Durchstoßfestigkeit
- Karton mit Entnahmeöffnung

**72 Stk. / Box**

- Made from biodegradable and compostable raw materials according to EN13432 (industrial compostability).
- Shelf-Life 1 year from production date
- Color: off-white, cream-colored appearance
- Smooth inner bag layer to allow for optimal flow
- Not suitable for very heavy or thick masses
- Sterile bag interior
- High tear and puncture resistance
- Carton with removal opening

**72 pcs. / Box**



#	↗ mm	→ mm	μ	
391920	530	280	100	



DE	EINWEG-SPRITZBEUTEL – DOPPELT
EN	DISPOSABLE PASTRY BAGS – DOUBLE
IT	SAC A POCHE USA E GETTA – DOPPIO
ES	MANGAS PASTELERAS DESECHABLES – DOBLE

**Doppelspritzbeutel mit Trenneinlage für zwei verschiedene Massen.**

Material: PE, **doppelt extrudiert.**

- Innenseite glatt
- Gebündelt
- Transparent
- Hygienisch
- Spitze geschlossen
- Ohne Tülle verwendbar
- Hohe Reißfestigkeit der Schweißnaht
- Karton mit Dispenseröffnung

**75 Stk. / Box**

**Double compartment pastry bag with a partition down in the middle, best for using two different ingredients.**

Made of PE, **multiple layers.**

- Silky inner surface for maximum product flow
- Bundle
- Transparent
- Hygienic
- Closed tip
- Can be used without tube for decorating purposes

- Seam with high tensile strength
- Dispenser box

**75 pcs. / Box**

#	↗ mm	→ mm	μ	
<input checked="" type="checkbox"/> 391850	455	305	70	

**i** Passender Adapter + Tüllen auf Seite 227 ff. / Piping tube adapter + decoration tubes on page 227 ff.



DE	EINWEG-SPRITZBEUTEL – “ZIPPER”
EN	DISPOSABLE PASTRY BAGS – “ZIPPER”
IT	SAC A POCHE USA E GETTA – “ZIPPER”
ES	MANGAS PASTELERAS DESECHABLES – “ZIPPER”

Material: CPE

- Hochtransparent
- Mit Skala
- Beschriftungsfeld und Zipper
- Zum Verschließen

**50 Stk. / Box**

Made of CPE

- Crystal clear
- Graduated
- With zip-lock and labelling field
- For locking

**50 pcs. / Box**

#	↗ mm	→ mm	μ	
391050	320	150	50	

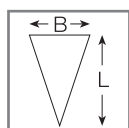

DE	EINWEG-SPRITZBEUTEL – GEBÜNDELT
EN	DISPOSABLE PASTRY BAGS – BUNDLED
IT	SAC A POCHE USA E GETTA – IN BUNDLE
ES	MANGAS PASTELERAS DESECHABLES – EN PAQUETE

Material: PE, **dreifach extrudiert**

- Transparent, hygienisch
- Glatte Innenseite
- Mit Abreißperforation
- Hohe Reißfestigkeit der Schweißnaht
- Spitze geschlossen mit / ohne Tülle verwendbar
- Karton mit Dispenseröffnung

**100 Stk. / Box**

Material: PE, **3-layers**

- Transparent, hygienic
- Smooth inside
- With tear-off perforation
- High tensile strength of the weld seam
- Tip closed usable with / without tube
- Carton with dispenser opening

**100 pcs. / Box**



#	↗ mm	→ mm	μ	
<input checked="" type="checkbox"/> 391400	350	240	75	
<input checked="" type="checkbox"/> 391410	545	300	75	

DE	EINWEG-SPRITZBEUTEL-SET
EN	SET OF DISPOSABLE PASTRY BAGS
IT	SET SAC A POCHES USA E GETTA
ES	JUEGO DE MANGAS DESECHABLES

Set bestehend aus:

- 10 Einweg-Spritzbeuteln (Länge 340 mm),
- 1 Lochtülle, 1 Sternbandtülle, 2 Sterntüllen,
- 1 Verschlussstülle und 1 Verschlussclip
- 10 cm mit Schneidemesser
- Einwegspritzbeutel PE
- Tüllen und Clip aus PP

Set of:

- 10 disposable bags (length 340 mm),
- 1 plain tube, 1 star ribbon tube, 2 star tubes,
- 1 tube fastener, 1 clip 10 cm length with integrated blade
- Pastry bags made of PE
- Tubes and clip made of PP

#		
<input checked="" type="checkbox"/> 350199		



DE	WANDHALTERUNG FÜR EINWEGSPRITZBEUTEL
EN	WALL HOLDER FOR DISPOSABLE PASTRY BAGS
IT	SUPPORTO A PARETE PER SAC À POCHE USA E GETTA
ES	SOPORTE DE PARED PARA MANGAS DESECHABLES

Material: Edelstahl

- Karton mit 100 gerollten Einwegspritzbeuteln (blaue, grüne und orangene Qualitäten) wird seitlich eingeführt
- Größen: 350 mm – 600 mm
- Rückseitige Löcher für Wandmontage
- Schrauben und Dübel sind nicht im Lieferumfang enthalten

Made of stainless steel

- Carton with 100 rolled disposable pastry bags (blue, green and orange designs) to be inserted sideways
- Sizes: 350 mm – 600 mm
- Holes on the back for wall mounting
- Screws and dowels are not included

#	↗ mm	→ mm	↑ mm	
399000	320	115	110	



DE	AIRBRUSH KOMPRESSOR
EN	AIRBRUSH COMPRESSOR
IT	COMPRESSORE PER AEROGRAFO
ES	COMPRESOR PARA AERÓGRAFO

- Automatischer Kompressor mit Filter-/Druckregler und Spiralschlauch
- Tragbar, 3,8 bar
- Gewicht: 5,1 kg
- 45 dBA
- 170 x 280 x 220 mm

- Automatic compressor with filter-/pressure regulator and spiral hose
- Portable, 3,8 bar
- Weight: 5.1 kg
- 45 dBA
- 170 x 280 x 220 mm

#	l. / min.	⚡	🔋	
151420	15,0	115 W	220 V/50 Hz	
151430	Verbindungsschlauch / Connection hose			



DE	AIRBRUSH-PISTOLEN
EN	AIRBRUSHES
IT	PENNE AEROGRAFICHE
ES	AERÓGRAFOS

#		Kapazität/capacity cm <sup>3</sup>	Düse/nozzle mm	
151450	doppelt/double action	2,0	0,2	
151460	doppelt/double action	7,0	0,3	





DE	STERNTÜLLEN
EN	STAR TUBES
IT	BOCCHETTE FORO STELLA, IN UNIPEZZO, INOX
ES	BOQUILLAS ESTRELLA, SIN SOLDADURA

Material: Edelstahl

Made of stainless steel

• Aus einem Stück gezogen

• In one piece



#	Ø mm	Zähne / teeth
197550	2	6
197551	3	6
197552	4	6
197553	5	6
197554	6	6
197555	7	6
197556	8	6
197557	9	6
197558	10	7
197559	11	7
197560	12	7
197561	13	7
197562	14	8
197563	15	8
197564	16	9
197565	17	10
197566	18	10



DE	STERNTÜLLEN-SATZ
EN	SET OF STAR TUBES
IT	SET DI BOCCHETTE FORO STELLA, IN UNIPEZZO, INOX
ES	JUEGO DE BOQUILLAS ESTRELLA, SIN SOLDADURA

Material: Edelstahl

Made of stainless steel

• Aus einem Stück gezogen

• In one piece

#	Ø mm
<input checked="" type="checkbox"/> 197136	Satz 10-teilig / set 10 pcs. – 4, 5, 6, 7, 8, 9, 10, 12, 13, 15



DE	LOCHTÜLLEN
EN	PLAIN TUBES
IT	BOCCHETTE FORO TONDO, IN UNIPEZZO, INOX
ES	BOQUILLAS LISAS, SIN SOLDADURA

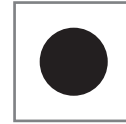

Material: Edelstahl

Made of stainless steel

• Aus einem Stück gezogen

• In one piece

#	Ø mm
197500	2
197501	3
197502	4
197503	5
197504	6
197505	7
197506	8
197507	9
197508	10
197509	11
197510	12
197511	13
197512	14
197513	15
197514	16
197515	17
197516	18
197517	20
197518	22
197519	24



10

DE	LOCHTÜLLEN-SATZ
EN	SET OF PLAIN TUBES
IT	SET DI BOCCHETTE FORO TONDO, IN UNIPEZZO, INOX
ES	JUEGO DE BOQUILLAS LISAS, SIN SOLDADURA



Material: Edelstahl

Made of stainless steel

• Aus einem Stück gezogen

• In one piece

#	Ø mm
<input checked="" type="checkbox"/> 197180	Satz 10-teilig / set 10 pcs. – 4, 5, 6, 7, 8, 9, 10, 12, 13, 15





DE	STERNTÜLLEN (FRANZÖSISCHE TÜLLEN)
EN	FRENCH STAR TUBES
IT	BOCCHETTE STELLA FRANCESE, IN UNIPEZZO, INOX
ES	BOQUILLAS ESTRELLA FRANCESA, SIN SOLDADURA

Material: Edelstahl

Made of stainless steel

• Aus einem Stück gezogen

• In one piece



#	Ø mm	Zähne / teeth
197335	4	9
197310	5	9
197311	6	9
197312	7	10
197313	8	12
197336	9	12
197314	10	14
197333	11	14
197315	12	15
197316	13	15
197317	14	16
197337	15	15
197318	16	17
197319	18	18

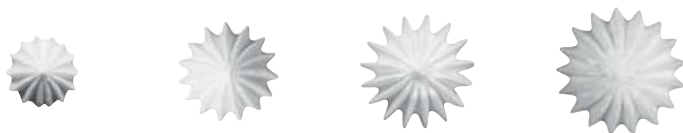

DE	STERNTÜLLEN, GESCHLOSSEN
EN	CLOSED STAR TUBES
IT	BOCCHETTE STELLA CHIUSA, IN UNIPEZZO, INOX
ES	BOQUILLAS ESTRELLA CERRADA, SIN SOLDADURA

Material: Edelstahl

Made of stainless steel

• Aus einem Stück gezogen

• In one piece



#	Ø mm	Zähne / teeth
197320	2	6
197321	3	6
197322	4	6
197323	5	6
197324	6	6
197325	7	6
197326	8	7
197327	9	7
197328	10	8
197329	11	9
197334	12	10





DE	STERNBANDTÜLLEN
EN	STAR RIBBON TUBES
IT	BOCCHETTE DELIZIA, IN UNIPEZZO, INOX
ES	BOQUILLAS "CINTA ESTRIADA", SIN SOLDADURA

Material: Edelstahl

Made of stainless steel

• Aus einem Stück gezogen

• In one piece



#	Öffnungsgröße / opening size (mm)
197300	16 x 2
197301	20 x 3
197302	28 x 4



DE	ROSENTÜLLEN
EN	ROSE TUBES
IT	BOCCHETTE "ROSA", IN UNIPEZZO, INOX
ES	BOQUILLAS "ROSA", SIN SOLDADURA

Material: Edelstahl

Made of stainless steel

• Aus einem Stück gezogen

• In one piece



#	Ø mm
197330	5
197331	6
197332	8



10

DE	BERLINER TÜLLE
EN	FRITTER TUBE
IT	BOCCHETTA AD IMBUTINO
ES	BOQUILLA ESPECIAL PARA RELLENAR

Material: Edelstahl

Made of stainless steel

• Verschweißt

• Welded seam

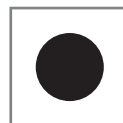

#	↑ mm	Ø mm
197340	95	4





DE	VERGISSMEINNICHT
EN	FORGET-ME-NOT
IT	NONTISCORDARDIMÉ
ES	NOMEOLVIDES

#	197400
Ø mm	4,5
↑ mm	39



DE	ROSENAUSDREHER
EN	ROSE SCREW
IT	ROSA OBLIQUA
ES	ROSA INCLINADA

#	197401
Ø mm	6,0
↑ mm	41



DE	LOCH
EN	HOLE
IT	FORO
ES	AGUJERO

#	197402
Ø mm	5,0
↑ mm	48



DE	BLÜTENBLATT KLEIN
EN	PETAL SMALL
IT	PETALO PICCOLO
ES	PÉTALO PEQUEÑO

#	197405
↔ mm	3,6 x 16
↑ mm	41



DE	BLÜTENBLATT MITTEL
EN	PETAL MEDIUM
IT	PETALO MEDIO
ES	PÉTALO MEDIO

#	197406
↔ mm	5,4 x 25
↑ mm	44



DE	BLÜTENBLATT GROSS
EN	PETAL LARGE
IT	PETALO GRANDE
ES	PÉTALO GRANDE

#	197407
↔ mm	3 x 15
↑ mm	53



DE	BLATTTÜLLE MINI
EN	LEAF MINI
IT	FOGLIO MINI
ES	HOJA MINI

#	197408
Ø mm	2,7
↑ mm	41



DE	BLATTTÜLLE MITTEL
EN	LEAF MEDIUM
IT	FOGLIO MEDIO
ES	HOJA MEDIA

#	197410
Ø mm	4,8
↑ mm	42



DE	BLATTTÜLLE GROSS
EN	LEAF LARGE
IT	FOGLIO GRANDE
ES	HOJA GRANDE

#	197411
Ø mm	4,6
↑ mm	52



DE	GARNIERTÜLLE
EN	GARNISHING TUBE
IT	BOCCHETTA DECORATRICE
ES	BOQUILLA PARA DECORACIÓN

#	197412
Ø mm	2,4
↑ mm	52



DE	GARNIERTÜLLE
EN	GARNISHING TUBE
IT	BOCCHETTA DECORATRICE
ES	BOQUILLA PARA DECORACIÓN

#	197413
Ø mm	6,0
↑ mm	47



DE	GARNIERTÜLLE
EN	GARNISHING TUBE
IT	BOCCHETTA DECORATRICE
ES	BOQUILLA PARA DECORACIÓN

#	197414
Ø mm	1,5
↑ mm	47



DE	GARNIERTÜLLE
EN	GARNISHING TUBE
IT	BOCCHETTA DECORATRICE
ES	BOQUILLA PARA DECORACIÓN

#	197415
Ø mm	6,0
↑ mm	52



DE	GARNIERTÜLLE
EN	GARNISHING TUBE
IT	BOCCHETTA DECORATRICE
ES	BOQUILLA PARA DECORACIÓN

#	197417
Ø mm	9,3
↑ mm	52



DE	STERNBANDTÜLLE OFFEN
EN	STAR RIBBON TUBE OPEN
IT	BOCCHETTA DELIZIA APERTA
ES	BOQUILLA CINTA ESTRIADA ABIERTA

#	197418
↔ mm	3,75 x 18
↑ mm	51,5



DE	DREILOCHTÜLLE
EN	THREE HOLES TUBE
IT	BOCCHETTA A TRE FORI
ES	BOQUILLAS CON TRES HOYOS

#	197420
Ø mm	3,0
↑ mm	50



DE	VERMICELLE KLEIN
EN	BIRD NEST TUBE SMALL
IT	VERMICELLI, PICCOLA
ES	VERMICELLI, PEQUEÑA

#	197421
Ø mm	1,0
↑ mm	38



DE	VERMICELLE GROSS
EN	BIRD NEST TUBE LARGE
IT	VERMICELLI, GRANDE
ES	VERMICELLI, GRANDE

#	197422
Ø mm	2,9
↑ mm	37



DE	VERMICELLE KLEIN
EN	BIRD NEST TUBE SMALL
IT	VERMICELLI, PICCOLA
ES	VERMICELLI, PEQUEÑA

#	197423
Ø mm	2,0
↑ mm	45



DE	VERMICELLE GROSS
EN	BIRD NEST TUBE LARGE
IT	VERMICELLI, GRANDE
ES	VERMICELLI, GRANDE

#	197424
Ø mm	4,5
↑ mm	45



DE	ST. HONORÉ
EN	ST. HONORÉ
IT	ST. HONORÉ
ES	ST. HONORÉ

#	197425
Ø mm	12
↑ mm	41



DE	ST. HONORÉ
EN	ST. HONORÉ
IT	ST. HONORÉ
ES	ST. HONORÉ

#	197426
Ø mm	14
↑ mm	39



DE	ST. HONORÉ
EN	ST. HONORÉ
IT	ST. HONORÉ
ES	ST. HONORÉ

#	197427
Ø mm	15
↑ mm	46



DE	ST. HONORÉ
EN	ST. HONORÉ
IT	ST. HONORÉ
ES	ST. HONORÉ

#	197403
↔ mm	11 x 21
↑ mm	53



DE	GARNIERTÜLLE
EN	GARNISHING TUBE
IT	BOCCHETTA DECORATRICE
ES	BOQUILLA PARA DECORACIÓN

#	197428
Ø mm	11
↑ mm	51



DE	GARNIERTÜLLE
EN	GARNISHING TUBE
IT	BOCCHETTA DECORATRICE
ES	BOQUILLA PARA DECORACIÓN

#	197429
Ø mm	13
↑ mm	48



DE	GARNIERTÜLLE
EN	GARNISHING TUBE
IT	BOCCHETTA DECORATRICE
ES	BOQUILLA PARA DECORACIÓN

#	197430
Ø mm	15
↑ mm	52



DE	STERNBANDTÜLLE
EN	STAR RIBBON TUBE
IT	BOCCHETTA DELIZIA
ES	BOQUILLA PARA DECORACIÓN

#	197303
Ø mm	19
↑ mm	52



DE	MAGNOLIE
EN	MAGNOLIA
IT	MAGNOLIA
ES	MAGNOLIA

#	197570
Ø mm	25
↑ mm	42



DE	TULPE
EN	TULIP
IT	TULIPANO
ES	TULIPÁN

#	197571
Ø mm	23
↑ mm	42



DE	ROSE
EN	ROSE
IT	ROSA
ES	ROSA

#	197572
Ø mm	25
↑ mm	42



DE	TULPE
EN	TULIP
IT	TULIPANO
ES	TULIPÁN

#	197573
Ø mm	23
↑ mm	42



DE	NARZISSE
EN	DAFFODIL
IT	NARCISO
ES	NARCISO

#	197574
Ø mm	25
↑ mm	42



DE	TULPE
EN	TULIP
IT	TULIPANO
ES	TULIPÁN

#	197575
Ø mm	25
↑ mm	42



DE	TULPE
EN	TULIP
IT	TULIPANO
ES	TULIPÁN

#	197576
Ø mm	25
↑ mm	42



DE	TULPE
EN	TULIP
IT	TULIPANO
ES	TULIPÁN

#	197577
Ø mm	25
↑ mm	42



DE	BLÜMCHEN
EN	FLOWER
IT	FIORELLINO
ES	FLORCITA

#	197578
Ø mm	25
↑ mm	42



DE	BLÜMCHEN
EN	FLOWER
IT	FIORELLINO
ES	FLORCITA

#	197579
Ø mm	25
↑ mm	42



DE	BLÜMCHEN
EN	FLOWER
IT	FIORELLINO
ES	FLORCITA

#	197580
Ø mm	25
↑ mm	42



DE	BLÜMCHEN
EN	FLOWER
IT	FIORELLINO
ES	FLORCITA

#	197581
Ø mm	25
↑ mm	42



DE	BLÜMCHEN
EN	FLOWER
IT	FIORELLINO
ES	FLORCITA

#	197582
Ø mm	25
↑ mm	42



DE	BLÜMCHEN
EN	FLOWER
IT	FIORELLINO
ES	FLORCITA

#	197583
Ø mm	25
↑ mm	42



DE	BLÜMCHEN
EN	FLOWER
IT	FIORELLINO
ES	FLORCITA

#	197584
Ø mm	25
↑ mm	42

DE	SPRITZTÜLLEN-SET
EN	SET OF DECORATING TUBES
IT	SET BOCCHETTE, INOX
ES	CAJA SURTIDA DE BOQUILLAS

- Material: Edelstahl
- Inklusive Adapter
  - Box aus stabilem Kunststoff

- Made of stainless steel
- With adapter
  - Box made of sturdy plastic

#	Teile / pieces	↑ mm
197032	55	30
197033	29	30
197060	38	50



DE	TÜLLENBÜRSTE
EN	BRUSH FOR TUBES
IT	BRUSCHINO PER BOCCHETTE
ES	CEPILLO PARA LIMPIAR BOQUILLAS

- Griff aus PP, mit Aufhängeöse
- Borsten aus Nylon
- Für alle Tüllen verwendbar

- Grip made of PP, with hole
- Bristles made of nylon
- Useable for all tubes

#	↗ mm
200245	180



10

DE	TÜLLEN-ADAPTER
EN	EXTERNAL PIPING TUBE ADAPTER
IT	ADATTATORE PER BOCCHETTE
ES	ADAPTADOR PARA BOQUILLAS

- Material: PP, weiß
- 2-teilig
  - Schraubverschluss

- PP, white
- 2 pieces
  - With screw top

#	↑ mm
197595	77



**Bsp.: Für nahezu alle Tüllen verwendbar! Can be used for nearly all nozzles!**





DE	TÜLLEN-ADAPTER - <b>DOPPELT</b>		
EN	EXTERNAL PIPING TUBE ADAPTER - <b>DOUBLE</b>		
IT	ADATTATORE PER BOCCHETTE - <b>DOPPIO</b>		
ES	ADAPTADOR PARA BOQUILLAS - <b>DOBLE</b>		

- |  |   |
|--|---|
| Material: BPA-frei, Farbe glasklar     | BPA-free, color: crystal clear            |
| • 3-teilig                             | • 3 pieces                                |
| • Spülmaschinengeeignet                | • Dishwasher safe                         |
| • Für Einwegspritzbeutel 50 µ bis 75 µ | • For disposable pastry bags 50 µ to 75 µ |

#	Ø mm	↑ mm	
<input checked="" type="checkbox"/> 196660	48	63	



**i** Mit allen "Multi-Deko"-Tüllen verwendbar. / Can be used with all "Multi-Deko" tubes. / Utilizzabile con tutte le bocchette "Multi-Deko". / Se puede usar con todas las boquillas "Multi-Deko".



Adapter mit Tülle zum Aufstecken / twist-on adapter



Adapter mit Verschluss-Kappe / adapter with cap



DE	TÜLLENKASSETTEN-SET "MULTI-DEKO"		
EN	INTERCHANGABLE PIPING TUBES SET "MULTI-DEKO"		
IT	SET BOCCHETTE ASSORTITE "MULTI-DEKO"		
ES	SURTIDO BOQUILLAS "MULTI-DEKO"		

- |   |   |
|---|---|
| Material: PC – BPA-frei, Farbe glasklar     | Made of PC – BPA-free, color: crystal clear |
| • Höhe: ca. 3,0 – 5,0 cm                    | • Height: 3.0 – 3.5 cm                      |
| • Wandmontage möglich                       | • Wall fastening possible                   |
| • Inkl. Deckel für hygienische Aufbewahrung | • Incl. lid for hygienic storage            |
| • Spülmaschinengeeignet                     | • Dishwasher safe                           |

#		Ø mm	
<input checked="" type="checkbox"/> 196600	8 Lochtüllen, 2 Adapter, 2 Verschlüsse, 1 Tüllenbürste / 8 plain tubes, 2 adapters, 2 caps, 1 brush	1, 2, 3, 5, 7, 9, 13, 15	
<input checked="" type="checkbox"/> 196610	8 Sterntüllen, 2 Adapter, 2 Verschlüsse, 1 Tüllenbürste / 8 star tubes, 2 adapters, 2 caps, 1 brush	4, 5, 7, 9 (6 Zähne/points) 7, 9, 11, 13 (8 Zähne/points)	
<input checked="" type="checkbox"/> 196620	8 Dekortüllen, 1 Berliner Tülle, 2 Adapter, 2 Verschlüsse / 8 decorating tubes, 1 fritter tube, 2 adapters, 2 caps		
<input checked="" type="checkbox"/> 196630	8 franz. Sterntüllen, 2 Adapter, 2 Verschlüsse, 1 Tüllenbürste / 8 french star tubes, 2 adapters, 2 caps, 1 brush	4,5 / 5,5 / 6 / 7,5 / 8 / 8 / 9 / 10	

**i** scharfe Konturen für perfektes Dekorieren / sharp contours for perfect decorating





# 196600

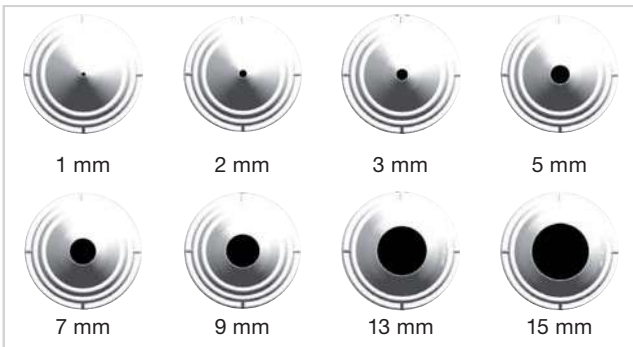

# 196610

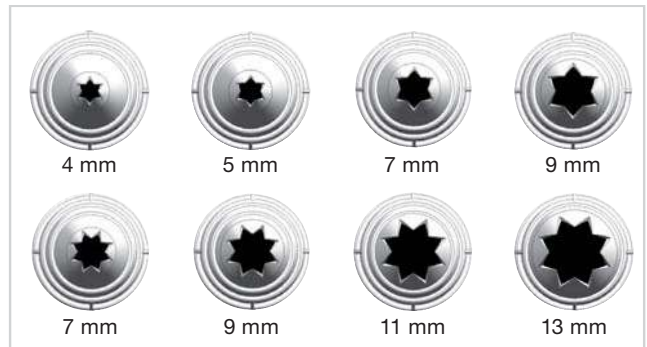

# 196620

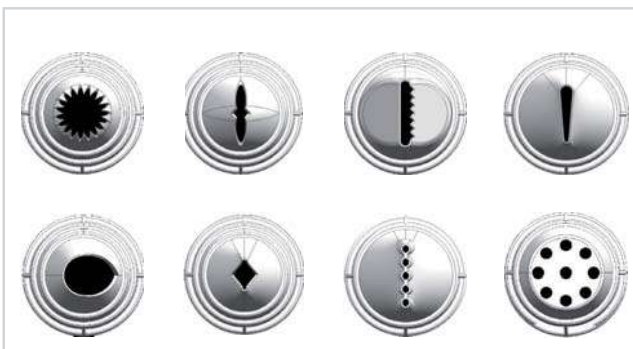

# 196630



10





DE	STERNTÜLLEN
EN	STAR TUBES
IT	BOCCHETTE FORO STELLA
ES	BOQUILLAS ESTRELLA

Material: PP, Farbe elfenbein  
 • Höhe: 6 cm

Made of PP, color ivory  
 • Height: 6 cm



#	Ø mm
196500	3
196501	5
196502	7
196503	9
196504	11
196505	13
196506	15
196507	17



DE	LOCHTÜLLEN
EN	PLAIN TUBES
IT	BOCCHETTE FORO TONDO
ES	BOQUILLAS LISAS

Material: PP, Farbe elfenbein  
 • Höhe: 6 cm

Made of PP, color ivory  
 • Height: 6 cm



#	Ø mm
196520	5
196521	7
196522	9
196523	11
196524	13
196525	15
196526	17
196527	19
196528	26

# 196530



DE	TÜLLEN-SET
EN	PIPING TUBE SET
IT	SET DI BOCCHETTE
ES	JUEGO DE BOQUILLAS

Material: PP, Farbe elfenbein  
 • Höhe: 6 cm  
 • 6 verschiedene Tüllen

Made of PP, color ivory  
 • Height: 6 cm  
 • 6 different tubes

#	Ø mm
196530	3, 5, 7, 9, 11, 13
196540	5, 7, 9, 11, 13, 15

# 196540



DE	TÜLLENKASSETTEN-SET
EN	ASSORTED PIPING TUBE SET
IT	SCATOLA DI BOCCHETTE ASSORTITE
ES	CAJA DE BOQUILLAS SURTIDAS

Material: PP, Farbe elfenbein

• Höhe: 6 cm

• **12 verschiedene Tüllen**

Made of PP, color ivory

• Height: 6 cm

• **12 different tubes**

#		Ø (ca. mm)	
196550	4 Sterntüllen, 4 Lochtüllen, 4 Garniertüllen / 4 star tubes, 4 plain tubes, 4 decorating tubes	5, 7, 9, 11 5, 7, 9, 11 Grattülle, Rosentülle, Stern- bandtülle links und rechts / ribbon, rose, star ribbon tip, left and right	
196560	4 Sterntüllen, 4 Lochtüllen, 4 Garniertüllen / 4 star tubes, 4 plain tubes, 4 decorating tubes	11, 13, 15, 17 13, 15, 17, 19 Blatt-, Doppelloch-, Rosen- und Riefentülle / Leaf, double hole, rose and flute tip	

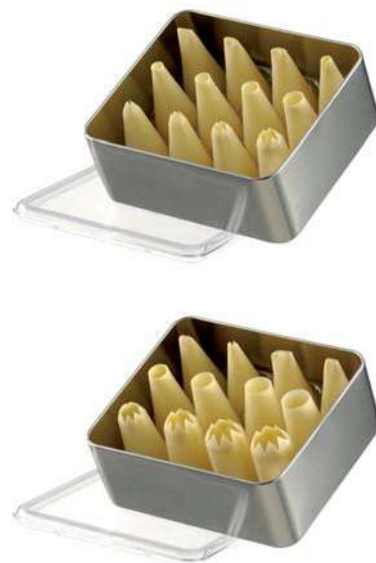

Material: PP, Farbe elfenbein

• Höhe: ca. 3,0 – 3,5 cm

• **20 verschiedene Tüllen**

• **2 Adapter (2-tlg.)**

Made of PP, color ivory

• Height: 3.0 – 3.5 cm

• **20 different tubes**

• **2 adapters (2 pcs.)**

#		Ø (ca. mm)	
196570	4 Sterntüllen, 8 Lochtüllen, 8 Garniertüllen, 2 Adapter (2-tlg.) / 4 star tubes, 8 plain tubes, 8 decorating tubes, 2 adapters (2 pcs.)	5, 7, 11, 13 5 – 13	
196580	8 Sterntüllen, 4 Lochtüllen, 8 Garniertüllen, 2 Adapter (2-tlg.) / 8 star tubes, 4 plain tubes, 8 decorating tubes, 2 adapters (2 pcs.)	3 – 17 5, 7, 9, 13	



10



DE	EISSPACHTELN
EN	ICE CREAM SPATULAS
IT	SPATOLE PER GELATO
ES	CUCHARAS PARA HELADO

Material: Edelstahl  
 • Griff aus Kunststoff

Made of stainless steel  
 • With plastic handle

#	↗ mm		
195210	260	rot transparent / red transparent	
195220	260	blau transparent / blue transparent	
195230	260	gelb transparent / yellow transparent	
195250	260	schwarz transparent / black transparent	
195260	260	transparent / transparent	
195290	260	100% Kunststoff / 100% plastic	
195100	260	● blau / blue	
195110	300	● blau / blue	
195120	260	● rot / red	
195130	300	● rot / red	
195140	260	● gelb / yellow	
195150	300	● gelb / yellow	
195180	260	● rosa / pink	
195190	300	● rosa / pink	



© stockcreations - stock.adobe.com

DE	EISDIPPER	
EN	ICE CREAM DIPPERS	ALU
IT	SPATOLE PER GELATO	
ES	RACIONADORES HELADO COMPACTOS	

Material: Aluminium, wärmeleitende Flüssigkeit im Griff

Made of aluminum, with heat conductive fluid inside handle

#	 l	Ø mm
<input checked="" type="checkbox"/> 190210	1/16	61
<input checked="" type="checkbox"/> 190220	1/20	57
<input checked="" type="checkbox"/> 190230	1/24	51
<input checked="" type="checkbox"/> 190240	1/30	45



DE	EISPORTIONIERER	
EN	ICE CREAM SCOOPS	CNS
IT	PORZIONATORI PER GELATO	
ES	RACIONADORES HELADO	

**Material: Edelstahl**

- Ergonomischer Griff aus Kunststoff
- Anwendung: für Eis, Früchte, Reis, Mousse und andere Speisen

**Made of stainless steel**

- With ergonomic plastic handle
- Usable for ice cream, fruits, rice, mousse and other food

#	 l	Ø mm
<input checked="" type="checkbox"/> 195010	1/8	79
<input checked="" type="checkbox"/> 195015	1/12	65
<input checked="" type="checkbox"/> 195020	1/16	61
<input checked="" type="checkbox"/> 195025	1/20	56
<input checked="" type="checkbox"/> 195030	1/24	51
<input checked="" type="checkbox"/> 195035	1/30	49
<input checked="" type="checkbox"/> 195040	1/36	46
<input checked="" type="checkbox"/> 195045	1/40	44
<input checked="" type="checkbox"/> 195050	1/50	42
<input checked="" type="checkbox"/> 195055	1/60	39
<input checked="" type="checkbox"/> 195060	1/100	28



**Material: Edelstahl**

- Schwere Profi-Qualität

**Made of stainless steel**

- Heavy quality for professionals

#	 l	Ø mm
195400	1/8	80
195405	1/12	67
195410	1/16	59
195415	1/20	56
195420	1/24	53
195425	1/30	50
195430	1/36	48
195435	1/40	44
195440	1/50	40



**Material: Edelstahl**

- Schwere Profi-Qualität
- „OVAL“

**Made of stainless steel**

- Heavy quality for professionals
- “OVAL”

#	 l	↔ mm
195450	1/30	58 x 46



DE	EISBEHÄLTER / EISSCHALEN
EN	ICE CREAM CONTAINERS
IT	BACINELLE PER GELATO
ES	CUBETAS HELADO

Material: Edelstahl  
 • Für Eisvitrinen

Made of stainless steel  
 • For ice cream cabinets



#	↗ mm	→ mm	↑ mm	♻️ l	
199616	360	165	80	3,25	
199610	360	165	120	4,9	
199611	360	165	150	6,3	
199612	360	165	180	7,3	
199615	360	250	80	5,6	
199614	360	250	120	8,7	
199617	360	250	150	11,2	
199618	360	250	180	12,9	
199619	330	165	80	3,3	
199622	330	165	120	5,0	
199623	330	165	150	6,2	
199624	330	165	180	7,6	
199613	265	160	170	5,0	



Material: PC  
 • Unzerbrechlich

Made of PC  
 • Unbreakable

#	↗ mm	→ mm	↑ mm	♻️ l	
199620	360	165	120	4,8	
199621	360	250	80	5,3	

DE	DECKEL FÜR EISBEHÄLTER
EN	LID FOR ICE CREAM CONTAINERS
IT	COPERCHIO PER BACINELLE PER GELATO
ES	TAPA PARA CUBETAS HELADO

Material: PC  
 • Unzerbrechlich

Made of PC  
 • Unbreakable



#	↗ mm	→ mm	↑ mm	für / for	
199625	360	250	82	199614, 199615, 199617, 199618	
199626	330	165	18	199619, 199622, 199623, 199624	
199629	260	160	18	199613	
199630	360	165	18	199610, 199611, 199612, 199616, 199620	

DE	SCHABER EDELSTAHL
EN	SCRAPERS STAINLESS STEEL
IT	RASCHIETTI, INOX
ES	RASQUETAS, INOX

Material: Edelstahl

Made of stainless steel

#	↔ mm		
154840	100 x 100	Quadrat / square	
154841	110 x 110	Dreieck / triangular	
154842	110 x 75	Rechteck / rectangular	

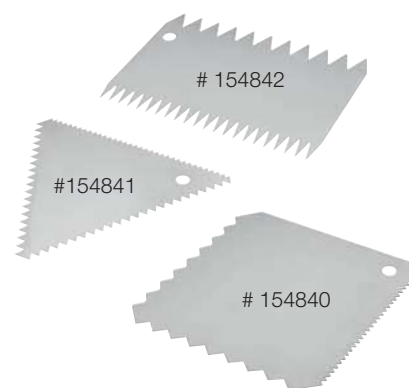

DE	SERVIERTABLETTS OVAL
EN	SERVING TRAYS OVAL
IT	VASSOI DA PORTATA OVALI
ES	BANDEJAS OVALADAS

Material: Edelstahl

Made of stainless steel

- Mit gebördeltem Rand
- **Oberfläche matt**

- With rolled edge
- **Matte finish**

#	↔ mm		
155040	145 x 200		
155041	180 x 230		
155042	195 x 265		
155043	220 x 285		



DE	SERVIETTENSPENDER / SERVIETTENHALTER
EN	NAPKIN HOLDERS
IT	PORTATOVAGLIOLI
ES	SERVILLETERO

Material: Edelstahl

Made of stainless steel

- Für 100 Servietten:
- 170 x 170 mm (Maße Serviette entfalten)
- 85 x 115 mm (Maße Serviette gefalten)

- For 100 napkins:
- 170 x 170 mm (dimensions napkin unfolded)
- 85 x 115 mm (dimensions napkin folded)

#	→ mm	↓ mm	↑ mm	
195700	95	100	130	



11

DE	LÖFFELFLÖTE / LÖFFELBEHÄLTER
EN	SPOON HOLDER
IT	PORTA CUCCHIAINI
ES	PORTA CUCHARILLA

Material: Acryl

Made of acrylic

- Inklusive Distanzeinlage
- Mit 3 quadratischen Löffelboxen

- Including distance spacer
- With 3 square boxes

#	→ mm	↓ mm	↑ mm	
172300	225	150	150	





© stockcreations - stock.adobe.com



# 172200



# 172201



# 172202



# 172203



# 172204

DE	EISWAFFELHALTER / HÖRNCHENSTÄNDER "SILO"
EN	ICE CREAM CONE HOLDER "SILO"
IT	PORTA CONI "SILO"
ES	PORTA CONOS DE HELADO "SILO"

Material: Acryl

Made of acrylic

#		Ø mm	↗ mm	→ mm	↑ mm
172200	1 Loch, inkl. Schublade / 1 hole, with drawer	45	120	105	500
172201	5 Loch, inkl. Schublade / 5 holes, with drawer	4 x 24 / 1 x 30	140	140	500
172202	13 Loch, inkl. Schublade / 13 holes, with drawer	9 x 24 / 4 x 30	205	205	500
172203	18 Loch / 18 holes	12 x 24 / 6 x 30	240	180	590
172204	18 Loch / 18 holes	12 x 24 / 6 x 30	240	185	550



© stockcreations - stock.adobe.com



DE	EISTÜTENHALTER
EN	ICE CREAM CONE HOLDERS
IT	PORTA CONI
ES	PORTA CONOS DE HELADO

Material: Edelstahl  
 • Mit Antirutsch-Füßchen

Made of stainless steel  
 • With non-slip feet

**Für 3 Eistüten**

**For 3 cones**

#	Ø mm	→ mm	↓ mm	↑ mm
190300	26	200	95	85

**Für 4 Eistüten**

**For 4 cones**

#	Ø mm	→ mm	↓ mm	↑ mm
190305	26	270	95	85

**Für 4 Eistüten, "MAXI"**

**For 4 cones, "MAXI"**

#	Ø mm	→ mm	↓ mm	↑ mm
190308	2 x 26/2 x 31	270	95	85

Material: Acryl  
**Für 3 Eistüten**

Made of acrylic  
**For 3 cones**

#	Ø mm	→ mm	↓ mm	↑ mm
172100	34	185	90	95

**Für 4 Eistüten**

**For 4 cones**

#	Ø mm	→ mm	↓ mm	↑ mm
172101	34	250	90	95

Material: Edelstahl  
**Für 4 Eistüten**

Made of stainless steel  
**For 4 cones**

#	Ø mm	↑ mm
190310	165	140





© Igor Normann - stock.adobe.com



DE	SCHOKOLADEN-FONTÄNE
EN	CHOCOLATE FOUNTAIN
IT	FONTANA DI CIOCCOLATO
ES	FUENTE DE CHOCOLATE

- |                                     |                                     |
|-------------------------------------|-------------------------------------|
| Material: Edelstahl                 | Made of stainless steel             |
| • Temperatur einstellbar: 0 – 80 °C | • Temperature adjustable: 0 – 80 °C |
| • Bodendurchmesser: 33 cm           | • Bottom diameter: 33 cm            |
| • Spannung: 240 V, 50/60 HZ         | • Voltage: 240 V, 50/60 HZ          |

#	↑ mm	⬇ kg	⚡ W
255320	600	5 kg	150 W

- |                                     |                                     |
|-------------------------------------|-------------------------------------|
| Material: Edelstahl                 | Made of stainless steel             |
| • Temperatur einstellbar: 0 – 80 °C | • Temperature adjustable: 0 – 80 °C |
| • Spannung: 240 V, 50/60 HZ         | • Voltage: 240 V, 50/60 HZ          |

#	↑ mm	⬇ kg	⚡ W
255350	800	8	215 W

DE	REINIGUNGSBÜRSTE	<b>NEW</b>
EN	CLEANING BRUSH	
IT	SPAZZOLA PER PULIZIA	
ES	CEPILLO LIMPIADOR	

- |  |   |
|--|---|
| Material: Verzinkter Draht,<br>Borsten Nylon | Made of galvanised wire, bristles nylon |
|--|---|

#	↔ mm
120655	700 x 120 x 55



DE	DOSIERGERÄT "PRALINENFIX D"	
EN	DOSING METER "PRALINENFIX D"	
IT	DOSATRICE PER CIOCCOLATINI "PRALINENFIX D"	
ES	DOSIFICADOR PARA RELLENAR BOMBONES "PRALINENFIX D"	

Material: Edelstahl

- Speziell für flüssige Massen wie Schokolade, Kuvertüre, Ganache, Nougat etc.
- Zum schnellen, exakten und gleichmäßigen Füllen von Hohlkugeln
- Dosierung erfolgt stufenlos Reihe für Reihe mit Hilfe von 7 verstellbaren Tüllen
- Über 100 Füllungen pro Minute
- Beheizte Kolbeneinheiten
- Einfache Reinigung und Handhabung

Made of stainless steel

- Especially for liquid masses like chocolate, couverture, ganache, nougat etc.
- For fast, precise and equal filling of hollow shells
- Dosing is done steplessly row by row with the help of 7 adjustable nozzles
- More than 100 fillings per minute
- Heated piston units
- Easy cleaning and handling



#	↔ mm	⚖ kg	⚡	🔌
450500	510 x 400 x 570	17	10 W	230 V / 50 Hz

DE	DOSIERGERÄT "PRALINENFIX B"	
EN	DOSING METER "PRALINENFIX B"	
IT	DOSATRICE PER CIOCCOLATINI "PRALINENFIX B"	
ES	DOSIFICADOR PARA RELLENAR BOMBONES "PRALINENFIX B"	

Material: Edelstahl

- Speziell für Formen von **Chocolate World**
- Speziell für flüssige Massen wie Schokolade, Kuvertüre, Ganache, Nougat etc.
- Zum schnellen, exakten und gleichmäßigen Füllen von Pralinenformen
- Dosierung erfolgt stufenlos Reihe für Reihe mit Hilfe von 8 verstellbaren Tüllen
- Über 100 Füllungen pro Minute
- Beheizte Kolbeneinheiten
- Einfache Reinigung und Handhabung

Made of stainless steel

- Especially for moulds from **Chocolate World**
- Especially for liquid masses like chocolate, couverture, ganache, nougat etc.
- For fast, precise and equal filling of chocolate moulds
- Dosing is done steplessly row by row with the help of 8 adjustable nozzles
- More than 100 fillings per minute
- Heated piston units
- Easy cleaning and handling

#	↔ mm	⚖ kg	⚡	🔌
450510	510 x 400 x 570	17	10 W	230 V / 50 Hz



12

DE	ZUBEHÖR: LIKÖRTÜLLE
EN	EQUIPMENT: LIQUEUR TUBE
IT	ACCESSORIO PER FARCIRE PRALINE AL LIQUORE
ES	ACCESORIO PARA RELLENAR BOMBONES DE LICOR

#	
450520	



Geeignet zum Schneiden und Einteilen von Schokolade, Pralinen, Marzipan, Fruchtgelee, Gebäck, etc.  
 Suitable for cutting and dividing chocolate, pralines, marzipan, fruit jelly, pastries, etc.



**NEW**

DE	PRALINENSCHNEIDER GITARRE	<b>SST</b>
EN	PRALINE CUTTER GUITAR	
IT	CHITARRA TAGLIERINA PER CIOCCOLATO	
ES	GUITARRA CORTADOR DE CHOCOLATE	

- Inklusive 3 Rahmen
  - Schnittgrößen: 15, 22,5, 30 mm
  - Schneidetisch: 410 x 380 mm
  - Inklusive Wendepatte: 370 x 400 mm
  - Inklusive 10 Ersatzdrähten
  - Inklusive Werkzeug
- Including 3 frames
  - Cutting sizes: 15, 22,5, 30 mm
  - Cutting table: 410 x 380 mm
  - Including turning plate: 370 x 400 mm
  - Including 10 spare wires
  - Including tool

#	↗ mm	→ mm	↑ mm	⚖ kg
255010	700	480	110	20,5





DE	PRALINENSCHNEIDER GITARRE	<b>SST</b>
EN	PRALINE CUTTER GUITAR	
IT	CHITARRA TAGLIERINA PER CIOCCOLATO	
ES	GUITARRA CORTADOR DE CHOCOLATE	

- Inklusive 3 Rahmen
  - Schnittgrößen: 10, 20, 30 mm
  - Schneidetisch: 310 x 310 mm
- Including 3 frames
  - Cutting sizes: 10, 20, 30 mm
  - Cutting table: 310 x 310 mm



#	↗ mm	→ mm	↑ mm	⚖ kg
255000	600	340	128	23,0

DE	SCHOKOLADEN TEMPERIERGERÄT	
EN	CHOCOLATE MELTER	SST
IT	TEMPERATRICE DI CIOCCOLATO	
ES	TEMPERADOR DE CHOCOLATE	

- Speziell für Schokolade
  - Gehäuse, Behälter und Deckel aus Edelstahl
  - Digitales Touchbedienfeld
  - Inklusive Temperaturfühler
  - **Achtung: Wasserbad-Funktion**
- Especially for chocolate
  - Housing, container and lid made of stainless steel
  - Digital touch control panel
  - Temperature probe included
  - **Attention: Bain-Marie Function**

#	255800	255850	255860
Behälter (Tiefe) / Container (Depth)	<b>GN 1/2</b> – 100 mm	<b>GN 1/1</b> – 100 mm	<b>GN 1/1</b> – 150 mm
Volumen / Volume (l.)	6,0	13,0	17,0
für Schokolade / for chocolate (kg)	5,0	12,0	15,0
↔ mm	440 x 340 x 200	700 x 390 x 200	700 x 390 x 250
	800 W / 50 – 60 Hz 220 – 240 V	1200 W / 50 – 60 Hz 220 – 240 V	1200 W / 50 – 60 Hz 220 – 240 V
 kg	8,0	12,0	13,8
°C	0° – 50°C	0° – 50°C	0° – 50°C



DE	SCHOKOLADENSPENDER	
EN	CHOCOLATE DISPENSER	SST PP  
IT	DISPENSER DI CIOCCOLATO	
ES	DISPENSADOR DE CHOCOLATE	

- Garantiert ein kontinuierliches Rühren und Verteilen der Schokolade
  - Passend für # 255860 (GN 1/1, 150 mm)
- Guarantees continuous stirring and distribution of the chocolate
  - Suitable for # 255860 (GN 1/1, 150 mm)

#	255880
↔ mm	490 x 410 x 340
	120 W
	230 V 50 – 60 HZ
	42 U / min 42 rpm
 kg	7,65

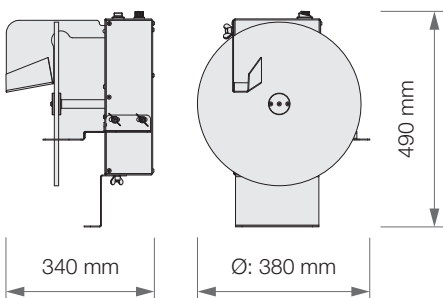



DE	PRALINENTUNKGABEL-SET
EN	DIPPING FORK SET
IT	SET FORCHETTINE PRALINERIA, INOX
ES	JUEGO DE PARA BOMBONES DE CHOCOLATE

- |   |  |
|---|--|
| Material: Edelstahl<br>• Griff: Kunststoff (ABS), schwarz<br>• Inklusive Kunststoffkoffer<br>(L x B x H: 240 x 195 x 45 mm) | Made of stainless steel<br>• Handle: plastic, black (ABS)<br>• With plastic storage case<br>(L x W x H: 240 x 195 x 45 mm) |
|---|--|

Set bestehend aus:  
je 1 Stück rund (14, 16, 18, 20 mm),  
Dreieck, Spirale, Tropfen, 2-, 3-, 4-zinkig

Set consisting of 1 fork each:  
round (dia. 14, 16, 18, 20 mm) triangle,  
spiral and drop, 2, 3 and 4 points

#		
199033	10-teilig / 10 pieces	



DE	PRALINENTUNKGABEL-SET GROSS
EN	DIPPING FORK SET LARGE
IT	SET FORCHETTINE PRALINERIA GRANDE
ES	JUEGO DE TENEDORES PARA BOMBONES DE CHOCOLATE GRANDE

- |  |  |
|--|--|
| Material: Edelstahl<br>• Griff: Kunststoff (ABS), schwarz<br>• Aufbewahrungs-Ständer aus Edelstahl,<br>aufklappbar, mit Anti-Rutsch-Füßen<br>(L x B x H: 275 x 200 x 225 mm)<br>• Inklusive Kunststoffkoffer<br>(L x B x H: 305 x 260 x 50 mm) | Made of stainless steel<br>• Handle: plastic, black (ABS)<br>• Including rack made of stainless steel,<br>foldable with non-slip feet<br>(L x W x H: 275 x 200 x 225 mm)<br>• Including plastic storage case<br>(L x W x H: 305 x 260 x 50 mm) |
|--|--|

Set bestehend aus:  
je 1 Stück rund (14, 16, 18, 20 mm),  
Dreieck, Spirale, Tropfen, 2-, 3-, 4-zinkig

Set consisting of 1 fork each:  
round (dia. 14, 16, 18, 20 mm) triangle,  
spiral and drop, 2, 3 and 4 points

#		
199034	10-teilig + Ständer / 10 pieces + rack	

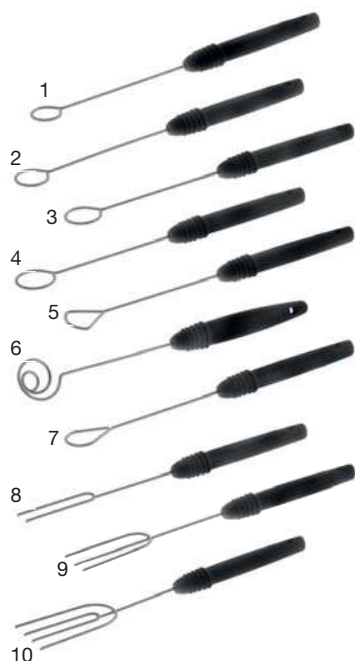

DE	PRALINENTUNKGABELN
EN	DIPPING FORKS
IT	FORCHETTINE PRALINERIA
ES	TENEDORES PARA BOMBONES DE CHOCOLATE

- |   |   |
|---|---|
| Material: Edelstahl<br>• Griff: Kunststoff (ABS), schwarz | Made of stainless steel<br>• Handle: plastic, black (ABS) |
|---|---|

#			↗ mm
199120	rund / round	1	14
199121	rund / round	2	16
199122	rund / round	3	18
199123	rund / round	4	20
199124	Dreieck / triangle	5	
199125	Spirale / spiral	6	
199126	Tropfen / drop	7	
199130	2-zinkig / 2 points	8	
199128	3-zinkig / 3 points	9	
199129	4-zinkig / 4 points	10	



DE	PRALINEN-VORRATSDOSE
EN	STORAGE BOX FOR CHOCOLATES
IT	CONTENITORE PER CIOCCOLATINI
ES	CONTENEDOR PARA BOMBONES

Material: PS, glasklar und stapelbar      Made of PS, crystal clear undstackable

#	↗ mm	→ mm	↑ mm
230030	335	225	73

DE	SPRÜHPISTOLE "ALEXO 500"
EN	SPRAY GUN "ALEXO 500"
IT	PISTOLA POLVERIZZATRICE ELETTRICA DA CIOCCOLATO "ALEXO 500"
ES	PISTOLA PULVERIZADORA ELÉCTRICA PARA CHOCOLATE "ALEXO 500"

- |   |   |
|---|---|
| <ul style="list-style-type: none"> <li>• Speziell für flüssige Schokolade (50 % Schokolade / 50 % Kakaobutter)</li> <li>• <b>100 % lebensmittelecht</b>, 29 – 40 °C</li> <li>• Fördermenge: 120 – 200 ml/min</li> <li>• Viskosität: 20 – 28 DIN/Sek.</li> <li>• Inhalt: 550 ml; Gewicht: 1,06 kg</li> <li>• Leistung: 40 W</li> </ul> | <ul style="list-style-type: none"> <li>• Especially for liquid chocolate (50 % chocolate / 50 % cocoa butter)</li> <li>• <b>100% food safe</b>, useable from 29° to 40° C</li> <li>• Output: 120 – 200 ml/min</li> <li>• Viscosity: 20 – 28 DIN/sec.</li> <li>• Volume: 550 ml; weight: 1.06 kg</li> <li>• Power: 40 W</li> </ul> |
|---|---|

Wird mit Rundstrahldüse R6 geliefert

Delivery includes circular jet nozzle R6



**TIPP!**

50% Schokolade / 50% Kakaobutter  
Temperatur: +29 / +40 °C

#		
153970	Sprühpistole "ALEXO 500" / Spray gun "ALEXO 500"	
153975	Ersatzbehälter mit Deckel / with lid	
153976	Wärmeschutz / insulation sleeve	

DE	KUVERTÜRE- / SCHOKOLADE-ABSTECHER
EN	CHOCOLATE GRATERS
IT	RASCHIA TAGLIA CIOCCOLATA
ES	CORTADORES PARA CHOCOLATE

- |                          |                         |
|--------------------------|-------------------------|
| Material: Edelstahl      | Made of stainless steel |
| • Materialstärke: 0,8 mm | • Thickness: 0.8 mm     |

#	↔ mm	
200610	120 x 115	flach / flat
200611	120 x 110	abgerundet / oblique



DE	SPACHTEL – EXTRA STABIL
EN	SPATULA – EXTRA STRONG
IT	RASCHIA – EXTRA RESISTENTE
ES	ESPATULA PAR CHOCOLATE – MUY FUERTE

- |                                       |   |
|---------------------------------------|---|
| Material: Edelstahl, Griff Kunststoff | Made of stainless steel, plastic handle |
| • Speziell für Schokolade             | • Especially for chocolate              |

#	→ mm
<input checked="" type="checkbox"/> 200700	170
<input checked="" type="checkbox"/> 200701	270
<input checked="" type="checkbox"/> 200710	180



12

DE	KASSEROLLE
EN	SAUCEPAN
IT	CARAFFA GRADUATA PER MICROONDE
ES	CAZO DE POLIPROPILENO PARA FUNDIR CHOCOLATE EN MICROONDAS



- |  |   |
|--|---|
| Material: PP, weiß   | Made of PP, white   |
| • Mit geprägter Skala in Innenseite und zusätzl. blauem Skalendruck auf der Außenseite | • With inside scale and blue printed litre and ml scale outside |
| • Bruchsicher und hygienisch   | • Break resistant   |
| • Auch für Mikrowellengeräte geeignet  | • Suitable for microwave  |
| • Volumen: 2,0 Liter   | • Volume: 2.0 liters  |

#	↗ mm	Ø mm	↑ mm
290200	335	190	120



DE	SCHOKOLADENFORMEN	
EN	CHOCOLATE MOULDS	
IT	STAMPI PER CIOCCOLATO	
ES	MOLDES PARA CHOCOLATE	



Das Gewicht wurde auf der Grundlage von Vollmilch-Schokolade bestimmt und kann je nach Schokoladensorte, der Füllung sowie der Gießtechnik, Abweichungen verzeichnen.  
 Material: Polycarbonat (Kunststoff), sehr robust und stoßfest.

Il peso è determinato in base al cioccolato a latte e può subire variazioni secondo il tipo di cioccolato, il ripieno e la tecnica di fusione.  
 Materiale: policarbonato (plastica), extra robusta e resistente agli urti.

The weight is based on a moulding with solid milk chocolate and may depend on your chocolate, filling and way of moulding.  
 Material: polycarbonate (plastic), very robust and shockproof.

El peso queda determinado a base de chocolate con leche entera y puede ser distinto según el tipo de chocolate, relleno y técnica de moldeo.  
 Material: policarbonato (plástico), muy robusto y resistente a los choques.

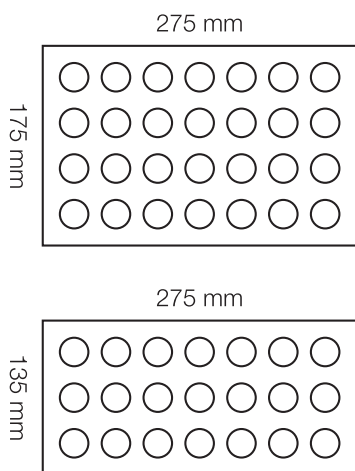

Artikelnummer mit der Bezeichnung „**DF**“ = **Doppelform**. Es wird empfohlen, 2 Formen für die Pralinenherstellung zu verwenden. Jede **DF** hat Zentrierlöcher, damit die Formen zusammen passen. Es müssen pro **DF** mindestens 2 Verbindungsstifte benutzt werden. Von dem Verbindungsstift gibt es nur eine Größe (# 429999). Für jede DF können individuell zwischen 2-4 Klammern verwendet werden, damit die Formen geschlossen zusammenhalten. Bei den Klammern hängt die Größe von der Rahmenhöhe der Schokoladenform ab.

Article number with the description „**DM**“ = **Double mould**. It is recommended, to use 2 moulds for praline making. Each **DM** has centering holes, so that the moulds fit together. At least 2 connecting pins must be used per **DM**. There is only one size of the connecting pin (# 429999). Between 2-4 clamps can be used individually for each DM, to keep the moulds closed together. For the clamps, the size depends on the frame height of the chocolate mould.

DE	ZUBEHÖR FÜR DOPPELFORMEN
EN	ACCESSORIES FOR DOUBLE MOULDS
IT	ACCESSORI PER STAMPI DOPPI
ES	ACCESORIOS PARA MOLDES DOBLES



**KLAMMER, Kunststoff**  
**CLAMP, made of plastic**

#	↑ mm
429998	24

**VERBINDUNGSSTIFT, Edelstahl**  
**CONNECTING PIN, stainless steel**

#	↑ mm
429999	



**KLAMMER, Edelstahl**  
**CLAMP, stainless steel**

#	↑ mm
429990	22
429991	23
429992	26
429993	28

#	↑ mm
429994	30
429995	32
429996	35
429997	40



Anwendungsbeispiele / Application examples



DE	VALENTIN
EN	VALENTINE
IT	SAN VALENTINO
ES	SAN VALENTÍN



#	421012
↔ ↑ mm	275 x 135 x 24
Stückzahl / pcs.	3 x 8
↔ mm	31 x 29 x 19
Stk./g	13



#	421023
↔ ↑ mm	275 x 135 x 24
Stückzahl / pcs.	3 x 8
↔ mm	30 x 22 x 20
Stk./g	11



#	421214
↔ ↑ mm	275 x 135 x 24
Stückzahl / pcs.	3 x 8
↔ mm	31 x 35 x 18
Stk./g	15



# - DF / DM	421280
↔ ↑ mm	275 x 135 x 24
Stückzahl / pcs.	3 x 8
↔ mm	30 x 26 x 9
Stk./g	2 x 5



#	421296
↔ ↑ mm	275 x 135 x 24
Stückzahl / pcs.	3 x 7
↔ mm	49 x 26 x 17
Stk./g	15



#	421297
↔ ↑ mm	275 x 135 x 24
Stückzahl / pcs.	1 x 7
↔ mm	102 x 36 x 19
Stk./g	41



#	421417
↔ ↑ mm	275 x 135 x 24
Stückzahl / pcs.	3 x 8
↔ mm	33 x 31 x 15
Stk./g	11



# - DF / DM	421513
↔ ↑ mm	275 x 135 x 24
Stückzahl / pcs.	3 x 7
↔ mm	35 x 33 x 11
Stk./g	2 x 8,6



#	421517
↔ ↑ mm	275 x 135 x 24
Stückzahl / pcs.	3 x 7
↔ mm	45 x 27 x 17
Stk./g	11



#	421526
↔ ↑ mm	275 x 135 x 24
Stückzahl / pcs.	4 x 7
↔ mm	31 x 27 x 17
Stk./g	9



#	421726
↔ ↑ mm	275 x 135 x 24
Stückzahl / pcs.	3 x 12
↔ mm	32 x 15,5 x 8
Stk./g	2,5



#	421937
↔ ↑ mm	275 x 135 x 24
Stückzahl / pcs.	3 x 7
↔ mm	42 x 21,5 x 15
Stk./g	8,5

DE	VALENTIN
EN	VALENTINE
IT	SAN VALENTINO
ES	SAN VALENTÍN



# - DF / DM	421145
↔ ↑ mm	275 x 135 x 24
Stückzahl / pcs.	2 x 4
↔ mm	65 x 57 x 14
Stk./g	2 x 35



# - DF / DM	421146
↔ ↑ mm	275 x 135 x 24
Stückzahl / pcs.	1 x 5
↔ mm	80 x 69 x 16
Stk./g	2 x 68



#	421147
↔ ↑ mm	275 x 135 x 24
Stückzahl / pcs.	1 x 3
↔ mm	95 x 83 x 19
Stk./g	118



#	421148
↔ ↑ mm	275 x 135 x 26
Stückzahl / pcs.	1 x 2
↔ mm	119 x 104 x 23
Stk./g	2 x 205



#	421216
↔ ↑ mm	275 x 135 x 24
Stückzahl / pcs.	3 x 9
↔ mm	30 x 22 x 20
Stk./g	11



#	421218
↔ ↑ mm	275 x 135 x 24
Stückzahl / pcs.	3 x 7
↔ mm	30 x 36 x 19
Stk./g	14



#	421576
↔ ↑ mm	275 x 135 x 24
Stückzahl / pcs.	3 x 7 / 3 Fig.
↔ mm	29 x 34,5 x 17
Stk./g	12



#	421744
↔ ↑ mm	275 x 135 x 24
Stückzahl / pcs.	3 x 8
↔ mm	33 x 22,5 x 16
Stk./g	10,5



#	422121
↔ ↑ mm	275 x 175 x 24
Stückzahl / pcs.	1 x 2
↔ mm	145 x 126 x 20
Stk./g	305



#	422122
↔ ↑ mm	275 x 175 x 24
Stückzahl / pcs.	1 x 2
↔ mm	145 x 126 x 20
Stk./g	300



#	421892
↔ ↑ mm	275 x 135 x 24
Stückzahl / pcs.	3 x 6
↔ mm	33 x 33 x 10
Stk./g	5



#	421893
↔ ↑ mm	275 x 135 x 24
Stückzahl / pcs.	3 x 7
↔ mm	43 x 23,5 x 13,5
Stk./g	8,5

DE	OSTERN
EN	EASTER
IT	PASQUA
ES	PASCUA



# - DF / DM	421053
↔ ↑ mm	275 x 135 x 24
Stückzahl / pcs.	4 x 8
↔ mm	32 x 22 x 11
Stk./g	2 x 5



# - DF / DM	421266
↔ ↑ mm	275 x 135 x 24
Stückzahl / pcs.	3 x 8
↔ mm	35 x 23 x 12
Stk./g	2 x 6



# - DF / DM	421317
↔ ↑ mm	275 x 135 x 24
Stückzahl / pcs.	3 x 8
↔ mm	43 x 30 x 14
Stk./g	2 x 12



#	421362
↔ ↑ mm	275 x 135 x 24
Stückzahl / pcs.	3 x 8
↔ mm	38 x 25 x 14
Stk./g	12



# - DF / DM	421383
↔ ↑ mm	275 x 135 x 24
Stückzahl / pcs.	3 x 8
↔ mm	42 x 27 x 14
Stk./g	2 x 11



# - DF / DM	421516
↔ ↑ mm	275 x 135 x 24
Stückzahl / pcs.	5 x 7
↔ mm	29 x 21 x 10
Stk./g	2 x 4



# - DF / DM	421537
↔ ↑ mm	275 x 135 x 24
Stückzahl / pcs.	3 x 9
↔ mm	35 x 23 x 12
Stk./g	2 x 6



# - DF / DM	421050
↔ ↑ mm	275 x 135 x 24
Stückzahl / pcs.	5 x 7
↔ mm	29 x 21 x 10
Stk./g	2 x 4



# - DF / DM	421251
↔ ↑ mm	275 x 135 x 28
Stückzahl / pcs.	2 x 4
↔ mm	70 x 47 x 25
Stk./g	2 x 54



# - DF / DM	421252
↔ ↑ mm	275 x 135 x 32
Stückzahl / pcs.	2 x 3
↔ mm	81 x 54 x 30
Stk./g	2 x 83



# - DF / DM	421253
↔ ↑ mm	275 x 135 x 32
Stückzahl / pcs.	2 x 3
↔ mm	86 x 58 x 30
Stk./g	2 x 97



# - DF / DM	421254
↔ ↑ mm	275 x 135 x 35
Stückzahl / pcs.	2 x 2
↔ mm	100 x 65 x 35
Stk./g	2 x 135

DE	OSTERN
EN	EASTER
IT	PASQUA
ES	PASCUA



# - DF / DM	421255
↔ ↑ mm	275 x 135 x 40
Stückzahl / pcs.	1 x 3
↔ mm	118 x 77 x 40
Stk./g	2 x 227



# - DF / DM	421358
↔ ↑ mm	275 x 135 x 24
Stückzahl / pcs.	3 x 9
↔ mm	29 x 23 x 11
Stk./g	2 x 4,5



# - DF / DM	421582
↔ ↑ mm	275 x 135 x 24
Stückzahl / pcs.	3 x 8
↔ mm	33 x 23 x 12
Stk./g	2 x 5



# - DF / DM	421640
↔ ↑ mm	275 x 135 x 24
Stückzahl / pcs.	3 x 6
↔ mm	34 x 35 x 14
Stk./g	2 x 12



#	421641
↔ ↑ mm	275 x 135 x 24
Stückzahl / pcs.	3 x 7 / 7 Fig.
↔ mm	31 x 31 x 9
Stk./g	9



# - DF / DM	421656
↔ ↑ mm	275 x 135 x 24
Stückzahl / pcs.	3 x 6
↔ mm	38 x 27,5 x 15
Stk./g	2 x 7



# - DF / DM	421664
↔ ↑ mm	275 x 135 x 30
Stückzahl / pcs.	3 x 4 / 3 Fig.
↔ mm	62 x 41,5 x 23
Stk./g	2 x 35



# - DF / DM	421739
↔ ↑ mm	275 x 135 x 24
Stückzahl / pcs.	1 x 4
↔ mm	99,5 x 45,5 x 19
Stk./g	2 x 49



# - DF / DM	421786
↔ ↑ mm	275 x 135 x 24
Stückzahl / pcs.	3 x 8
↔ mm	33 x 26,5 x 13
Stk./g	2 x 13



# - DF / DM	421873
↔ ↑ mm	275 x 135 x 40
Stückzahl / pcs.	2 x 3
↔ mm	72 x 55 x 35
Stk./g	2 x 46,6



# - DF / DM	421888
↔ ↑ mm	275 x 135 x 35
Stückzahl / pcs.	2 x 3
↔ mm	86,5 x 56,5 x 25,5
Stk./g	2 x 69,7



# - DF / DM	421889
↔ ↑ mm	275 x 135 x 40
Stückzahl / pcs.	2 x 3
↔ mm	86,5 x 56,5 x 33,5
Stk./g	2 x 89,5

DE	OSTERN
EN	EASTER
IT	PASQUA
ES	PASCUA



# - DF / DM	421891
↖↗ mm	275 x 135 x 24
Stückzahl / pcs.	3 x 8
↔ mm	33 x 23 x 11
Stk./g	2 x 5,5



# - DF / DM	421554
↖↗ mm	275 x 135 x 24
Stückzahl / pcs.	4 x 8
↔ mm	32 x 22 x 24
Stk./g	2 x 5



# - DF / DM	421907
↖↗ mm	275 x 135 x 24
Stückzahl / pcs.	5 x 7
↔ mm	29 x 21 x 10
Stk./g	2 x 4



# - DF / DM	421910
↖↗ mm	275 x 135 x 35
Stückzahl / pcs.	2 x 3
↔ mm	86,5 x 56 x 30
Stk./g	2 x 94,5



# - DF / DM	422395
↖↗ mm	275 x 175 x 24
Stückzahl / pcs.	4 x 8 / 3 Fig.
↔ mm	33 x 23 x 12
Stk./g	2 x 5



12

DE	WEIHNACHTEN UND NEUJAHR
EN	CHRISTMAS AND NEW YEAR
IT	NATALE E CAPODANNO
ES	NAVIDAD Y AÑO NUEVO



#	421209
↖↗ mm	275 x 135 x 24
Stückzahl / pcs.	2 x 7
↔ mm	57 x 32 x 7
Stk./g	5



# - DF / DM	421635
↖↗ mm	275 x 135 x 24
Stückzahl / pcs.	2 x 4
↔ mm	48 x 40 x 18
Stk./g	2 x 16



# - DF / DM	422037
↖↗ mm	275 x 175 x 24
Stückzahl / pcs.	2 x 9
↔ mm	66 x 23 x 12
Stk./g	2 x 11

DE	WEIHNACHTEN UND NEUJAHR
EN	CHRISTMAS AND NEW YEAR
IT	NATALE E CAPODANNO
ES	NAVIDAD Y AÑO NUEVO



# - DF / DM	422038
↔ ↑ mm	275 x 175 x 24
Stückzahl / pcs.	6 x 2
↔ mm	90 x 24 x 12
Stk./g	2 x 15



#	421078
↔ ↑ mm	275 x 135 x 24
Stückzahl / pcs.	4 x 3 / 2 Fig.
↔ mm	67 x 29 x 8
Stk./g	9,5



#	421079
↔ ↑ mm	275 x 135 x 24
Stückzahl / pcs.	1 x 6
↔ mm	110 x 36 x 10
Stk./g	34



#	421302
↔ ↑ mm	275 x 135 x 24
Stückzahl / pcs.	3 x 7
↔ mm	40 x 30 x 15
Stk./g	12



#	421333
↔ ↑ mm	275 x 135 x 24
Stückzahl / pcs.	3 x 7
↔ mm	38 x 30 x 20
Stk./g	15



#	421406
↔ ↑ mm	275 x 135 x 24
Stückzahl / pcs.	3 x 6 / 6 Fig.
↔ mm	43 x 32 x 7
Stk./g	6



#	421439
↔ ↑ mm	275 x 135 x 24
Stückzahl / pcs.	3 x 4
↔ mm	57 x 32 x 10
Stk./g	7



#	421655
↔ ↑ mm	275 x 135 x 24
Stückzahl / pcs.	1 x 6
↔ mm	100 x 35 x 13
Stk./g	30



# - DF / DM	421868
↔ ↑ mm	275 x 135 x 30
Stückzahl / pcs.	1 x 4
↔ mm	100 x 59 x 21
Stk./g	55,5 + 49



#	421869
↔ ↑ mm	275 x 135 x 24
Stückzahl / pcs.	3 x 8
↔ mm	34,5 x 25 x 18
Stk./g	10,5



#	421870
↔ ↑ mm	275 x 135 x 24
Stückzahl / pcs.	3 x 7
↔ mm	40 x 25 x 18
Stk./g	10,5



# - DF / DM	421878
↔ ↑ mm	275 x 135 x 30
Stückzahl / pcs.	1 x 4
↔ mm	80 x 59
Stk./g	57 + 50,5

DE	NATUR
EN	NATURE
IT	NATURA
ES	NATURALEZA



#	421033
↙↑ mm	275 x 135 x 24
Stückzahl / pcs.	3 x 7
↔ mm	34 x 34 x 20
Stk./g	18



#	421048
↙↑ mm	275 x 135 x 24
Stückzahl / pcs.	2 x 5 / 5 Fig.
↔ mm	43 x 43 x 5
Stk./g	6



#	421058
↙↑ mm	275 x 135 x 24
Stückzahl / pcs.	3 x 7
↔ mm	28 x 28 x 20
Stk./g	12



#	421134
↙↑ mm	275 x 135 x 24
Stückzahl / pcs.	3 x 8
↔ mm	33 x 24 x 20
Stk./g	13



#	421519
↙↑ mm	275 x 135 x 24
Stückzahl / pcs.	3 x 7
↔ mm	33 x 27 x 17
Stk./g	11,5



#	421637
↙↑ mm	275 x 135 x 24
Stückzahl / pcs.	3 x 8
↔ mm	26 x 26 x 16
Stk./g	10



# - DF / DM	421826
↙↑ mm	275 x 135 x 24
Stückzahl / pcs.	3 x 6
↔ mm	37,5 x 34,5 x 6
Stk./g	2 x 5



#	421830
↙↑ mm	275 x 135 x 24
Stückzahl / pcs.	3 x 7
↔ mm	44,5 x 26 x 13,5
Stk./g	10



# - DF / DM	421197
↙↑ mm	275 x 135 x 24
Stückzahl / pcs.	3 x 7
↔ mm	30 x 30 x 15
Stk./g	2 x 8



#	421568
↙↑ mm	275 x 135 x 24
Stückzahl / pcs.	4 x 8
↔ mm	25 x 24,5 x 18
Stk./g	8



#	421669
↙↑ mm	275 x 135 x 24
Stückzahl / pcs.	2 x 5
↔ mm	41 x 41 x 7
Stk./g	13



# - DF / DM	421917
↙↑ mm	275 x 135 x 24
Stückzahl / pcs.	3 x 7
↔ mm	30 x 30 x 10
Stk./g	2 x 5

DE	ÜBERZIEHPRALINEN
EN	ENROBED CHOCOLATES
IT	CIOCCOLATINI RICOPERTI
ES	BOMBONES BAÑADOS



#	421037
↔ ↑ mm	275 x 135 x 24
Stückzahl / pcs.	3 x 7
↔ mm	35 x 35 x 21
Stk./g	16



#	421219
↔ ↑ mm	275 x 135 x 24
Stückzahl / pcs.	3 x 8
↔ mm	27 x 22 x 15
Stk./g	11



#	421289
↔ ↑ mm	275 x 135 x 24
Stückzahl / pcs.	3 x 8
↔ mm	25 x 25 x 20
Stk./g	11



#	421290
↔ ↑ mm	275 x 135 x 24
Stückzahl / pcs.	3 x 8
↔ mm	29 x 29 x 17
Stk./g	11



#	421300
↔ ↑ mm	275 x 135 x 24
Stückzahl / pcs.	3 x 8
↔ mm	33 x 22 x 18
Stk./g	11



#	421384
↔ ↑ mm	275 x 135 x 24
Stückzahl / pcs.	3 x 8
↔ mm	36 x 25 x 19
Stk./g	16



#	421393
↔ ↑ mm	275 x 135 x 24
Stückzahl / pcs.	3 x 8
↔ mm	36 x 26 x 18
Stk./g	18



#	421561
↔ ↑ mm	275 x 135 x 24
Stückzahl / pcs.	3 x 7
↔ mm	27,5 x 27,5 x 14,9
Stk./g	7,15



#	422432
↔ ↑ mm	275 x 175 x 24
Stückzahl / pcs.	4 x 8
↔ mm	34,5 x 25,7 x 17
Stk./g	14

© stock.adobe.com



DE	HERBST UND NÜSSE
EN	AUTUMN AND NUTS
IT	AUTUNNO E NOCI
ES	OTOÑO Y NUECES



#	421015
↔ ↑ mm	275 x 135 x 24
Stückzahl / pcs.	3 x 8
↔ mm	38 x 29 x 18
Stk./g	13



#	421027
↔ ↑ mm	275 x 135 x 24
Stückzahl / pcs.	3 x 8
↔ mm	37 x 27 x 18
Stk./g	12



#	421046
↔ ↑ mm	275 x 135 x 24
Stückzahl / pcs.	3 x 7
↔ mm	37 x 31 x 16
Stk./g	14



#	421089
↔ ↑ mm	275 x 135 x 24
Stückzahl / pcs.	3 x 8
↔ mm	37 x 31 x 20
Stk./g	16



# - DF / DM	421093
↔ ↑ mm	275 x 135 x 24
Stückzahl / pcs.	3 x 8
↔ mm	37 x 29 x 14
Stk./g	2 x 7,5



#	421095
↔ ↑ mm	275 x 135 x 24
Stückzahl / pcs.	3 x 5
↔ mm	49 x 36 x 13
Stk./g	17



#	421104
↔ ↑ mm	275 x 135 x 24
Stückzahl / pcs.	3 x 7
↔ mm	40 x 35 x 10
Stk./g	10



#	421191
↔ ↑ mm	275 x 135 x 24
Stückzahl / pcs.	2 x 11
↔ mm	47 x 19 x 17
Stk./g	13



#	421226
↔ ↑ mm	275 x 135 x 24
Stückzahl / pcs.	3 x 8
↔ mm	29 x 28 x 17
Stk./g	12



#	421483
↔ ↑ mm	275 x 135 x 24
Stückzahl / pcs.	4 x 5
↔ mm	49 x 28 x 15
Stk./g	21



# - DF / DM	421498
↔ ↑ mm	275 x 135 x 24
Stückzahl / pcs.	4 x 4
↔ mm	58 x 21 x 9
Stk./g	2 x 6



#	422343
↔ ↑ mm	275 x 175 x 24
Stückzahl / pcs.	6 x 3
↔ mm	77 x 18 x 19
Stk./g	27

DE	KAFFEEBOHNEN
EN	COFFEE BEANS
IT	CHICCHI DI CAFFÈ
ES	GRANOS DE CAFÉ



#	421019
↙↗ mm	275 x 135 x 28
Stückzahl / pcs.	4 x 9
↔ mm	25 x 25 x 25
Stk./g	14



#	421327
↙↗ mm	275 x 135 x 24
Stückzahl / pcs.	3 x 8
↔ mm	36 x 24 x 16
Stk./g	11



#	421529
↙↗ mm	275 x 135 x 24
Stückzahl / pcs.	4 x 7
↔ mm	33 x 22 x 14,5
Stk./g	8,6



# - DF / DM	422370
↙↗ mm	275 x 175 x 26
Stückzahl / pcs.	3 x 4
↔ mm	74 x 38 x 20
Stk./g	2 x 30



# - DF / DM	421558
↙↗ mm	275 x 135 x 24
Stückzahl / pcs.	2 x 8
↔ mm	50 x 24 x 12
Stk./g	2 x 8



#	421540
↙↗ mm	275 x 135 x 24
Stückzahl / pcs.	3 x 7
↔ mm	34 x 34 x 5
Stk./g	4,35



#	422431
↙↗ mm	275 x 175 x 24
Stückzahl / pcs.	4 x 7
↔ mm	34,5 x 34,5 x 4,5
Stk./g	4,5



#	421877
↙↗ mm	275 x 135 x 24
Stückzahl / pcs.	3 x 7
↔ mm	27 x 27 x 16
Stk./g	12



#	421880
↙↗ mm	275 x 135 x 24
Stückzahl / pcs.	3 x 8
↔ mm	20 x 20 x 19
Stk./g	6,9



#	421901
↙↗ mm	275 x 135 x 24
Stückzahl / pcs.	3 x 7
↔ mm	31,5 x 31,5 x 5
Stk./g	5



# - DF / DM	421919
↙↗ mm	275 x 135 x 24
Stückzahl / pcs.	7 x 9
↔ mm	19 x 9 x 4
Stk./g	2 x 0,6

DE	FIGUREN
EN	FIGURES
IT	FIGURE
ES	FIGURAS



#	421006
↔ ↑ mm	275 x 135 x 24
Stückzahl / pcs.	3 x 8
↔ mm	38 x 27 x 16
Stk./g	15



#	421411
↔ ↑ mm	275 x 135 x 24
Stückzahl / pcs.	3 x 5
↔ mm	50 x 35 x 12
Stk./g	12



#	421457
↔ ↑ mm	275 x 135 x 24
Stückzahl / pcs.	3 x 4
↔ mm	61 x 31 x 19
Stk./g	23



# - DF / DM	421666
↔ ↑ mm	275 x 135 x 24
Stückzahl / pcs.	3 x 8
↔ mm	26 x 19 x 27
Stk./g	7 + 9



# - DF / DM	421727
↔ ↑ mm	275 x 135 x 24
Stückzahl / pcs.	3 x 6
↔ mm	37,5 x 32 x 12,5
Stk./g	2 x 7,5



# - DF / DM	421874
↔ ↑ mm	275 x 135 x 24
Stückzahl / pcs.	3 x 6
↔ mm	36,5 x 34
Stk./g	9 + 7,5



#	421129
↔ ↑ mm	275 x 135 x 24
Stückzahl / pcs.	2 x 5
↔ mm	66 x 45 x 14
Stk./g	20



#	421746
↔ ↑ mm	275 x 135 x 24
Stückzahl / pcs.	3 x 5 / 5 Fig.
↔ mm	unterschiedlich
Stk./g	12



# - DF / DM	421931
↔ ↑ mm	275 x 135 x 24
Stückzahl / pcs.	1 x 4
↔ mm	80 x 69 x 16,5
Stk./g	2 x 34



# - DF / DM	421933
↔ ↑ mm	275 x 135 x 24
Stückzahl / pcs.	2 x 6
↔ mm	45 x 39,5 x 9,5
Stk./g	2 x 6



#	421934
↔ ↑ mm	275 x 135 x 24
Stückzahl / pcs.	1 x 4 / 4 Fig.
↔ mm	unterschiedlich
Stk./g	20



# - DF / DM	421938
↔ ↑ mm	275 x 135 x 24
Stückzahl / pcs.	2 x 7
↔ mm	37,5 x 30 x 12
Stk./g	2 x 7,5

DE	HOBBYS
EN	HOBBIES
IT	HOBBY
ES	HOBBIES



# - DF / DM	421423
↙↑ mm	275 x 135 x 35
Stückzahl / pcs.	2 x 4
↔ mm	60 x 60 x 30
Stk./g	2 x 35



# - DF / DM	421428
↙↑ mm	275 x 135 x 24
Stückzahl / pcs.	4 x 8
↔ mm	26 x 26 x 13
Stk./g	2 x 6



# - DF / DM	421443
↙↑ mm	275 x 135 x 24
Stückzahl / pcs.	3 x 8
↔ mm	30 x 30 x 15
Stk./g	2 x 8,5



#	421493
↙↑ mm	275 x 135 x 24
Stückzahl / pcs.	4 x 8
↔ mm	28 x 28 x 16
Stk./g	10



# - DF / DM	421674
↙↑ mm	275 x 135 x 24
Stückzahl / pcs.	2 x 4
↔ mm	61 x 45 x 10
Stk./g	2 x 10



# - DF / DM	421224
↙↑ mm	275 x 135 x 24
Stückzahl / pcs.	3 x 9
↔ mm	30 x 24 x 11
Stk./g	2 x 7

DE	BUCHSTABEN
EN	LETTERS
IT	LETTERE
ES	LETRAS

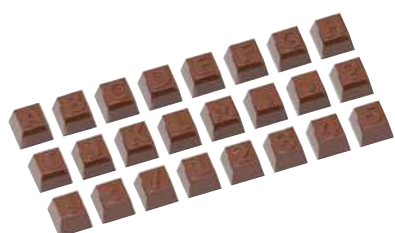

#	421628
↙↑ mm	275 x 135 x 24
Stückzahl / pcs.	3 x 8 / 24 Fig.
↔ mm	26 x 26 x 18,5
Stk./g	12

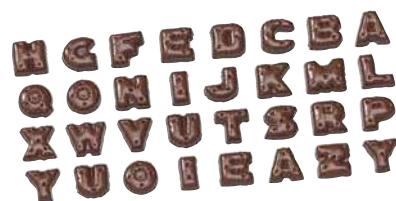

#	421643
↙↑ mm	275 x 135 x 24
Stückzahl / pcs.	4 x 8 / 26 Fig.
↔ mm	29 x 25 x 9
Stk./g	-

DE	KEKSE
EN	BISCUITS
IT	BISCOTTINI
ES	GALLETAS



#	421357
↔ ↑ mm	275 x 135 x 24
Stückzahl / pcs.	3 x 8
↔ mm	30 x 30 x 7
Stk./g	5



#	421456
↔ ↑ mm	275 x 135 x 24
Stückzahl / pcs.	3 x 6
↔ mm	39 x 39 x 5
Stk./g	9



#	422018
↔ ↑ mm	275 x 175 x 24
Stückzahl / pcs.	2 x 6
↔ mm	78 x 38 x 4
Stk./g	9



#	422054
↔ ↑ mm	275 x 175 x 24
Stückzahl / pcs.	4 x 6
↔ mm	36 x 36 x 4
Stk./g	5



#	422360
↔ ↑ mm	275 x 175 x 24
Stückzahl / pcs.	3 x 6
↔ mm	33 x 33 x 5
Stk./g	6

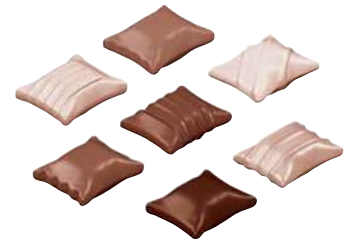

# - DF / DM	421597
↔ ↑ mm	275 x 135 x 24
Stückzahl / pcs.	2 x 6 / 6 Fig.
↔ mm	36 x 28 x 9
Stk./g	2 x 6



#	421321
↔ ↑ mm	275 x 135 x 24
Stückzahl / pcs.	3 x 8
↔ mm	27 x 27 x 6
Stk./g	3



#	421795
↔ ↑ mm	275 x 135 x 24
Stückzahl / pcs.	3 x 8
↔ mm	25 x 25 x 7
Stk./g	3,5



#	421847
↔ ↑ mm	275 x 135 x 24
Stückzahl / pcs.	3 x 7
↔ mm	35 x 35 x 9
Stk./g	6



#	421865
↔ ↑ mm	275 x 135 x 24
Stückzahl / pcs.	3 x 8
↔ mm	25,5 x 25,5 x 15
Stk./g	9



#	421853
↔ ↑ mm	275 x 135 x 24
Stückzahl / pcs.	3 x 7
↔ mm	28,5 x 28,5 x 5
Stk./g	4,4



#	421887
↔ ↑ mm	275 x 135 x 24
Stückzahl / pcs.	3 x 7
↔ mm	30,5 x 30,5 x 5,6
Stk./g	5,7

DE	FANTASIE
EN	FANTASY
IT	FANTASIA
ES	FANTASÍA



#	421024
↔↑ mm	275 x 135 x 24
Stückzahl / pcs.	3 x 7
↔ mm	31 x 31 x 20
Stk./g	15



#	421025
↔↑ mm	275 x 135 x 24
Stückzahl / pcs.	3 x 8
↔ mm	36 x 22 x 20
Stk./g	15



#	421031
↔↑ mm	275 x 135 x 26
Stückzahl / pcs.	3 x 8
↔ mm	37 x 23 x 20
Stk./g	17



#	421036
↔↑ mm	275 x 135 x 24
Stückzahl / pcs.	3 x 8
↔ mm	29 x 29 x 20
Stk./g	17



#	421045
↔↑ mm	275 x 135 x 24
Stückzahl / pcs.	3 x 8
↔ mm	30 x 27 x 19
Stk./g	13



#	421081
↔↑ mm	275 x 135 x 32
Stückzahl / pcs.	3 x 7
↔ mm	32 x 32 x 28
Stk./g	22



#	421082
↔↑ mm	275 x 135 x 24
Stückzahl / pcs.	3 x 10
↔ mm	35 x 20 x 17
Stk./g	14



#	421094
↔↑ mm	275 x 135 x 28
Stückzahl / pcs.	3 x 8
↔ mm	31 x 31 x 22
Stk./g	15



#	421189
↔↑ mm	275 x 135 x 24
Stückzahl / pcs.	3 x 8
↔ mm	30 x 27 x 16
Stk./g	12



#	421225
↔↑ mm	275 x 135 x 24
Stückzahl / pcs.	3 x 8
↔ mm	33 x 25 x 21
Stk./g	14



#	421263
↔↑ mm	275 x 135 x 24
Stückzahl / pcs.	3 x 7
↔ mm	37 x 27 x 15
Stk./g	15



#	421301
↔↑ mm	275 x 135 x 24
Stückzahl / pcs.	3 x 8
↔ mm	30 x 30 x 16
Stk./g	10

DE	FANTASIE
EN	FANTASY
IT	FANTASIA
ES	FANTASÍA



#	421397
↔ ↑ mm	275 x 135 x 24
Stückzahl / pcs.	3 x 8
↔ mm	29 x 25 x 19
Stk./g	13



#	421533
↔ ↑ mm	275 x 135 x 24
Stückzahl / pcs.	1 x 10
↔ mm	11,5 x 24 x 13
Stk./g	9



#	421638
↔ ↑ mm	275 x 135 x 24
Stückzahl / pcs.	2 x 7
↔ mm	48 x 29 x 15
Stk./g	9,8



#	421647
↔ ↑ mm	275 x 135 x 24
Stückzahl / pcs.	3 x 8
↔ mm	26 x 26 x 12
Stk./g	9



# - DF / DM	421673
↔ ↑ mm	275 x 135 x 24
Stückzahl / pcs.	2 x 8
↔ mm	45,5 x 25 x 12,5
Stk./g	2 x 10



#	421676
↔ ↑ mm	275 x 135 x 26
Stückzahl / pcs.	4 x 8
↔ mm	22,5 x 22,5 x 19,5
Stk./g	11,5



#	422009
↔ ↑ mm	275 x 175 x 24
Stückzahl / pcs.	5 x 6
↔ mm	38 x 21 x 13
Stk./g	7



#	422169
↔ ↑ mm	275 x 175 x 26
Stückzahl / pcs.	5 x 8
↔ mm	28 x 28 x 24
Stk./g	13



#	421760
↔ ↑ mm	275 x 135 x 30
Stückzahl / pcs.	3 x 7
↔ mm	27 x 27 x 22
Stk./g	8



#	421779
↔ ↑ mm	275 x 135 x 24
Stückzahl / pcs.	3 x 5
↔ mm	38,5 x 22,5 x 17,5
Stk./g	12,5



#	421781
↔ ↑ mm	275 x 135 x 24
Stückzahl / pcs.	2 x 7
↔ mm	42,5 x 31 x 18,5
Stk./g	10,5

DE	FANTASIE
EN	FANTASY
IT	FANTASIA
ES	FANTASÍA



#	421784
↙↑ mm	275 x 135 x 24
Stückzahl / pcs.	3 x 8
↔ mm	48 x 16,5 x 13,5
Stk./g	8



#	421794
↙↑ mm	275 x 135 x 30
Stückzahl / pcs.	3 x 8
↔ mm	26 x 26 x 25,5
Stk./g	12,5

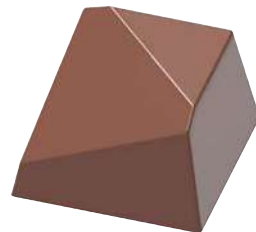

#	421799
↙↑ mm	275 x 135 x 24
Stückzahl / pcs.	3 x 7
↔ mm	27,6 x 27,6 x 17,2
Stk./g	12,5

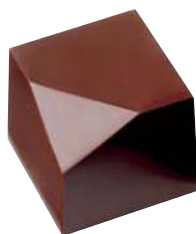

#	421840
↙↑ mm	275 x 135 x 30
Stückzahl / pcs.	3 x 8
↔ mm	23 x 23 x 20
Stk./g	12



#	421842
↙↑ mm	275 x 135 x 30
Stückzahl / pcs.	3 x 7
↔ mm	27,5 x 27,5 x 24
Stk./g	10,5

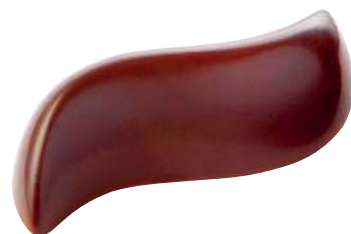

#	421848
↙↑ mm	275 x 135 x 24
Stückzahl / pcs.	3 x 7
↔ mm	50 x 25 x 15
Stk./g	7,5



#	421859
↙↑ mm	275 x 135 x 26
Stückzahl / pcs.	3 x 7
↔ mm	24,5 x 23,5 x 21,5
Stk./g	9



#	421866
↙↑ mm	275 x 135 x 24
Stückzahl / pcs.	3 x 8
↔ mm	30,5 x 19 x 17
Stk./g	9,5



#	421858
↙↑ mm	275 x 135 x 24
Stückzahl / pcs.	3 x 7
↔ mm	32,5 x 28,5 x 15,5
Stk./g	9,5



#	421883
↙↑ mm	275 x 135 x 24
Stückzahl / pcs.	1 x 7
↔ mm	100 x 30 x 20
Stk./g	28



#	421885
↙↑ mm	275 x 135 x 24
Stückzahl / pcs.	3 x 8
↔ mm	26 x 26 x 16
Stk./g	12



# - DF / DM	421622
↙↑ mm	275 x 135 x 24
Stückzahl / pcs.	2 x 5
↔ mm	117 x 15 x 6,5
Stk./g	2 x 9,5



DE	FANTASIE
EN	FANTASY
IT	FANTASIA
ES	FANTASÍA



#	421903
↔ ↑ mm	275 x 135 x 24
Stückzahl / pcs.	3 x 7
↔ mm	45,5 x 28,5 x 14
Stk./g	7,5



#	421904
↔ ↑ mm	275 x 135 x 24
Stückzahl / pcs.	3 x 7
↔ mm	42 x 31 x 16
Stk./g	8



#	421028
↔ ↑ mm	275 x 135 x 24
Stückzahl / pcs.	3 x 8
↔ mm	33 x 27 x 19
Stk./g	15



#	421092
↔ ↑ mm	275 x 135 x 24
Stückzahl / pcs.	3 x 8
↔ mm	39 x 28 x 17
Stk./g	15



#	421156
↔ ↑ mm	275 x 135 x 24
Stückzahl / pcs.	5 x 6
↔ mm	37 x 18 x 14
Stk./g	11



#	421173
↔ ↑ mm	275 x 135 x 24
Stückzahl / pcs.	3 x 8
↔ mm	48 x 18 x 20
Stk./g	13



#	421330
↔ ↑ mm	275 x 135 x 24
Stückzahl / pcs.	3 x 8
↔ mm	41 x 21 x 15
Stk./g	14



#	421419
↔ ↑ mm	275 x 135 x 24
Stückzahl / pcs.	3 x 8
↔ mm	31 x 24 x 13
Stk./g	10



#	421479
↔ ↑ mm	275 x 135 x 24
Stückzahl / pcs.	4 x 5
↔ mm	48 x 29 x 11
Stk./g	19



#	421521
↔ ↑ mm	275 x 135 x 24
Stückzahl / pcs.	3 x 8
↔ mm	28,5 x 28,5 x 18
Stk./g	10



#	421544
↔ ↑ mm	275 x 135 x 24
Stückzahl / pcs.	4 x 7
↔ mm	27 x 27 x 16
Stk./g	8,65



#	421545
↔ ↑ mm	275 x 135 x 24
Stückzahl / pcs.	4 x 7
↔ mm	27 x 24 x 17
Stk./g	8,75

DE	FANTASIE
EN	FANTASY
IT	FANTASIA
ES	FANTASÍA



#	421555
↔ ↑ mm	275 x 135 x 24
Stückzahl / pcs.	3 x 7
↔ mm	29,5 x 29,5 x 20,2
Stk./g	12,3



#	421559
↔ ↑ mm	275 x 135 x 24
Stückzahl / pcs.	3 x 8
↔ mm	24,4 x 24,4 x 14,5
Stk./g	7,8



#	421564
↔ ↑ mm	275 x 135 x 24
Stückzahl / pcs.	3 x 7
↔ mm	31 x 31 x 15,4
Stk./g	12,35



#	421575
↔ ↑ mm	275 x 135 x 24
Stückzahl / pcs.	3 x 7
↔ mm	29 x 29 x 20
Stk./g	5,5



#	421617
↔ ↑ mm	275 x 135 x 24
Stückzahl / pcs.	5 x 5
↔ mm	39 x 18 x 15,5
Stk./g	10



#	421630
↔ ↑ mm	275 x 135 x 24
Stückzahl / pcs.	3 x 8
↔ mm	26 x 26 x 18,5
Stk./g	12



#	421646
↔ ↑ mm	275 x 135 x 24
Stückzahl / pcs.	3 x 8
↔ mm	34,5 x 24,5 x 13
Stk./g	10



#	421753
↔ ↑ mm	275 x 135 x 24
Stückzahl / pcs.	3 x 7
↔ mm	27 x 27 x 19
Stk./g	11



#	421754
↔ ↑ mm	275 x 135 x 28
Stückzahl / pcs.	3 x 6
↔ mm	38 x 32 x 22,5
Stk./g	10



#	422392
↔ ↑ mm	275 x 175 x 24
Stückzahl / pcs.	4 x 8
↔ mm	27,5 x 27,5 x 15
Stk./g	7,5



#	421764
↔ ↑ mm	275 x 135 x 32
Stückzahl / pcs.	3 x 7
↔ mm	31 x 31 x 27
Stk./g	9



#	421780
↔ ↑ mm	275 x 135 x 24
Stückzahl / pcs.	3 x 7
↔ mm	46 x 28 x 21
Stk./g	8,47

DE	FANTASIE
EN	FANTASY
IT	FANTASIA
ES	FANTASÍA



#	421782
↙↑ mm	275 x 135 x 30
Stückzahl / pcs.	3 x 6
↔ mm	44,5 x 32 x 22,5
Stk./g	11



#	422371
↙↑ mm	275 x 175 x 24
Stückzahl / pcs.	4 x 9 / 6 Fig.
↔ mm	unterschiedlich
Stk./g	6 / 7



#	421905
↙↑ mm	275 x 135 x 24
Stückzahl / pcs.	3 x 7
↔ mm	39,5 x 34,5 x 13,5
Stk./g	8,5



#	421906
↙↑ mm	275 x 135 x 24
Stückzahl / pcs.	1 x 2
↔ mm	103,5 x 89,5 x 13,5
Stk./g	56



#	421908
↙↑ mm	275 x 135 x 24
Stückzahl / pcs.	1 x 7
↔ mm	113 x 28 x 11
Stk./g	31,5



#	421911
↙↑ mm	275 x 135 x 24
Stückzahl / pcs.	2 x 6 / 3 Fig.
↔ mm	unterschiedlich
Stk./g	5,5



# - DF / DM	421912
↙↑ mm	275 x 135 x 24
Stückzahl / pcs.	3 x 6
↔ mm	39 x 34 x 7
Stk./g	2 x 5,5



#	421915
↙↑ mm	275 x 135 x 24
Stückzahl / pcs.	3 x 7
↔ mm	27,5 x 27,5 x 17
Stk./g	8



# - DF / DM	421916
↙↑ mm	275 x 135 x 24
Stückzahl / pcs.	1 x 14
↔ mm	120 x 9,5 x 5
Stk./g	2 x 4,8



#	421920
↙↑ mm	275 x 135 x 24
Stückzahl / pcs.	1 x 6
↔ mm	120 x 34 x 10,5
Stk./g	24



#	421921
↙↑ mm	275 x 135 x 24
Stückzahl / pcs.	3 x 7
↔ mm	36,5 x 27,5 x 16,5
Stk./g	10,5



#	421922
↙↑ mm	275 x 135 x 24
Stückzahl / pcs.	3 x 7
↔ mm	35,5 x 35,5 x 17
Stk./g	12

DE	FANTASIE
EN	FANTASY
IT	FANTASIA
ES	FANTASÍA



#	421923
↙↑ mm	275 x 135 x 30
Stückzahl / pcs.	3 x 8
↔ mm	26,5 x 26,5 x 22
Stk./g	9,5



#	421924
↙↑ mm	275 x 135 x 32
Stückzahl / pcs.	3 x 7
↔ mm	31 x 31 x 26,5
Stk./g	9,5



#	421929
↙↑ mm	275 x 135 x 24
Stückzahl / pcs.	1 x 10
↔ mm	99,5 x 19,5 x 11,5
Stk./g	17,5



#	421930
↙↑ mm	275 x 135 x 24
Stückzahl / pcs.	3 x 8
↔ mm	36 x 20 x 15
Stk./g	9,5



#	421932
↙↑ mm	275 x 135 x 28
Stückzahl / pcs.	3 x 7
↔ mm	28 x 28 x 24
Stk./g	13,5



#	421935
↙↑ mm	275 x 135 x 24
Stückzahl / pcs.	3 x 7
↔ mm	35 x 31 x 16,5
Stk./g	11



#	421936
↙↑ mm	275 x 135 x 24
Stückzahl / pcs.	1 x 4
↔ mm	117,5 x 49,5 x 9
Stk./g	57



# - DF / DM	421939
↙↑ mm	275 x 135 x 24
Stückzahl / pcs.	3 x 7
↔ mm	35 x 35 x 8,5
Stk./g	2 x 7



#	422391
↙↑ mm	275 x 175 x 24
Stückzahl / pcs.	3 x 8
↔ mm	47 x 19 x 17
Stk./g	13



DE	TASSEN
EN	CUPS
IT	TAZZE
ES	TAZAS



#	421002
↔ ↑ mm	275 x 135 x 24
Stückzahl / pcs.	3 x 7
↔ mm	30 x 30 x 19
Stk./g	14



#	421003
↔ ↑ mm	275 x 135 x 24
Stückzahl / pcs.	3 x 8
↔ mm	35 x 26 x 19
Stk./g	14



#	421342
↔ ↑ mm	275 x 135 x 32
Stückzahl / pcs.	4 x 8
↔ mm	28 x 28 x 27
Stk./g	17



#	421387
↔ ↑ mm	275 x 135 x 24
Stückzahl / pcs.	3 x 8
↔ mm	30 x 30 x 20
Stk./g	11



#	421585
↔ ↑ mm	275 x 135 x 24
Stückzahl / pcs.	3 x 8
↔ mm	26 x 33 x 14,5
Stk./g	7



12

DE	KUGELN
EN	SPHERES
IT	SFERE
ES	ESFERAS



# - DF / DM	421158
↔ ↑ mm	275 x 135 x 24
Stückzahl / pcs.	4 x 9
↔ mm	25 x 25 x 12,5
Stk./g	2 x 4



# - DF / DM	421217
↔ ↑ mm	275 x 135 x 24
Stückzahl / pcs.	3 x 8
↔ mm	30 x 30 x 15
Stk./g	2 x 9



# - DF / DM	421258
↔ ↑ mm	275 x 135 x 24
Stückzahl / pcs.	4 x 8
↔ mm	27 x 27 x 13,5
Stk./g	2 x 6

DE	KUGELN
EN	SPHERES
IT	SFERE
ES	ESFERAS



# - DF / DM	421495
↔ ↑ mm	275 x 135 x 24
Stückzahl / pcs.	4 x 10
↔ mm	20 x 20 x 10
Stk./g	2 x 2,5



# - DF / DM	421648
↔ ↑ mm	275 x 135 x 30
Stückzahl / pcs.	2 x 4
↔ mm	50 x 50 x 25
Stk./g	2 x 38



# - DF / DM	422361
↔ ↑ mm	275 x 175 x 24
Stückzahl / pcs.	5 x 8
↔ mm	27 x 27 x 13
Stk./g	2 x 6



# - DF / DM	421797
↔ ↑ mm	275 x 135 x 24
Stückzahl / pcs.	6 x 13
↔ mm	14 x 14 x 7
Stk./g	2 x 1



#	421157
↔ ↑ mm	275 x 135 x 30
Stückzahl / pcs.	3 x 7
↔ mm	29,7 x 29,7 x 25
Stk./g	16,8



# - DF / DM	422252
↔ ↑ mm	275 x 175 x 35
Stückzahl / pcs.	8 x 1
↔ mm	59 x 59 x 29
Stk./g	2 x 71



#	421291
↔ ↑ mm	275 x 135 x 40
Stückzahl / pcs.	1 x 14
↔ mm	45 x 45 x 38
Stk./g	44



#	421292
↔ ↑ mm	275 x 135 x 35
Stückzahl / pcs.	3 x 7
↔ mm	35 x 35 x 30
Stk./g	25



# - DF / DM	422022
↔ ↑ mm	275 x 175 x 24
Stückzahl / pcs.	5 x 8
↔ mm	30 x 30 x 15
Stk./g	2 x 9



#	422116
↔ ↑ mm	275 x 175 x 28
Stückzahl / pcs.	4 x 8
↔ mm	29 x 29 x 23
Stk./g	14



# - DF / DM	422251
↔ ↑ mm	275 x 175 x 30
Stückzahl / pcs.	12 x 1
↔ mm	50 x 50 x 25
Stk./g	2 x 40

DE	KUGELN
EN	SPHERES
IT	SFERE
ES	ESFERAS



# - DF / DM	422253
↙↑ mm	275 x 175 x 40
Stückzahl / pcs.	2 x 3
↔ mm	70 x 70 x 35
Stk./g	2 x 113



# - DF / DM	422254
↙↑ mm	275 x 175 x 40
Stückzahl / pcs.	2 x 3
↔ mm	80 x 80 x 40
Stk./g	2 x 162



#	422295
↙↑ mm	275 x 175 x 24
Stückzahl / pcs.	4 x 8
↔ mm	29 x 29 x 21
Stk./g	13



# - DF / DM	421909
↙↑ mm	275 x 135 x 24
Stückzahl / pcs.	3 x 8
↔ mm	25 x 25 x 12,5
Stk./g	2 x 5



#	421867
↙↑ mm	275 x 135 x 30
Stückzahl / pcs.	3 x 8
↔ mm	25,5 x 25,5 x 22,5
Stk./g	9,5



12

DE	BOUCHÉS & BLÖCKE
EN	BOUCHÉS & BLOCS
IT	CIOCCOLATINI RIPIENI E TAVOLETTE
ES	BOMBONES RELLENOS Y BARRAS DE CHOCOLATE



#	421367
↙↑ mm	275 x 135 x 24
Stückzahl / pcs.	1 x 5
↔ mm	117 x 50 x 11
Stk./g	84



#	421421
↙↑ mm	275 x 135 x 24
Stückzahl / pcs.	1 x 3
↔ mm	130 x 79 x 9
Stk./g	105



#	421431
↙↑ mm	275 x 135 x 24
Stückzahl / pcs.	1 x 3
↔ mm	124 x 77 x 11
Stk./g	102

DE	BOUCHÉS & BLÖCKE
EN	BOUCHÉS & BLOCS
IT	CIOCCOLATINI RIPIENI E TAVOLETTE
ES	BOMBONES RELLENOS Y BARRAS DE CHOCOLATE



#	421588
↙↗ mm	275 x 135 x 24
Stückzahl / pcs.	3 x 3
↔ mm	67 x 33 x 5
Stk./g	12



#	421665
↙↗ mm	275 x 135 x 24
Stückzahl / pcs.	1 x 4
↔ mm	118 x 53 x 9,5
Stk./g	61



#	421132
↙↗ mm	275 x 135 x 24
Stückzahl / pcs.	1 x 7
↔ mm	125 x 30 x 13
Stk./g	50

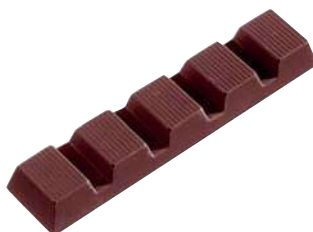

#	421256
↙↗ mm	275 x 135 x 24
Stückzahl / pcs.	1 x 7
↔ mm	128 x 29 x 14
Stk./g	47



#	421611
↙↗ mm	275 x 135 x 24
Stückzahl / pcs.	4 x 2
↔ mm	123 x 22 x 6
Stk./g	16,5



#	421745
↙↗ mm	275 x 135 x 24
Stückzahl / pcs.	2 x 5
↔ mm	63 x 18 x 8
Stk./g	10



#	421667
↙↗ mm	275 x 135 x 24
Stückzahl / pcs.	2 x 2
↔ mm	125 x 55 x 7
Stk./g	47



#	421796
↙↗ mm	275 x 135 x 24
Stückzahl / pcs.	1 x 5
↔ mm	105 x 45 x 7,5
Stk./g	26



#	421854
↙↗ mm	275 x 135 x 24
Stückzahl / pcs.	1 x 8
↔ mm	117,5 x 25 x 14,5
Stk./g	32



#	421872
↙↗ mm	275 x 135 x 24
Stückzahl / pcs.	1 x 8
↔ mm	116,5 x 22,5 x 15
Stk./g	37,7



#	421898
↙↗ mm	275 x 135 x 24
Stückzahl / pcs.	1 x 3
↔ mm	79,5 x 79,5 x 13,5
Stk./g	77,5



#	421899
↙↗ mm	275 x 135 x 24
Stückzahl / pcs.	1 x 8
↔ mm	117,5 x 23,5 x 14
Stk./g	36,5



DE	BOUCHÉS & BLÖCKE
EN	BOUCHÉS & BLOCS
IT	CIOCCOLATINI RIPIENI E TAVOLETTE
ES	BOMBONES RELLENOS Y BARRAS DE CHOCOLATE



#	421612
↔ ↑ mm	275 x 135 x 24
Stückzahl / pcs.	2 x 2
↔ mm	114 x 50 x 8
Stk./g	55



#	421642
↔ ↑ mm	275 x 135 x 24
Stückzahl / pcs.	1 x 2
↔ mm	100 x 100 x 15
Stk./g	92



#	421685
↔ ↑ mm	275 x 135 x 24
Stückzahl / pcs.	1 x 2
↔ mm	100 x 100 x 8
Stk./g	75



#	421769
↔ ↑ mm	275 x 135 x 24
Stückzahl / pcs.	2 x 2
↔ mm	124,5 x 55,5 x 6,5
Stk./g	45



#	422110
↔ ↑ mm	275 x 175 x 24
Stückzahl / pcs.	1 x 3
↔ mm	156 x 77 x 8
Stk./g	90



#	422162
↔ ↑ mm	275 x 175 x 24
Stückzahl / pcs.	1 x 3
↔ mm	155 x 77 x 9
Stk./g	108



#	422276
↔ ↑ mm	275 x 175 x 30
Stückzahl / pcs.	1 x 1
↔ mm	250 x 160 x 25
Stk./g	1000



#	422436
↔ ↑ mm	275 x 175 x 24
Stückzahl / pcs.	1 x 3
↔ mm	156 x 77 x 4
Stk./g	50



#	422437
↔ ↑ mm	275 x 175 x 24
Stückzahl / pcs.	1 x 3
↔ mm	156 x 77 x 5
Stk./g	60



#	422438
↔ ↑ mm	275 x 175 x 24
Stückzahl / pcs.	1 x 3
↔ mm	156 x 77 x 6
Stk./g	70



DE	MEERESFRÜCHTE
EN	SEAFRUIT
IT	FRUTTI DI MARE
ES	MARISCOS



#	421084
↖↗ mm	275 x 135 x 24
Stückzahl / pcs.	3 x 8
↔ mm	35 x 29 x 21
Stk./g	15



#	421170
↖↗ mm	275 x 135 x 24
Stückzahl / pcs.	4 x 7 / 5 Fig.
↔ mm	38 x 20 x 7
Stk./g	4,5



# - DF / DM	421586
↖↗ mm	275 x 135 x 24
Stückzahl / pcs.	22 x 1 / 9 Fig.
↔ mm	unterschiedlich
Stk./g	2 x 6

DE	LOLLIES
EN	LOLLIES
IT	LECCA LECCA
ES	PIRULETAS



#	421294
↖↗ mm	275 x 135 x 24
Stückzahl / pcs.	1 x 10
↔ mm	66 x 35 x 10
Stk./g	16



#	421354
↖↗ mm	275 x 135 x 24
Stückzahl / pcs.	1 x 6
↔ mm	48 x 37 x 15
Stk./g	11



#	421480
↖↗ mm	275 x 135 x 24
Stückzahl / pcs.	1 x 4
↔ mm	54 x 63 x 12
Stk./g	29



#	421623
↖↗ mm	275 x 135 x 24
Stückzahl / pcs.	1 x 4
↔ mm	49,5 x 49,5 x 11
Stk./g	16,5



#		
450900	500 Stk.	



DE	STÄBCHEN AUS PAPPE
EN	STICKS, MADE OF CARDBOARD
IT	BASTONCINI IN CARTONE
ES	PALITOS DE CARTÓN

#	↗ mm		
115548	120	50	



DE	MAGNETFORMEN
EN	MAGNET MOULDS
IT	STAMPI MAGNETICI
ES	MOLDES DE IMÁN

Das Gewicht wurde auf der Grundlage von Vollmilch-Schokolade bestimmt und kann je nach Schokoladensorte, der Füllung sowie der Gießtechnik, Abweichungen verzeichnen.

Il peso viene determinato in base a cioccolato al latte e può subire variazioni secondo il tipo di cioccolato impiegato, il ripieno e la tecnica di fusione.

The weight is based on a moulding with solid milk chocolate and may depend on your chocolate, filling and way of moulding.

El peso queda determinado a base de chocolate con leche entera y puede ser distinto según el tipo de chocolate, relleno y técnica de moldeo.



#	430000
↔ ↑ mm	275 x 135 x 24
Stückzahl / pcs.	3 x 5
↔ mm	35 x 28 x 14
Stk./g	13,5

#	430001
↔ ↑ mm	275 x 135 x 24
Stückzahl / pcs.	4 x 6
↔ mm	24 x 24 x 14
Stk./g	9,5

#	430007
↔ ↑ mm	275 x 135 x 24
Stückzahl / pcs.	3 x 6
↔ mm	32 x 24 x 11
Stk./g	9

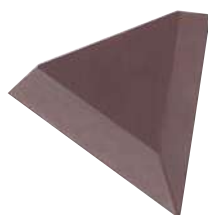

#	430008
↔ ↑ mm	275 x 135 x 24
Stückzahl / pcs.	3 x 4
↔ mm	46 x 40 x 15
Stk./g	13



**Das Edhard-System beinhaltet 3 Hauptkomponenten:  
 Motorblock, Trichter mit Pumpeneinheit und Dosiertülle.**

Edhard Dosiermaschine / Gebäckfüller zum automatischen Befüllen, Dosieren und Dekorieren von Gebäck und Lebensmitteln aller Art wie z.B. Teig, Butter, Käsekuchen, Hüttenkäse, Frischkäse, Sahne, Cremes, Früchtefüllungen, Honig, Glasuren, Gelee, Ketchup, Sirup, Senf, Pudding, Püree, Salat-Dressing, Joghurt und viele andere Produkte.

**This equipment consists of three main components:  
 Power base, filler unit (pump and hopper) and the spouts.**

Automatic dosingmeter for injecting, depositing, layering and topping. A partial list of food products using the dosing systems: Dough, butter, cheesecake, cottage cheese, cream cheese, creams, custard, fruit fillings, honey, icing, jelly, ketchup, molasses, mustard, pudding, purees, salad dressing, yogurt and many other products.



① 1 Set = 1 x # 152600 / 1 x # 152611 / 2 x # 152661

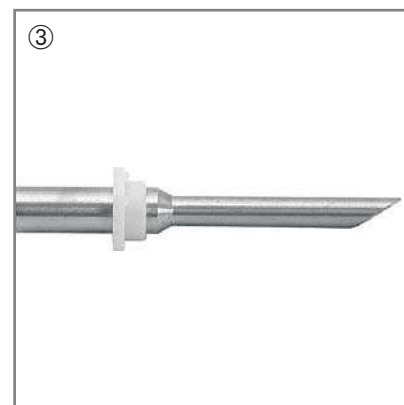

# edhard



INOX

13

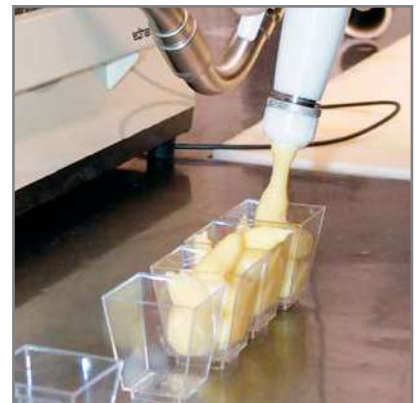



DE	DOSIERMASCHINE "EDHARD"
EN	DOSINGMETER "EDHARD"
IT	DOSATRICE "EDHARD"
ES	DOSIFICADORA "EDHARD"

Zum automatischen Füllen von Croissants, Donuts und Gebäckstücken jeder Art

- Sehr leicht zu bedienen, leicht zu reinigen
- Dosiermenge über digitales Bedienfeld einstellbar
- Kein Tropfen, da gegenläufiger Arbeitsablauf

For stuffing croissant, donuts and all kinds of pastries

- Very simple to use, easy to clean
- Quantity to be dispensed is adjustable with a digital entry keypad from 0 to 99
- No dripping because of reverse motion at end of fill cycle

#	152600	152840	152609	152845
	<b>44 Watt</b>	<b>93 Watt</b>	<b>186 Watt</b>	<b>186 Watt</b>
	Automatischer Zyklus / automatic cycle	Automatischer Zyklus / automatic cycle	Motor mit einstellbarer Geschwindigkeit, Geschwindigkeitskontrolle, Rücklauf und automatischem Zyklus / power base with variable speed, speed control, reverse and automatic cycle	Motor mit einstellbarer Geschwindigkeit, Geschwindigkeitskontrolle, Rücklauf und automatischem Zyklus / power base with variable speed, speed control, reverse and automatic cycle
↔ mm	172 x 391 x 229	241 x 391 x 229	241 x 391 x 229	300 x 400 x 225
	Motor / power base	Motor / power base	Motor / power base	Motor / power base
	220 Volt	240 Volt	240 Volt	240 Volt
 kg	5,5 kg	8,0 kg	8,0 kg	13,3 kg



DE	TRICHTER
EN	FILLER UNITS
IT	TRAMOGGIA
ES	TOLVA-DEPOSITO



#		Ø mm	↑ mm	l	kg
152610	einfach / single	229	381	5,5	1,70
152612	einfach / single	260	502	17,0	2,32
152611	doppelt / double	229	381	5,5	1,70
152613	doppelt / double	260	502	17,0	2,32





93 186	DE	TRICHTER EINFACH
	EN	HOPPERS SINGLE
	IT	TRAMOGGIA A USCITA UNICA
	ES	TOLVA-DEPOSITO UNICA SALIDA

Für # 152850, 152851 und 152856

For # 152850, 152851 und 152856

#		l	kg
152860	einfach / single	5,5	0,6
152861	einfach / single	17,0	1,5



93 186	Material: Edelstahl	Made of stainless steel
	Für # 152850, 152851 und 152856	For # 152850, 152851 und 152856

#		l	kg
152862	einfach / single	17,0	4,3
152865	einfach / single	32,0	5,3

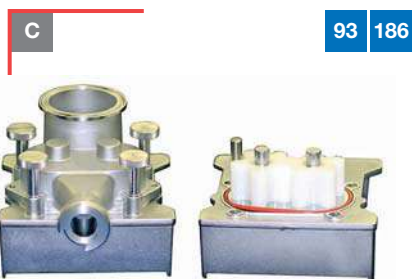

93 186	DE	PUMPEINHEIT AUS EDELSTAHL FÜR FLÜSSIGE PRODUKTE
	EN	PUMP MADE OF STAINLESS STEEL FOR SMOOTH PRODUCTS
	IT	GRUPPO POMPA IN ACCIAIO INOX PER PRODOTTI LIQUIDI
	ES	BOMBA EN INOX PARA PRODUCTOS LÍQUIDOS

#		kg
152850	Pumpeinheit einfach / pump single	3,8

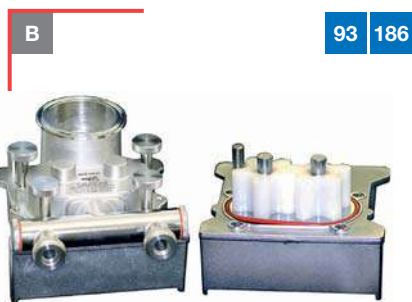

93 186	DE	PUMPEINHEIT AUS EDELSTAHL FÜR FLÜSSIGE PRODUKTE
	EN	PUMP MADE OF STAINLESS STEEL FOR SMOOTH PRODUCTS
	IT	GRUPPO POMPA IN ACCIAIO INOX PER PRODOTTI LIQUIDI
	ES	BOMBA EN INOX PARA PRODUCTOS LÍQUIDOS

#		kg
152856	Pumpeinheit doppelt / pump double	4,2

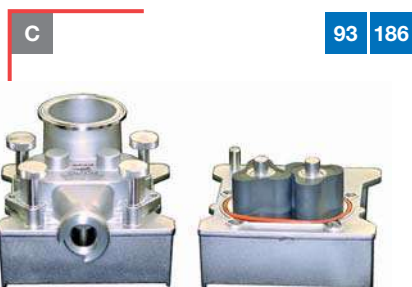

93 186	DE	PUMPEINHEIT AUS EDELSTAHL FÜR PRODUKTE MIT TEILCHEN
	EN	PUMP MADE OF STAINLESS STEEL FOR PRODUCTS WITH PARTICLES
	IT	GRUPPO POMPA IN ACCIAIO INOX PER PRODOTTI GRANULOSI
	ES	BOMBA EN INOX PARA PRODUCTOS CON TROCITOS SÓLIDOS

Für Teilchen max. 10 mm

For particles of max. 10 mm

#		kg
152851	Pumpeinheit einfach / pump single	4,0



DE	KUPPLUNGSSTÜCK FÜR TRICHTER EINFACH
EN	ADAPTER FOR SINGLE FILLER UNITS
IT	ADATTATORE A DOPPIA USCITA PER TRAMOGGIA
ES	ADAPTADOR CON DOBLE SALIDA PARA TOLVA

Zur Verwendung von „2-fach“ Tüllen bei einfachen Trichtern

For using "double spouts" for single filler units

#	Kupplungsstück / adapter	für / for #
152699		152610, 152612, 152850, 152851



DE	TÜLLEN-ADAPTER
EN	EXTERNAL PIPING TUBE ADAPTER
IT	ADATTATORE PER BOCCHETTE
ES	ADAPTADOR PARA BOQUILLAS

Für Verlängerungsschlauch # 152677

for hose assembly # 152677

#	Ø mm
152710	24
152711	30
152712	35





















DE	ZUBEHÖR FÜR DOSIERMASCHINE "EDHARD"
EN	ACCESSORY FOR DOSINGMETER "EDHARD"
IT	ACCESSORIO PER DOSATRICE "EDHARD"
ES	ACCESORIO PARA DOSIFICADORA "EDHARD"

#	Fußpedal / Switch foot
152679	



DE	ZUBEHÖR FÜR DOSIERMASCHINE "EDHARD" PASSEND FÜR TRICHTER 152611, 152613, 152856
EN	ACCESSORIES FOR DOSINGMETER "EDHARD" USABLE FOR FILLER UNITS 152611, 152613, 152856
IT	ACCESSORI "EDHARD" PER TRAMOGGE 152611, 152613, 152856
ES	ACCESORIOS "EDHARD" PARA TOLVAS 152611, 152613, 152856

#		Ø mm	↗ mm
 152630	 Tülle, doppelt / Spout double	11,1	89
 152631	 Konfitüre-Tülle, doppelt / Jam spout, double	11	82,5
 152632	 Tülle glatt, doppelt / Spout plain, double	4,8	41
 152652	 Tülle geschlitzt, doppelt / Spout eclair-slit, double	11,1	127
 152653	 Tülle, doppelt / Spout, double	11,1	127
 152657	 Tülle glatt, doppelt / Spout plain, double	7,9	111,1
 152659	 Tülle geschlitzt, doppelt / Spout eclair-slit, double	7,9	111,2
 152661	 Tülle glatt 30° doppelt / Spout plain 30° double	7,1	57
 152666	 Berlinertülle, doppelt / Spout "Krapfen", double	6,4	41,3

DE	ZUBEHÖR FÜR DOSIERMASCHINE "EDHARD" PASSEND FÜR TRICHTER 152610, 152612, 152850, 152851
EN	ACCESSORIES FOR DOSINGMETER "EDHARD" USABLE FOR FILLER UNITS 152610, 152612, 152850, 152851
IT	ACCESSORI "EDHARD" PER TRAMOGGE 152610, 152612, 152850, 152851
ES	ACCESORIOS "EDHARD" PARA TOLVAS 152610, 152612, 152850, 152851

#		Ø mm	↗ mm	→ mm	
---	--	------	------	------	--

▶A ▶C					
	152633	Tülle glatt, einfach / Spout plain, single	22,2	57	

▶A ▶C					
	152635	Tülle glatt, einfach / Spout plain, single	22,2	89	

▶A ▶C					
	152636	Tülle glatt, einfach / Spout plain, single	22,2	127	

▶A ▶C					
	152638	Bandtülle / Layering spout		101	7,1
	152639	Bandtülle / Layering spout		89	4,8
	152640	Bandtülle / Layering spout		40	4
	152641	Bandtülle / Layering spout		40	2
	152642	Bandtülle / Layering spout		60	3
	152643	Bandtülle / Layering spout		50	2,5
	152644	Bandtülle / Layering spout		70	3
	152645	Bandtülle / Layering spout		80	2,5
152646	Bandtülle / Layering spout		30	3,6	







▶A ▶C					
	152647	Tülle einfach 45° / Spout single 45°	22,2	120,6	

▶A ▶C					
	152648	Dreifach-Tülle einfach / Spout triple single	4,8 x 3	25	3

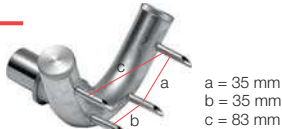
▶A ▶C					
	152654	Tülle glatt, einfach / Spout plain, single	22,2	177,8	3

▶A ▶C					
	152880	Donut-Füller / Donut spout	88	H: 30	

DE	ZUBEHÖR FÜR DOSIERMASCHINE "EDHARD" PASSEND FÜR TRICHTER 152610, 152612, 152850, 152851
EN	ACCESSORIES FOR DOSINGMETER "EDHARD" USABLE FOR FILLER UNITS 152610, 152612, 152850, 152851
IT	ACCESSORI "EDHARD" PER TRAMOGGE 152610, 152612, 152850, 152851
ES	ACCESORIOS "EDHARD" PARA TOLVAS 152610, 152612, 152850, 152851

#		Ø mm	↗ mm	→ mm	
▶A ▶C					
152655	Tülle geschlitzt, einfach / Spout slit, single	22,2	111,2		
▶A ▶C					
152656	Croissant-Füller einfach / Croissant spout, single	4,8 x 4	25	4	
▶A ▶C					
152658	Tülle geschlitzt, einfach / Spout slit, single	22,2	127		
▶A ▶C					
152660	Tülle "Cannoli" einfach / Spout "Cannoli" single	14,3	76,2		
▶A ▶C					
152662	Tülle glatt, einfach / Spout plain, single	22,2	41		
▶A ▶C					
152663	Tülle Blaubeeren, einfach / Spout blueberry, single	22,2	82,5		
▶A ▶C					
152664	Tülle glatt, einfach / Spout plain, single	22,2	111,2		
▶A ▶C					
152665	Univers. Verläng., einf. / Univers. extension, single	22,2	158,7		

DE	ZUBEHÖR FÜR DOSIERMASCHINE "EDHARD" PASSEND FÜR TRICHTER 152610, 152612, 152850, 152851
EN	ACCESSORIES FOR DOSINGMETER "EDHARD" USABLE FOR FILLER UNITS 152610, 152612, 152850, 152851
IT	ACCESSORI "EDHARD" PER TRAMOGGE 152610, 152612, 152850, 152851
ES	ACCESORIOS "EDHARD" PARA TOLVAS 152610, 152612, 152850, 152851

#		Ø mm	↗ mm		
---	--	------	------	--	--

▶A▶C



152677	Verlängerung (Schlauch) / Hose assembly	22,2	914		
--------	---	------	-----	--	--

DE	AUSGLEICHSVORRICHTUNG
EN	BALANCER
IT	BILANCIAMENTO
ES	BALANCEADOR







Halterung für Edhard Schlauchsystem,  
integrierte Zugvorrichtung.

Holder for Edhard hose, integrated traction  
device.

#	↔ mm	
152898	380 x 410 x 135	



DE	ZUBEHÖR FÜR DOSIERMASCHINE "EDHARD"
EN	ACCESSORIES FOR DOSINGMETER "EDHARD"
IT	ACCESSORI PER DOSATRICI "EDHARD"
ES	ACCESORIOS PARA DOSIFICADORAS EDHARD

#		für / for #	Ø mm	
	152637	Ansatzstück für Art-Nr. / Double spout for code	# 152665	19
	152667	Anti-Tropfröhre für Art-Nr. / Dripless valve for code	# 152649, 152650, 152651	
	152668	Anti-Tropfröhre für Art-Nr. / Dripless valve for code	# 152649, 152650, 152651	
	152669	Anti-Tropfröhre für Art-Nr. / Dripless valve for code	# 152665, 152677	
	152670	Anti-Tropfröhre für Art-Nr. / Dripless valve for code	# 152665, 152677	
	152671	Dekortülle für Art-Nr. / Decor tube for code	# 152665, 152677	9,7
	152672	Dekortülle für Art-Nr. / Decor tube for code	# 152665, 152677	14
	152673	Dekortülle für Art-Nr. / Decor tube for code	# 152665, 152677	14,2
	152674	Dekortülle für Art-Nr. / Decor tube for code	# 152665, 152677	4,8 x 9,7
	152675	Dekortülle für Art-Nr. / Decor tube for code	# 152665, 152677	12
	152676	Dekortülle für Art-Nr. / Decor tube for code	# 152665, 152677	9,7

DE	GEBÄCKFÜLLER
EN	CREAM INJECTOR
IT	RIEMPITRICE PER CREME
ES	INYECTORA

- Zum Füllen von Krapfen, Pfannkuchen und anderen Patisserie-Produkten mit max. Geschwindigkeit und Genauigkeit
- Gehäuse aus Aluminiumguß
- Trichter, Zylinder, Dosierer, Welle, Hebel und Auslaufrohr aus rostfreiem Edelstahl
- For filling "Krapfen", pancakes and other sweets with maximum speed and precision
- Base made of cast aluminium
- Funnel, cylinder, piston, injector, lever and thrust rib are made of stainless steel

#### KLEIN

Technische Daten:

Auslaufrohr Ø:	2,4 mm
Dosiermenge:	1 – 30 g
Einfüllmenge:	2,0 l

#### SMALL

Technical specification:

Piston Ø:	2,4 mm
Dosis:	1 – 30 g
Funnel:	2.0 l



#	↑ mm	→ mm	⚖ kg
153000	440	250	2,70

#### GROSS

Technische Daten:

Auslaufrohr Ø:	3,1 mm;
Dosiermenge:	1 – 60 g
Einfüllmenge:	5,2 l

#### LARGE

Technical specification:

Piston Ø:	3,1 mm
Dosis:	1 – 60 g
Funnel:	5.2 l



#	↑ mm	→ mm	⚖ kg
153001	520	370	7,20

DE	GEBÄCKSPRITZE
EN	BISCUIT / PASTRY SYRINGE
IT	SIRINGA PER PASTICCERIA
ES	JERINGA PARA PASTELERÍA

- Korpus, Gebäckspritze, Griff und Füße aus Aluminium
- Inklusive 13 Scheiben für unterschiedliche Spritzgebäckarten
- Body, fittings, pastry presses, handle and bracket made of aluminium
- Including 13 different pastry presses for various shapes of biscuit pastry

#	↔ mm	⚖ kg
152700	500 x 200 x 190	5,0





# 151236  
Donut-Aufsatz / Donut adapter

DE GEBÄCKFÜLLER  
EN CREAM INJECTOR  
IT RIEMPITRICE PER CREME  
ES INYECTORA PARA CREMAS



- Füllkolben und Schüssel aus Edelstahl
- Inklusive 2 Deckel
- Dosiermenge regulierbar: 0 – 15 g
- Jedes Bauteil ist einfach zu reinigen
- Pistons and bowl made of stainless steel
- Including 2 lids
- Dosing adjustable: 0 – 15 g
- All components are easy to clean

Ø (mm)	80
Ø Nadel / needle (mm)	2
Höhe Nadel / Height needle (mm)	15
Abstand Nadel / Distance needle (mm)	20
Anzahl / quantity	8

#		↔ mm	⚖ kg	🗄 l
152200	2 Füllkolben / 2 pistons	260 x 380 x 350	2,1	3,0
152230	1 Füllkolben / 1 piston	260 x 380 x 350	2,0	3,0
152235	mit Donut-Füllkolben / with donut filler spout	260 x 380 x 350	2,0	3,0
152210	Ersatzschüssel / bowl		-	3,0



# 152230



# 152200



# 152235





DE	HEBEL DOSIERSPENDER MIT DONUT-AUFSATZ
EN	LEVER DISPENSER WITH DONUT ADAPTER
IT	DOSATORE A LEVA CON ATTACCO PER CIAMBELLA
ES	DOSIFICADOR DE PALANCA CON ACCESORIO PARA DONUTS

Material: Edelstahl

• **Beheizbar**

- Temperatur einstellbar: 0 – 120 °C
- Spannung: 230 V, 50 Hz
- Leistung: 900 W
- Dosierung einstellbar / ± 35 ml

**Achtung: Wasserbad-Funktion**

Made of stainless steel

• **Heatable**

- Temperature adjustable: 0 – 120 °C
- Voltage: 230 V, 50 Hz
- Power: 900 W
- Dosage adjustable / ± 35 ml

**Attention: Bain-Marie Function**

#	↔ mm	⚖ kg	📏 l
152260	180 x 180 x 510	3,8	3,0

Material: Edelstahl

- Dosierung einstellbar / ± 35 ml

Made of stainless steel

- Dosage adjustable / ± 35 ml

#	↔ mm	⚖ kg	📏 l
152280	180 x 180 x 460	2,3	4,5



# 151238

Donut-Aufsatz / Donut adapter

Ø (mm)	75
Ø Nadel / needle (mm)	3
Höhe Nadel / Height needle (mm)	20
Abstand Nadel / Distance needle (mm)	20
Anzahl / quantity	8



13



DE	FLASCHENWÄRMER, ELEKTRISCH
EN	BOTTLE WARMER, ELECTRIC
IT	SCALDAFLACONI DOSATORI
ES	CALIENTA BIBERONES

- Außengehäuse Edelstahl
  - Temperatur stufenlos regelbar (40–90°C)
  - Kein Wasserbad – Temperatureaustausch erfolgt über Direktkontakt / Luft
  - Geringer Energieverbrauch
  - Inklusive Quetschflasche (950 ml) aus PP
  - Öffnungsdurchmesser: 86 mm
  - Öffnungstiefe: 195 mm
- Outer casing stainless steel
  - Temperature infinitely variable (40–90°C)
  - No bain marie – temperature exchange via direct contact / air
  - Low energy consumption
  - Including squeeze bottle (950 ml) made of PP
  - Opening diameter: 86 mm
  - Opening depth: 195 mm



# 150620



# 150630



# 150635

#	150620	150630	150635
	Flaschenwärmer 1-fach	Flaschenwärmer 2-fach	Flaschenwärmer 3-fach
	Außengehäuse Edelstahl	Außengehäuse Edelstahl	Außengehäuse Edelstahl
Zubehör	Quetschflasche 1 x 950 ml	Quetschflasche 2 x 950 ml	Quetschflasche 3 x 950 ml
→ mm	210	305	445
↓ mm	165	165	165
↑ mm	330	330	330
🔌	200 W 50 / 60 Hz / 230 Volt	400 W 50 / 60 Hz / 230 Volt	600 W 50 / 60 Hz / 230 Volt
°C	40° bis 90°C	40° bis 90°C	40° bis 90°C

DE	QUETSCHFLASCHEN
EN	SQUEEZE BOTTLES
IT	FLACONI DOSATORI
ES	DISPENSADORES A PRESIÓN – BIBERONES

Material: PP

Made of PP

#	Öffnung / mouth	↑ mm	g	Ø mm	ml
150625	1 ○	281	85	80	950
150621	3 ○	291	74	80	950

200490	1 ○	195	30	52	250
200491	1 ○	240	42	62	500
200492	1 ○	265	61	72	750
200493	1 ●	240	42	62	500
200494	1 ●	265	61	72	750
200495	1 ●	240	42	62	500
200496	1 ●	265	61	72	750



# 150625

# 150621



DE	DOSIERSYSTEM
EN	SAUCE DISPENSER
IT	DOSATORE
ES	DISPENSADOR

Für alle Arten von Saucen, Senf, Ketchup, Mayonnaise

- Material: PP
- Zur Befestigung am Bügel
- Behälter inklusive Einhand-Dosierspender

For all kinds of sauces, mustard, ketchup, mayonnaise

- Made of PP
- For mounting on the bracket
- Container including one-hand dispenser

#	↔ mm	l
152970	170 x 170 x 330 mm	5,5

#	Zubehör / Accessories
152971	Aufhängekette / Chain
152972	Wandhaken / Wall hook





# 152410

DE	DRUCKKNOPF DOSIERSPENDER MIT GN BEHÄLTER
EN	PUMP DISPENSERS WITH GN CONTAINER
IT	DOSATORI A PRESSIONE CON CONTENITORE GN
ES	DOSIFICADORES CON CONTENEDOR GN

Material: Edelstahl  
 • GN 1/6 Behälter inklusive  
 • Dosierung einstellbar / ± 30 ml

Made of stainless steel  
 • GN 1/6 container included  
 • Dosage adjustable / ± 30 ml

#	↔ mm	↑ mm	⬇ l
152410 ●	180 x 165	320	3,0
152541 ○	180 x 165	320	3,0
152542 ●	180 x 165	320	3,0
152411	180 x 340	340	2 x 3,0
152412	180 x 500	340	3 x 3,0



# 152411



# 152412

DE	DRUCKKNOPF DOSIERSPENDER MIT GN BEHÄLTER "COOL"
EN	PUMP DISPENSERS WITH GN CONTAINER "COOL"
IT	DOSATORI A PRESSIONE CON CONTENITORE GN "COOL"
ES	DOSIFICADORES CON CONTENEDOR GN "COOL"

Material: Edelstahl  
 • GN 1/6 Behälter inklusive  
 • Dosierung einstellbar / ± 30 ml  
 • Lieferumfang **ohne** Kühlakkus

Made of stainless steel  
 • GN 1/6 container included  
 • Dosage adjustable / ± 30 ml  
 • Cooling packs are **not** included



# 152441

#	↔ mm	↑ mm	⬇ l
152441	185 x 425	375	2 x 3,0
152442	185 x 585	375	3 x 3,0



# 152442

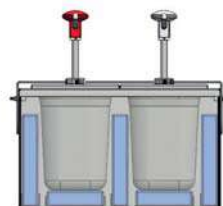

für bis zu 5 Kühlakkus  
(GN 1/9) / for up to  
5 cooling packs (GN 1/9)

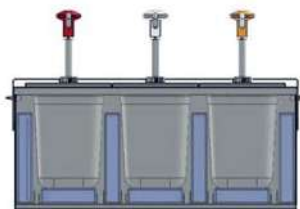

für bis zu 7 Kühlakkus  
(GN 1/9) / for up to  
7 cooling packs (GN 1/9)

Passende Kühlakkus

Suitable cooling packs



- 3°C
- 12°C
- 21°C

#	GN	↔ mm	⚖ g
281001	1/9	176 x 108 x 30	500
281006	1/9	176 x 108 x 30	500
281011	1/9	176 x 108 x 30	500

DE	DRUCKKNOPF DOSIERSPENDER
EN	PUMP DISPENSERS
IT	DOSATORI A PRESSIONE
ES	DOSIFICADORES

Material: Edelstahl

- Dosierung einstellbar / ± 30 ml

Made of stainless steel

- Dosage adjustable / ± 30 ml

#	↔ mm	↑ mm	⊕ l
152420 ●	∅: 120	380	2,0
152543 ○	∅: 120	380	2,0
152544 ●	∅: 120	380	2,0
152421	140 x 290	410	2 x 2,0
152422	140 x 440	410	3 x 2,0



# 152420



# 152421



# 152422

DE	DRUCKKNOPF DOSIERSPENDER MIT SICHTFENSTER
EN	PUMP DISPENSERS WITH GLASS WINDOW
IT	DOSATORI A PRESSIONE CON FINESTRELLA
ES	DOSIFICADORES CON VISOR DE CONTENIDO

Material: Edelstahl

- Dosierung einstellbar / ± 30 ml

Made of stainless steel

- Dosage adjustable / ± 30 ml

#	↔ mm	↑ mm	⊕ l
152430 ●	∅: 100	455	2,0
152545 ○	∅: 100	455	2,0
152547 ●	∅: 100	455	2,0
152431	140 x 290	470	2 x 2,0
152432	140 x 440	470	3 x 2,0



# 152431



# 152432

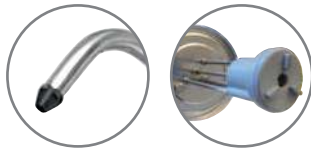

DE	HEBEL DOSIERSPENDER
EN	LEVER DISPENSERS
IT	DOSATORI A LEVA
ES	DOSIFICADORES DE PALANCA

- Material: Edelstahl
- Auslauf schwenkbar
  - Antitropftülle
  - Dosierung einstellbar / ± 35 ml

- Made of stainless steel
- Swivel spout
  - Anti-drip nozzle
  - Dosage adjustable / ± 35 ml



# 152403

#	↔ mm	↑ mm	Ø mm	⌘	
152400	-	420	180	4,5	
152401	200 x 400	440	180	2 x 4,5	
152402	200 x 600	440	180	3 x 4,5	
152403	-	380	180	3,0	
152450	-	420	260	10,0	
152453	Ersatzbehälter / Spare container # 152400		180	4,5	
152452	Ersatzbehälter / Spare container # 152450		260	10,0	
152454	geschlossener Deckel / closed lid # 152400		180	4,5	
152455	geschlossener Deckel / closed lid # 152450		260	10,0	



# 152400



# 152401



# 152454 + 152455



# 152450



# 152402

DE	HEBEL DOSIERSPENDER
EN	LEVER DISPENSERS
IT	DOSATORI A LEVA
ES	DOSIFICADORES DE PALANCA

Material: Edelstahl

- Lieferumfang **ohne** GN Behälter
- Geeignet für Behälter mit einer von Tiefe 200 mm
- Auslauf schwenkbar
- Antitropftülle
- Dosierung einstellbar / ± 35 ml

Made of stainless steel

- GN containers are **not** included
- Suitable for containers with a depth of 200 mm
- Swivel spout
- Anti-drip nozzle
- Dosage adjustable / ± 35 ml



# 152416

#	↔ mm	↑ mm	GN	⚖ l
152413	330 x 165	380	1/3	7,0
152414	270 x 165	380	1/4	5,0
152416	180 x 165	380	1/6	3,0
152417	330 x 270	380	1/2	10,0

Anwendungsbeispiel /  
Application example



# 152413



# 152414



# 152417

DE	HEBEL DOSIERSPENDER "COOL"
EN	LEVER DISPENSERS "COOL"
IT	DOSATORI A LEVA "COOL"
ES	DOSIFICADORES DE PALANCA "COOL"

Material: Edelstahl

- GN 1/6 Behälter inklusive
- Dosierung einstellbar / ± 35 ml
- Lieferumfang **ohne** Kühlakkus

Made of stainless steel

- GN 1/6 container included
- Dosage adjustable / ± 35 ml
- Cooling packs are **not** included



# 152418

#	↔ mm	↑ mm	⚖ l
152418	185 x 425	375	2 x 3,0
152419	185 x 585	375	3 x 3,0

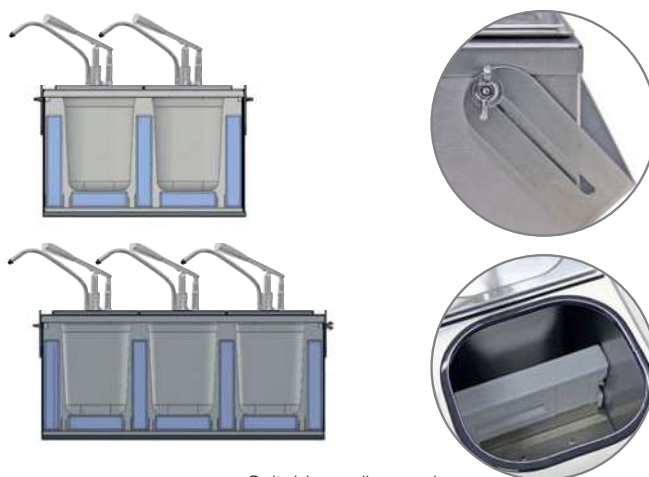

# 152419

Passende Kühlakkus

Suitable cooling packs

#	GN	↔ mm	⚖ g
281001	1/9	176 x 108 x 30	500
281006	1/9	176 x 108 x 30	500
281011	1/9	176 x 108 x 30	500



- 3°C
- 12°C
- 21°C







DE	DRUCKKNOPF DOSIERSPENDER
EN	PUMP DISPENSERS
IT	DOSATORI A PRESSIONE
ES	DOSIFICADORES

- Druckknopf-Bedienung
- Schwenkbar
- Spülmaschinengeeignet
- Push-button operation
- Swivelling
- Dishwasher safe

**Deckel: Kunststoff (PE)**

**Lid made of PE**

#		↗ mm	→ mm	↑ mm	♻️ l
154710	□	175	140	150*	2,0
154711	□	175	140	210*	3,0
154712	□	175	140	340*	5,0

\* Höheangabe ohne Pumpe / Height without pump

📌 Behälter auch separat erhältlich – siehe Seite 133. / Container also available separately – see page 133.



**Deckel: Edelstahl**

**Lid made of stainless steel**

#		↗ mm	→ mm	↑ mm	♻️ l
154720	□	175	140	150*	2,0
154721	□	175	140	210*	3,0
154722	□	175	140	340*	5,0

\* Höheangabe ohne Pumpe / Height without pump



- Druckknopf-Bedienung, schwenkbar
- Spülmaschinengeeignet
- Hub: 30 ml
- Unterbehälter: PS, transparent



- Push-button operation, swivelling
- Dishwasher safe
- Dosage: 30 ml
- Container: PS, transparent

#		↗ mm	→ mm	↑ mm	♻️ ml
152922	○	120	120	130	1000
152923	○	120	120	175	1400
152924	○	120	120	265	2200
152932	□	110	110	130	1000
152933	□	110	110	175	1400
152934	□	110	110	265	2200

\* Höheangabe ohne Pumpe / Height without pump

📌 Behälter auch separat erhältlich – siehe Seite 133. / Container also available separately – see page 133.

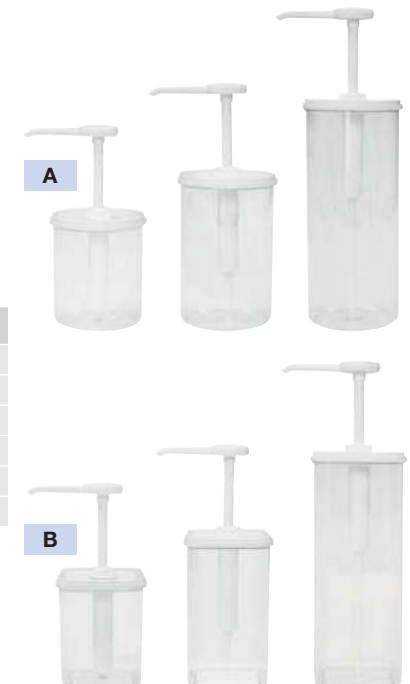

DE	STÄNDER FÜR DRUCKKNOPF-DOSIERSPENDER
EN	STAND FOR PUMP DISPENSERS
IT	SUPPORTO PER DOSATORI A PRESSIONE
ES	SOPORTE PARA DOSIFICADORES

Material: Edelstahl  
(Dosierspender nicht im Lieferumfang enthalten)

Made of stainless steel  
(Dosing dispenser not included)

	#		↗ mm	→ mm	↑ mm
A	152990	○	400	130	100
B	152991	□	400	130	100

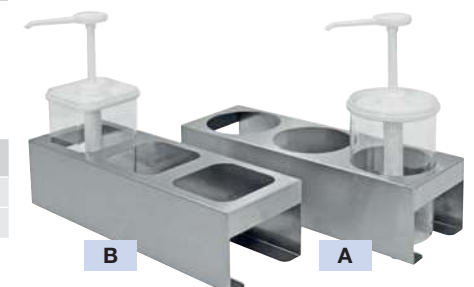



Anwendungsbeispiel /  
Application example



DE	GEBÄCKFÜLLER – GEBOGEN 180°
EN	CREAM DISPENSER – CURVED 180°
IT	DOSATORE PER CREME – CURVO 180°
ES	DOSIFICADOR DE CREMA – CURVADO 180°

Passend für ca. 3 kg Eimer  
Brotaufstrich (Nuss-Nougat-Creme)

- Material: Edelstahl
- Hebelbedienung
- Auslauf schwenkbar
- Extra dicker Auslauf
- Separate Dosiertülle inklusive
- Dosiermenge einstellbar / ± 35 ml

Suitable for approx. 3 kg bucket of sandwich spread (nut nougat cream)

- Made of stainless steel
- Lever operation
- Swivel spout
- Extra thick spout
- Separate dosing nozzle included
- Dosing adjustable / ± 35 ml

#	↑ mm	Ø mm	↕ l
152482	390	255	3,0



DE	WARMHALTEGERÄT – BEHEIZBAR	
EN	WARMING DEVICE – HEATABLE	
IT	DOSATORE A LEVA – RISCALDATO	
ES	DOSIFICADOR – CALEFACTABLE	

- Speziell für warme Saucen
- Material: Edelstahl
  - Hebelbedienung
  - GN 1/6 Behälter – 200 mm
  - Temperatur einstellbar: 30 – 90 °C
  - Anzeige mit Kontrollleuchte
  - Spannung: 230 V, 50 Hz
  - Leistung: 900 W
  - Auslauf schwenkbar
  - Antitropftülle
  - Dosierung einstellbar / ± 35 ml

**Achtung: Wasserbad-Funktion**

- Especially for warm sauces
- Made of stainless steel
  - Lever operation
  - GN 1/6 container – 200 mm
  - Temperature adjustable: 30 – 90 °C
  - Display with control light
  - Voltage: 230 V, 50 Hz
  - Power: 900 W
  - Swivel spout
  - Anti-drip nozzle
  - Dosage adjustable / ± 35 ml

**Attention: Bain-Marie Function**

#	↑ mm	↔ mm	↕ l
152456	510	<b>GN 1/6 – 290 x 230</b>	3,0



DE	HEBELDOSIERSPENDER – BEHEIZBAR	
EN	LEVER DISPENSERS – HEATABLE	
IT	DOSATORE A LEVA – RISCALDATO	
ES	DOSIFICADOR DE PALANCA – CALEFACTABLE	

Speziell für Kuvertüren, Suppen, Saucen und Dips

- Material: Edelstahl
- Hebelbedienung
- Temperatur einstellbar: 0 – 120 °C
- Anzeige mit Kontrollleuchte
- Spannung: 230 V, 50 Hz
- Leistung: 900 W
- Auslauf schwenkbar
- Antitropftülle
- Dosierung einstellbar / ± 35 ml

**Achtung: Wasserbad-Funktion**

Especially for couvertures, soups, sauces and dips

- Made of stainless steel
- Lever operation
- Temperature adjustable: 0 – 120 °C
- Display with control light
- Voltage: 230 V, 50 Hz
- Power: 900 W
- Swivel spout
- Anti-drip nozzle
- Dosage adjustable / ± 35 ml

**Attention: Bain-Marie Function**

#	↑ mm	Ø mm	↕ l
152470	510	180	3,0

DE	GEBÄCKFÜLLER
EN	CREAM DISPENSERS
IT	DOSATORI PER CREME
ES	DOSIFICADORES DE CREMA

Speziell für Krapfen, Croissants und andere Gebäckarten

- Material: Edelstahl
- Hebelbedienung
- Dosierung einstellbar / ± 35 ml

Especially for doughnuts, croissants and other pastries

- Made of stainless steel
- Lever operation
- Dosage adjustable / ± 35 ml

#	↑ mm	Ø mm	⊕ I
152480	460	180	4,5
152481	470	180	4,5
152493	460	260	10,0



# 152481

# 152493

DE	GEBÄCKFÜLLER – BEHEIZBAR
EN	CREAM DISPENSER – HEATABLE
IT	DOSATORE PER CREME – RISCALDATO
ES	DOSIFICADOR DE CREMA – CALEFACTABLE



Speziell für Kuvertüren, Schokolade, Nougatcreme, Vanillecreme

- Material: Edelstahl
- Hebelbedienung
- Temperatur einstellbar: 0 – 120 °C
- Anzeige mit Kontrollleuchte
- Spannung: 230 V, 50 Hz
- Leistung: 900 W
- Dosierung einstellbar / ± 35 ml

**Achtung: Wasserbad-Funktion**

Especially for couvertures, chocolate, nougat cream, vanilla cream

- Made of stainless steel
- Lever operation
- Temperature adjustable: 0 – 120 °C
- Display with control light
- Voltage: 230 V, 50 Hz
- Power: 900 W
- Dosage adjustable / ± 35 ml

**Attention: Bain-Marie Function**

#	↑ mm	Ø mm	⊕ I
152460	510	180	3,0



DE	HILFSWERKZEUG FÜR HEBEL DOSIERSPENDER
EN	WRENCH FOR LEVER DISPENSERS
IT	CHIAVE PER DOSATORI A LEVA
ES	LLAVE PARA DOSIFICADORES CON PALANCA

• Für optimales Öffnen und Verschließen des Kolbens aller Hebeldosierspender

• For optimal opening and closing of the piston of all lever dispensers

#	
152305	für / for 152400, 152401, 152402, 152403, 152450, 152413, 152414, 152416, 152417, 152418, 152419, 152490, 152492, 152482, 152456, 152470, 152480, 152481, 152493, 152460





Größenangaben und Kombinationsbeispiele /  
 Sizes and combination examples

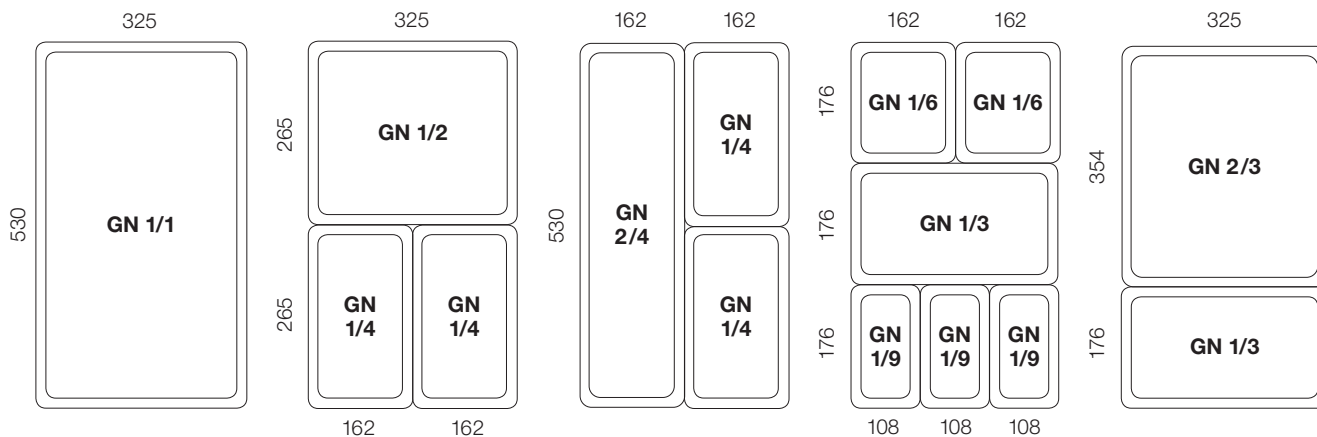

PC

DE GN-BEHÄLTER  
 AUS POLYCARBONAT

---

EN GN-CONTAINERS  
 MADE OF POLYCARBONATE

---

IT CONTENITORI GN  
 IN POLICARBONATO

---

ES CONTENEDORES IN  
 GASTRONORM POLICARBONATO

Material: Polycarbonat (PC).  
 Ideal zum Lagern und Aufbewahren aller  
 Lebensmittel. Einsetzbar von - 40°C bis  
 ca. + 110 °C, Liter-Skalierung an der Seite.  
 Robust, formstabil und stapelbar.

Made of polycarbonate (PC). Ideal for  
 storing and keeping all kinds of food.  
 Withstands temperatures from - 40°C up  
 to ca. + 110 °C, litre scale on the side.  
 Durable, will not bend or dent, stable  
 and stackable.

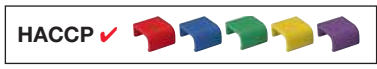

PP

DE GN-BEHÄLTER  
 AUS POLYPROPYLEN

---

EN GN-CONTAINERS  
 MADE OF POLYPROPYLENE

---

IT CONTENITORI GN  
 IN POLIPROPILENE

---

ES CONTENEDORES GASTRONORM  
 POLIPROPILENO

Material: Polypropylen (PP).  
 Ideal zum Lagern und Aufbewahren aller  
 Lebensmittel. Einsetzbar von - 40 °C bis  
 ca. + 80 °C, Liter-Skalierung an der Seite.  
 Robust, formstabil und stapelbar.

Made of polypropylene (PP). Ideal for  
 storing and keeping all kinds of food.  
 Withstands temperatures from - 40 °C up  
 to ca. + 80 °C, litre scale on the side.  
 Durable, will not bend or dent, stable  
 and stackable.



SST

DE GN-BEHÄLTER  
 AUS EDELSTAHL

---

EN GN-CONTAINERS  
 MADE OF STAINLESS STEEL

---

IT CONTENITORI GN  
 IN ACCIAIO INOX

---

ES CONTENEDORES GASTRONORM  
 ACERO INOXIDABLE

Aus rostfreiem Chrom-Nickel-Edelstahl  
 18 /10, schwere Qualität, mit elektrolytisch  
 polierter Oberfläche für den professionellen  
 Einsatz.

Made of stainless steel 18 /10,  
 heavy quality, surface electrolytically  
 polished for professional use.

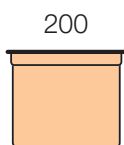
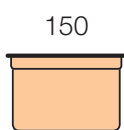
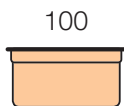
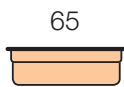
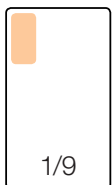
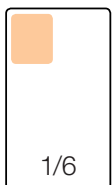
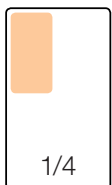
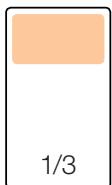
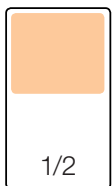
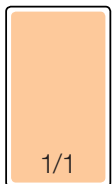
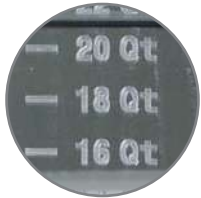

**DE** GN BEHÄLTER AUS POLYCARBONAT  
**EN** GN CONTAINERS MADE OF POLYCARBONATE  
**IT** CONTENITORI GN IN POLICARBONATO  
**ES** CONTENEDORES IN GASTRONORM POLICARBONATO



PC

#	GN	↑ mm	⬇ mm	
530100	1/1	65	9,0	
530101	1/1	100	13,3	
530102	1/1	150	20,0	
530103	1/1	200	26,4	
530110	1/2	65	4,0	
530111	1/2	100	6,1	
530112	1/2	150	9,0	
530113	1/2	200	11,9	
530120	1/3	65	2,5	
530121	1/3	100	3,8	
530122	1/3	150	5,5	
530123	1/3	200	7,1	
530130	1/4	65	1,7	
530131	1/4	100	2,6	
530132	1/4	150	3,8	
530133	1/4	200	4,8	
530140	1/6	65	1,0	
530141	1/6	100	1,6	
530142	1/6	150	2,3	
530143	1/6	200	2,8	
530150	1/9	65	0,6	
530151	1/9	100	0,9	

DE	GN DECKEL	
GB	GN LID	 <span style="border: 1px solid black; padding: 2px;">PC</span>
IT	COPERCHIO GN	
ES	TAPA GN	

- Ausführung: aufliegender Deckel
- Design: surface mounted lid



#	GN	
530105	1/1	
530115	1/2	
530125	1/3	
530135	1/4	
530145*	1/6	
530155*	1/9	

\* ohne Griff / without handle

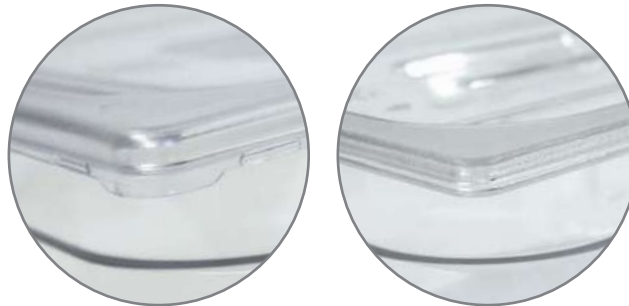

DE	GN DECKEL	
EN	GN LID	 <span style="border: 1px solid black; padding: 2px;">PC</span>
IT	COPERCHIO GN	
ES	TAPA GN	

- Ausführung: einrastendem Deckel
- HACCP Markierungs-Clips verwendbar
- Clips im Lieferumfang nicht enthalten
- Design: snap-in lid
- HACCP marking clips can be used
- Clips not included in the package

#	GN	
530170	1/1	
530171	1/2	
530172	1/3	
530173	1/4	
530174	1/6	
530175	1/9	

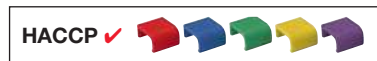

DE	HACCP MARKIERUNGS-CLIPS	
EN	HACCP MARKING CLIPS	
IT	CLIP DI MARCATURA HACCP	
ES	CLIPS MARCADORES HACCP	

Set á 12 Stk. je Farbe

Set of 12 pcs. per color

#		
530195	● rot / red	
530196	● grün / green	
530197	● blau / blue	
530198	● gelb / yellow	
530199	● lila / purple	



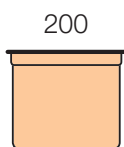
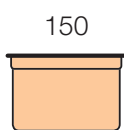
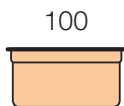
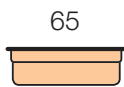
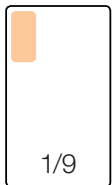
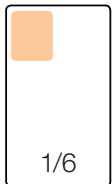
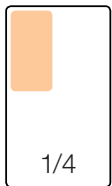
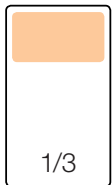
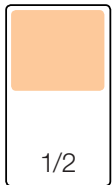
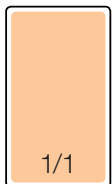



**DE** GN BEHÄLTER AUS POLYPROPYLEN  
**EN** GN CONTAINERS MADE OF POLYPROPYLENE  
**IT** CONTENITORI GN IN POLIPROPILENE  
**ES** CONTENEDORES GASTRONORM POLIPROPILENO



PP

#	GN	↑ mm	⬇ mm	
530000	1/1	65	9,0	
530001	1/1	100	13,3	
530002	1/1	150	20,0	
530003	1/1	200	26,4	
530010	1/2	65	4,0	
530011	1/2	100	6,1	
530012	1/2	150	9,0	
530013	1/2	200	11,9	
530020	1/3	65	2,5	
530021	1/3	100	3,8	
530022	1/3	150	5,5	
530023	1/3	200	7,1	
530030	1/4	65	1,7	
530031	1/4	100	2,6	
530032	1/4	150	3,8	
530033	1/4	200	4,8	
530040	1/6	65	1,0	
530041	1/6	100	1,6	
530042	1/6	150	2,3	
530043	1/6	200	2,8	
530050	1/9	65	0,6	
530051	1/9	100	0,9	





DE	GN EINSATZ / ABTROPFGITTER	 
EN	GN INSERT / DRAINER PLATE	
IT	GN FALSO FONDO FORATO	
ES	GN FONDO PERFORADO	

- Für Behälter aus PP und PC geeignet
- Suitable for PP and PC containers

#	GN	
530060	1/1	
530061	1/2	
530062	1/3	
530063	1/4	
530064	1/6	



DE	GN DECKEL	 
EN	GN LID	
IT	COPERCHIO GN	
ES	TAPA GN	

- Ausführung: einrastender Deckel
- HACCP Markierungs-Clips verwendbar
- Clips im Lieferumfang nicht enthalten
- Design: snap-in lid
- HACCP marking clips can be used
- Clips not included in the package

#	GN	
530005	1/1	
530015	1/2	
530025	1/3	
530035	1/4	
530045	1/6	
530055	1/9	



DE	GN DECKEL MIT SILIKONDICHTUNG, DICHTSCHLIESSEND	
EN	GN LID WITH SILICONE GASKET, TIGHTLY CLOSING	
IT	COPERCHIO GN CON GUARNIZIONE IN SILICONE, CHIUSURA ERMETICA	
ES	TAPA GN CON JUNTA DE SILICONA, CIERRE HERMÉTICO	

- Ausführung: luftdichte Silikondichtung
- Einfache Handhabung durch Entlüftungsventil
- Design: airtight silicone seal
- Easy handling due to air valve

#	GN	
530070	1/1	
530071	1/2	
530072	1/3	
530073	1/4	
530074	1/6	



DE	HACCP MARKIERUNGS-CLIPS	
EN	HACCP MARKING CLIPS	
IT	CLIP DI MARCATURA HACCP	
ES	CLIPS MARCADORES HACCP	

Set á 12 Stk. je Farbe

Set of 12 pcs. per color

#		
530195	● rot / red	
530196	● grün / green	
530197	● blau / blue	
530198	● gelb / yellow	
530199	● lila / purple	



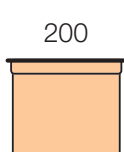
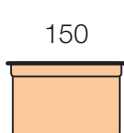
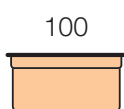
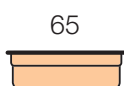
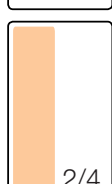
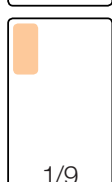
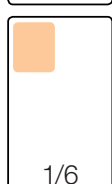
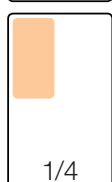
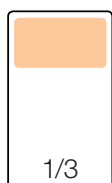
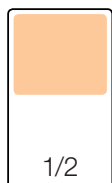
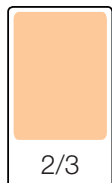
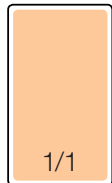
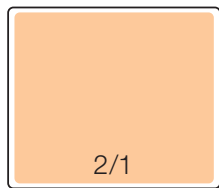

DE	GN BEHÄLTER AUS EDELSTAHL	
EN	GN CONTAINERS MADE OF STAINLESS STEEL	
IT	CONTENITORI GN IN ACCIAIO INOX	SST
ES	CONTENEDORES GASTRONORM ACERO INOXIDABLE	

#	GN	↑ mm	⊗	⊥ mm	
530270	2/1	20	4,5	0,8	
530271	2/1	40	12,0	0,8	
530272	2/1	65	19,0	0,8	
530200	1/1	20	1,9	0,8	
530201	1/1	40	5,4	0,8	
530202	1/1	65	8,7	0,8	
530203	1/1	100	13,0	0,8	
530204	1/1	150	20,0	0,8	
530205	1/1	200	26,0	0,8	
530210	2/3	20	1,3	0,8	
530211	2/3	40	3,4	0,8	
530212	2/3	65	5,5	1,0	
530213	2/3	100	8,4	0,8	
530214	2/3	150	12,0	0,8	
530215	2/3	200	16,0	1,0	
530220	1/2	20	0,8	0,8	
530221	1/2	40	2,4	0,8	
530222	1/2	65	3,8	0,8	
530223	1/2	100	5,9	0,8	
530224	1/2	150	8,7	0,8	
530225	1/2	200	11,0	1,0	
530230	1/3	20	0,6	0,8	
530231	1/3	40	1,5	0,8	
530232	1/3	65	2,5	0,8	
530233	1/3	100	3,8	0,8	
530234	1/3	150	5,5	0,8	
530235	1/3	200	7,0	0,9	
530240	1/4	20	0,4	0,8	
530241	1/4	40	1,2	0,8	
530242	1/4	65	1,7	0,8	
530243	1/4	100	2,7	0,8	
530244	1/4	150	3,8	0,8	
530245	1/4	200	4,8	1,0	
530250	1/6	65	1,0	0,8	
530251	1/6	100	1,6	0,8	
530252	1/6	150	2,2	0,8	
530253	1/6	200	2,8	1,0	
530260	1/9	65	0,6	0,8	
530261	1/9	100	0,9	0,8	
530282	2/4	65	4,3	0,8	
530283	2/4	100	6,5	0,8	
530284	2/4	150	10	0,8	

DE	GN BEHÄLTER AUS EDELSTAHL – GELOCHTE AUSFÜHRUNG	
EN	GN CONTAINERS MADE OF STAINLESS STEEL – PERFORATED	SST
IT	CONTENITORI GN IN ACCIAIO INOX – FORATI	
ES	CONTENEDORES GASTRONORM ACERO INOXIDABLE – PERFORADOS	

#	GN	↑ mm	↕ mm	↕ mm	
530300	1/1	65	8,7	0,8	
530301	1/1	100	13,0	0,8	
530302	1/1	150	20,0	0,8	
530310	2/3	65	5,5	1,0	
530311	2/3	100	8,4	0,8	
530312	2/3	150	12,0	0,8	
530320	1/2	65	3,8	0,8	
530321	1/2	100	5,9	0,8	
530322	1/2	150	8,7	0,8	



DE	GN DECKEL	
EN	GN LID	SST
IT	COPERCHIO GN	
ES	TAPA GN	

#	GN	↕ mm	
530206	1/1	0,7	
530216	2/3	0,7	
530226	1/2	0,7	
530236	1/3	0,7	
530246	1/4	0,7	
530256	1/6	0,7	
530266	1/9	0,7	
530286	2/4	0,7	



DE	GN DECKEL – MIT LÖFFELAUSSPARUNG	
EN	GN LID – WITH HOLE FOR LADLE	SST
IT	COPERCHIO GN – CON USCITA PER MESTOLO	
ES	TAPA GN – CON ABERTURA PARA CUCHARÓN	

#	GN	↕ mm	
530207	1/1	0,7	
530217	2/3	0,7	
530227	1/2	0,7	
530237	1/3	0,7	
530247	1/4	0,7	
530257	1/6	0,7	
530267	1/9	0,7	



14

DE	STEG FÜR GN BEHÄLTER	
EN	ADAPTOR BAR	SST
IT	SEPARATORE	
ES	BARRA ADAPTADORA	

#	GN	↕ mm	
530490	1/1	0,8	
530491	1/2	0,8	



DE	STABMIXER
EN	STICK BLENDER
IT	MIXER AD IMMERSIONE
ES	BATIDORA DE INMERSIÓN



Digital-anzeige  
 Digital Display

- Professionelle Qualität
  - Gehäuse aus stabilem Kunststoff
  - Rührstab und Messer aus Edelstahl
  - Leicht zu reinigen
  - Luftgekühlter Motor
  - Für die Zubereitung von Eis, Suppen, Mousses, Soßen, Füllungen, Mayonnaise, etc.
- Professional quality
  - Housing made of sturdy plastic
  - Stainless steel blender and blades
  - Easy to clean
  - Air-cooled motor
  - For the preparation of ice cream, soups, purées, sauces, fillings, mayonnaise, etc.



# 153600: nur Motorblock / only motor

# 153601: Stab / blender



# 153610



# 153620

#	153610	153620	153600
	mit Rührstab / with blender	mit Rührstab und Schneebesen / with blender and whisk	<u>nur</u> Motorblock / <u>only</u> motor
	250 W	250 W	400 W
	230 V 50–60 Hz	230 V 50–60 Hz	230 V 50–60 Hz
Geschwindigkeit regelbar Speed adjustable	nein / no	ja / yes	ja / yes
Umdrehungen / Revolutions min.	15.000	2.500 – 15.000	2.000 – 15.000
Ø mm	75	75	100
↗ mm 	285	285	350
↗ mm 	270	270	–
 kg	1,0	1,0	2,1



Zubehör für MIX 400 V # 153600	153601	153602	153603	153604
	Rührstab / blender	Rührstab / blender	Rührstab / blender	Schneebesen / whisk
Ø mm	85	85	85	120
↗ mm	340	440	540	330
 kg	0,9	1,0	1,2	0,8



DE	LIKÖR- UND FONDANTTRICHTER
EN	CONFECTIONERY FUNNEL
IT	IMBUTO COLATORE
ES	EMBUDO COLADOR

- Material: Edelstahl
- Ergonomischer Griff aus Kunststoff
  - Mit 3 Dosiertüllen (3, 4 und 5 mm)
  - Inklusive Ständer und Auffangschale

- Made of stainless steel,
- Ergonomic handle made of plastic
  - With three different nozzles (3, 4 und 5 mm)
  - Including wire rack and dripping dish

#	Ø mm	↑ mm	↓ I	
199940	195	210	1,8	



- Material: Edelstahl
- Mit 3 Dosiertüllen (2, 4 und 6 mm)
  - Inklusive Ständer

- Made of stainless steel,
- With three different nozzles (2, 4 and 6 mm)
  - Including wire rack

#	Ø mm	↑ mm	↓ I	
199999	190	230	1,5	



DE	TRÜFFELFÜLLER
EN	TRUFFLE FILLER
IT	IMBUTO COLATORE
ES	EMBUDO COLADOR

- Material: Edelstahl, lebensmittelechter Kunststoff
- Universell zum Füllen mit Quark, Pudding, Ganache, Likör, Marmelade, Creme
  - Stufenlose und genaue Mengeneinstellung 1 – 17 g
  - Gewicht: 0,7 kg

- Made of stainless steel, food-safe plastic
- Universal for filling with curd cheese, pudding, ganache, liqueur, jam, cream
  - Stepless and precise quantity adjustment 1 – 17 g
  - Weight: 0.7 kg

#	Ø mm	↑ mm	↓ I	
199950	300	200	1,0	



DE	BACKTRENNSPRAY
EN	RELEASE SPRAY
IT	SPRAY STACCANTE ANTIADERENTE
ES	DESMOLDEANTE EN SPRAY

Das perfekte Trennspray für Bäckereien, Konditoreien, Küchen und Gastronomie. Speziell für WALTER-Backformen geeignet. Kein Anbacken oder Ankleben der Backwaren; keine Rückstände in der Form oder auf dem Blech. Reines Lebensmittel, 100 % geschmacksneutral.  
 Zutaten: Pflanzliche Öle  
 Verdickungsmittel: Carnaubawachs  
 Emulgator: Sonnenblumenlecithine  
 Treibgas: Butan / Isobutan / Propan  
**Nur zur gewerblichen Verarbeitung. Nicht für Luftfracht zugelassen.**

The ideal release spray for bakeries, confectioneries, hotel and restaurant kitchens. Especially suitable for WALTER baking moulds. No caking or sticking of the baked goods; no residues in the mould or on the tray. 100 % safe for consumption and tasteless.  
 Ingredients: vegetable oils  
 Thickener: carnauba wax  
 Emulsifier: sunflower lecithin  
 Propellant: butane / isobutane / propane  
**Only for professional use. Not permitted for transport via airfreight.**



#	ml		
266960	500	Butan / Isobutan / Propan	

DE	FONDANTTRICHTER / SAUCENPORTIONIERER – ELEKTRISCH BEHEIZBAR
EN	SAUCE-WARMER
IT	SCALDA SALSE
ES	CALENTADOR DE SALSAS



Material: Edelstahl

- Zum Warmhalten und Dosieren von flüssigen Speisen wie Soßen, Cremes, Schokolade, Füllungen, etc.
- Temperatur von + 40° C bis + 70° C einstellbar
- Inklusive herausnehmbarer Auffangschale
- Kein Wasserbad – Temperatureaustausch erfolgt über Direktkontakt / Luft
- Trichter: Volumen 2 Liter
- Inklusive Deckel und 3 Dosiertüllen

Made of stainless steel

- For keeping warm and dosing liquid foods such as sauces, creams, chocolate, fillings, etc.
- Temperature adjustable from + 40° C to + 70° C
- Including removable drip tray
- No bain marie – temperature exchange via direct contact / air
- Funnel: Volume 2 litres
- Including lid and 3 dosing nozzles



#	150590
→ mm	350
↗ mm	285
↑ mm	370
	300 W
	220 – 240 V / 50/60 Hz
	4,8 kg



DE	PLANETEN-RÜHRMASCHINE „CHEF 9000“
EN	PLANETARY MIXER „CHEF 9000“
IT	IMPASTATRICE PLANETARIA „CHEF 9000“
ES	BATIDORA PLANETARIA „CHEF 9000“

- Volumen: 7,0 Liter
- Leistung: 325 W
- Spannung: 230 V / 50 – 60 Hz
- Umdrehungen pro Minute: 40 Minimum / 250 Maximum
- Rührgeschwindigkeit stufenlos regelbar
- Inklusive Schneebesen, Knethaken und Flachrührer
- Gehäuse aus lackiertem Stahl
- Rührschüssel aus rostfreiem Edelstahl
- Schüssel Ø: 250 mm / Höhe: 220 mm
- Sicherheitsschutzgitter mit Mikroschalter
- Speziell für leichte Massen wie Waffelteig, Sahne etc.

- Volume: 7,0 liters
- Power: 325 W
- Voltage: 230 V / 50 – 60 Hz
- Revolutions per minute: 40 minimum / 250 maximum
- Speed adjustable
- Including whisk, hook and spatula
- Housing made of varnished steel
- Mixing bowl made of stainless steel
- Bowl Ø: 250 mm / Height: 220 mm
- Safety guard with micro switch
- Especially for light masses like waffle dough, cream etc.



#	↔ mm		kg
159900	420 x 250 x 420 mm	17,5	
159902	Ersatzschüssel <b>mit</b> Griff / Spare bowl <b>with</b> handle		





DE	LEBENSMITTEL-SPRÜHPISTOLE "ALEXO 200"	
EN	SPRAY GUN "ALEXO 200"	
IT	PISTOLA POLVERIZZATRICE ELETTRICA "ALEXO 200"	
ES	PISTOLA PULVERIZADORA ELÉCTRICA "ALEXO 200"	

- Verarbeitbare Materialien: Butter, Öle, Fette, Wachse, Gelee, Konfitüre, Trennmittel und Emulsionen
  - **100% lebensmittelecht**
  - Für warme Flüssigkeiten bis 65 °C
  - Fördermenge: 250 g/min
  - Inhalt: 700 ml
  - Leistung: 60 Watt
  - Staudruck: 0 – 160 bar
  - Gewicht: 1,3 kg
- Wird mit Rundstrahldüse R6 geliefert
- Usability: butter, oil, fat, wax, jelly, jam, releasing agent and emulsions
  - **100% food safe**
  - Usable for warm liquids max. 65 °C
  - Dispense quantity: 250 g/min
  - Volume: 700 ml
  - Power: 60 W
  - Pressure: 0 – 160 bar
  - Weight: 1.3 kg
- Supplied with circular jet nozzle R6

#		
153900	Sprühpistole/spray gun	

DE	ZUBEHÖR FÜR SPRÜHPISTOLE "ALEXO 200 + 400"
EN	ACCESSORIES FOR SPRAY GUN "ALEXO 200 + 400"
IT	PEZZI DI RICAMBIO PER PISTOLA POLVERIZZATRICE ELETTRICA "ALEXO 200 + 400"
ES	RECAMBIOS PARA PISTOLA PULVERIZADORA ELÉCTRICA "ALEXO 200 +400"



#		
153901	Flüssigkeitsaustritt 0,4 mm / feinsten Wasserstaub Rundstrahldüse R4 / circular jet nozzle R4	



153902	Flüssigkeitsaustritt 0,6 mm Rundstrahldüse R6 / circular jet nozzle R6	
--------	---	--



153903	Flüssigkeitsaustritt 0,8 mm / für dickflüssigere Flüssigkeiten Rundstrahldüse R8 / circular jet nozzle R8	
--------	--	--



153904	zum Reinigen von Backöfen / Combi-Dämpfer Flachstrahldüse F7S / flat jet nozzle F7S	
--------	--	--



153905	Reinigungsdüse / cleaning nozzle	
--------	----------------------------------	--



153906	Düsenverlängerung / nozzle extension	
--------	--------------------------------------	--



153908	Behälter mit Deckel / container with lid	
153935	Ersatzdeckel / replacement lid	
153909	Drall mit Ventilsfeder / spin with spring	

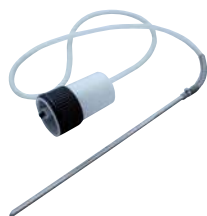

DE	ANSAUGVORRICHTUNG FÜR "ALEXO 200 + 400"
EN	SUCTION PIPE FOR "ALEXO 200 + 400"
IT	DISPOSITIVO DI ASPIRAZIONE PER "ALEXO 200 + 400"
ES	DISPOSITIVO DE ASPIRACIÓN PARA "ALEXO 200 + 400"

#		
153961	150 cm Schlauchlänge, 40 cm Rohrlänge (Edelstahl) / hose 150 cm length, stainless steel pipe 40 cm	



DE	LEBENSMITTEL-SPRÜHPISTOLE "ALEXO 400"	
EN	SPRAY GUN "ALEXO 400"	
IT	PISTOLA POLVERIZZATRICE ELETTRICA "ALEXO 400"	
ES	PISTOLA PULVERIZADORA ELÉCTRICA "ALEXO 400"	

- Verarbeitbare Materialien: Butter, Öle, Fette, Wachse, Gelee, Konfitüre, Trennmittel und Emulsionen
  - **100% lebensmittelecht**
  - Für warme Flüssigkeiten bis 65 °C
  - Fördermenge: 350 g/min
  - Inhalt: 700 ml
  - Leistung: 90 Watt
  - Staudruck: 0 – 180 bar
  - Gewicht: 1,7 kg
- Usability: butter, oil, fat, wax, jelly, jam, releasing agent and emulsions
- **100% food safe**
  - Usable for warm liquids max. 65 °C
  - Dispense quantity: 350 g/min
  - Volume: 700 ml
  - Power: 90 W
  - Pressure: 0 – 180 bar
  - Weight: 1.7 kg
- Wird mit Rundstrahldüse R8 geliefert
- Supplied with circular jet nozzle R8



#	Ø mm	
153960	700 / 1400	

DE	DRUCKPUMPENZERSTÄUBER	
EN	COMPRESSED AIR SPRAYER	
IT	POLVERIZZATORE	
ES	PULVERIZADOR MANUAL POR BOMBEO	

- Flexibler Druckpumpenzerstäuber für einfaches Versprühen von Flüssigkeit durch Luftdruck.
- Pressure sprayer for easy and flexible spraying of all liquids by air-pressure.
- Handlich und vielseitig einsetzbar
  - Große Flächen können problemlos gleichmäßig eingesprüht werden
  - Druckaufbau durch Pumpstange
  - **100% Lebensmittelecht**
- Suitable for nearly all liquids
  - Large surfaces can be sprayed easily and even
  - **100% food safe**

#	↔ mm	 l	
153950	303 x 233 x 135	1,8	4 bar



- Flexibler Druckpumpenzerstäuber für einfaches Versprühen von Flüssigkeit durch Luftdruck.
- Pressure sprayer for easy and flexible spraying of all liquids by air-pressure.
- Handlich und vielseitig einsetzbar
  - Große Flächen können problemlos gleichmäßig eingesprüht werden
  - Druckaufbau durch Pumpstange
  - Druckflussmenge/Förderleistung: 300 ml/min.
  - Integrierte Skala
  - Für Flüssigkeiten bis +30 °C
  - **100% Lebensmittelecht**
- Suitable for nearly all liquids
  - Large surfaces can be sprayed easily and evenly
  - Pressure flow rate / delivery rate: 300 ml/min.
  - Integrated scale
  - For liquids up to +30°C
  - **100% food safe**

#	↔ mm	 l	
153952	313 x 206 x 119	1,2	3 bar





DE BACKBLECHE / KONVEKTOMATENBLECHE  
 EN BAKING TRAYS  
 IT TEGLIE  
 ES BANDEJAS PARA HORNO



Material: Stahlblech, Granit-Emaille

Made of steel, enamel granite

- Beidseitig beschichtet
- Materialstärke: 1,0 mm

- Coated on both sides
- Thickness: 1.0 mm

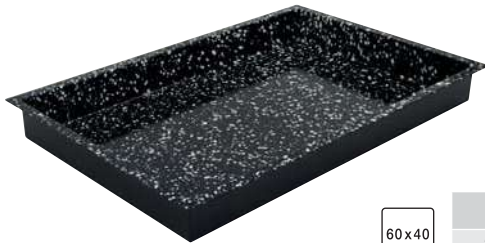

600 x 400 – Ausführung: 4 Seiten 90°

600 x 400 – Type: 4 sides 90°

60x40

#	↗ mm	→ mm	↑ mm
382562	600	400	60

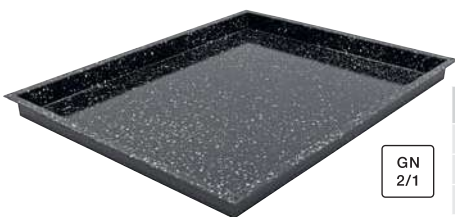

GN  
2/1

GN 2/1 – Ausführung: 4 Seiten 90°

GN 2/1 – Type: 4 sides 90°

#	↗ mm	→ mm	↑ mm
382500	530	650	20
382501	530	650	40
382502	530	650	60

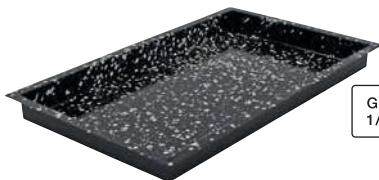

GN  
1/1

GN 1/1 – Ausführung: 4 Seiten 90°

GN 1/1 – Type: 4 sides 90°

#	↗ mm	→ mm	↑ mm
382510	530	325	20
382511	530	325	40
382512	530	325	60

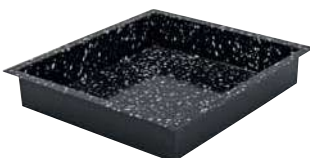

GN  
2/3

GN 2/3 – Ausführung: 4 Seiten 90°

GN 2/3 – Type: 4 sides 90°

#	↗ mm	→ mm	↑ mm
382520	354	325	20
382521	354	325	40
382522	354	325	60

DE	GN-BACKBLECHE / KONVEKTOMATENBLECHE
EN	GN-BAKING TRAYS
IT	TEGLIE GN
ES	BANDEJAS PARA HORNO GN



Material: Stahlblech, Emaille, schwarz  
 • Beidseitig beschichtet

Made of steel, enamel, black  
 • Coated on both sides

#	↗ mm	→ mm	↑ mm	⏊ mm	⏊ l
382530	530	325	20	0,8	2,5
382531	530	325	40	0,8	5,3
382532	530	325	65	0,8	8,8
382533	325	265	40	0,8	2,5
382534	325	265	65	0,8	4,0
382535	325	176	40	0,8	1,8
382536	325	176	65	0,8	2,4



DE	BACKTRENNPAPIERE
EN	BAKING RELEASE PAPERS
IT	CARTA DA FORNO
ES	PAPEL DE HORNO SILICONADO

Pergamentersatz, gebleicht  
 • Beidseitig silikonisiert  
 • Mehrmals verwendbar

Greaseproof, bleached  
 • Two sides siliconized  
 • Multiple bakes

“SUPER EXTRA”

“SUPER EXTRA”

#	↔ mm x m	⚖ g/m <sup>2</sup>	🛒
103032	320 x 530 <b>GN 1/1</b>	41	500
103078	520 x 640 <b>GN 2/1</b>	41	500



**i** Passende GN-Backbleche auf Seite 41. / Suitable GN-baking trays on page 41.

DE	GRILLROSTE
EN	GRIDS
IT	GRIGLIE
ES	REJILLAS

SST

60x40

#		↗ mm	→ mm	≡	Ø mm	Drähte Ø mm / wire Ø mm
156110		600	400	2	6	24 / 3
156111	<b>GN 1/1</b>	530	325	1	7	20 / 3
156112	<b>GN 2/3</b>	354	325	1	5	15 / 2
156113	<b>GN 2/1</b>	650	530	3	6	32 / 2

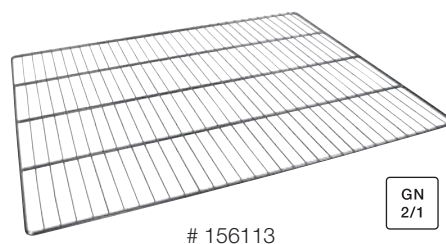
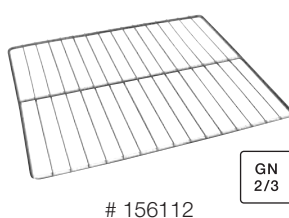
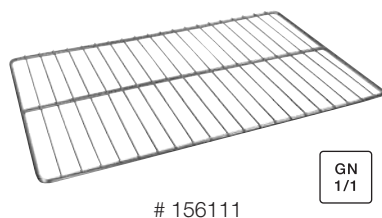
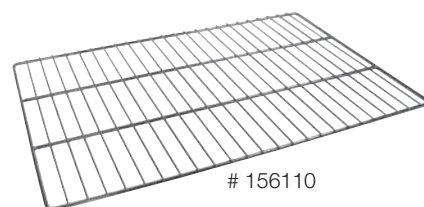



© stock.adobe.com

<p><b>GEWERBEQUALITÄT</b></p> <ul style="list-style-type: none"> <li>• Edelstahlgehäuse</li> <li>• Hochwertige Glaskeramik</li> </ul> <p><b>COMMERCIAL QUALITY</b></p> <ul style="list-style-type: none"> <li>• Stainless steel case</li> <li>• High quality glass ceramic</li> </ul>	<p><b>GLASKERAMIK</b></p> <ul style="list-style-type: none"> <li>• Kein Einbrennen</li> <li>• Einfache Reinigung mit einem feuchten Stofftuch</li> </ul> <p><b>GLASS CERAMIC</b></p> <ul style="list-style-type: none"> <li>• No burning in</li> <li>• Easy cleaning with a damp cloth</li> </ul>	<p><b>FUNKTIONEN</b></p> <ul style="list-style-type: none"> <li>• Timerfunktion bis 99 Minuten</li> </ul> <p><b>FEATURES</b></p> <ul style="list-style-type: none"> <li>• Timer function up to 99 minutes</li> </ul>	<p><b>SICHERHEIT</b></p> <ul style="list-style-type: none"> <li>• Alle Geräte haben eine automatische Pfannen- und Topferkennung</li> <li>• Nur ferromagnetische Pfannen und Töpfe können erhitzt werden</li> </ul> <p><b>SAFETY</b></p> <ul style="list-style-type: none"> <li>• All devices have an automatic pan and pot detection</li> <li>• Only ferromagnetic pans and pots can be heated</li> </ul>
<p><b>EINFACHE BEDIENUNG</b></p> <ul style="list-style-type: none"> <li>• Einfache und schnelle Einstellung auf der Glasoberfläche oder dem Display</li> </ul> <p><b>EASY HANDLING</b></p> <ul style="list-style-type: none"> <li>• Easy and quick setting on the glass surface or the display</li> </ul>	<p><b>ZEITSPAREND</b></p> <ul style="list-style-type: none"> <li>• Deutlich schneller als Elektroherde</li> </ul> <p><b>TIME-SAVING</b></p> <ul style="list-style-type: none"> <li>• Much faster than electric stoves</li> </ul>	<p><b>ENERGIESPAREND</b></p> <ul style="list-style-type: none"> <li>• Schnelles und direktes Erhitzen</li> <li>• Umweltschonend</li> </ul> <p><b>ENERGY-SAVING</b></p> <ul style="list-style-type: none"> <li>• Fast and direct heating</li> <li>• Environmentally friendly</li> </ul>	<p><b>ÜBERALL EINSETZBAR</b></p> <ul style="list-style-type: none"> <li>• Alle Induktionsgeräte mit 230 Volt-Schuko-Stecker</li> <li>• Kabellänge: 1,4 m</li> </ul> <p><b>USEABLE EVERYWHERE</b></p> <ul style="list-style-type: none"> <li>• All induction devices with 230 volt safety plug</li> <li>• Cable length: 1.4 m</li> </ul>

DE	INDUKTIONSKOCHFELD
EN	INDUCTION HOB
IT	PIASTRA AD INDUZIONE
ES	PLACA DE INDUCCIÓN



- Edelstahlgehäuse
- Starke Glaskeramik-Oberfläche
- Touchbedienfeld mit Digitalanzeige
- Heizstufen: 1–10 (500–3500 W)
- Spannung: 230 V, 50/60 Hz
- Temperatur: 60–240 °C
- Timerfunktion: bis 180 min.

- Stainless steel case
- Strong glass ceramic surface
- Touch control panel with digital display
- Heating levels: 1–10 (500–3500 W)
- Voltage: 230 V, 50/60 Hz
- Temperature: 60–240 °C
- Timer function: up to 180 min.

#	↔ mm	⏏	⚖ kg
147200	425 x 330 x 105	3500	6,0



DE	BRATPFANNEN
EN	FRYING PANS
IT	PADELLE
ES	SARTENES



**Edelstahlpfanne**

- Kaltgriff aus Edelstahl
- Hochwertige Antihafbeschichtung

**Stainless steel pan**

- Cold handle made of stainless steel
- High quality non-stick coating

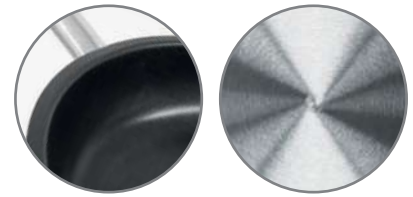

**• Reinigung in der Spülmaschine kann die Lebensdauer verringern!**

**• Cleaning in the dishwasher may reduce the life of the product!**

#	Ø mm	↑ mm	↓ mm	↑ mm
<input checked="" type="checkbox"/> 531050	240	58	2,0	0,8
<input checked="" type="checkbox"/> 531051	280	62	3,6	0,8
<input checked="" type="checkbox"/> 531052	320	66	4,8	0,8



**Alupfanne** für optimale Wärmeleitung

- Kaltgriff aus Edelstahl
- Hochwertige Antihafbeschichtung

**Aluminium pan** for optimal heat conduction

- Cold handle made of stainless steel
- High quality non-stick coating



**• Reinigung in der Spülmaschine kann die Lebensdauer verringern!**

**• Cleaning in the dishwasher may reduce the life of the product!**

#	Ø mm	↑ mm	↓ mm	↑ mm
<input checked="" type="checkbox"/> 531070	240	35	1,40	3,5
<input checked="" type="checkbox"/> 531071	280	45	2,05	3,5
<input checked="" type="checkbox"/> 531072	320	47	2,85	3,5

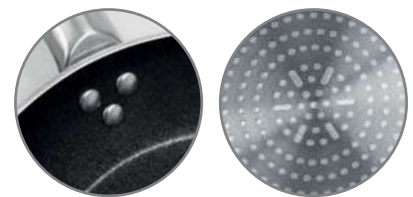

**Alugusspfanne** für fettfreies Kochen und Braten

- Kaltgriff aus Edelstahl
- Hochwertige Antihafbeschichtung
- Schnelle, gleichmäßige Hitzeverteilung und lange Wärmespeicherung

**Aluminium cast pan** for fat-free cooking and frying

- Cold handle made of stainless steel
- High quality non-stick coating
- Fast, even heat distribution and long heat retention



**• Reinigung in der Spülmaschine kann die Lebensdauer verringern!**

**• Cleaning in the dishwasher may reduce the life of the product!**

#	Ø mm	↑ mm	↓ mm	↑ mm
<input checked="" type="checkbox"/> 531076	240	50	2,5	2,0
<input checked="" type="checkbox"/> 531077	280	50	3,5	2,0
<input checked="" type="checkbox"/> 531078	300	50	4,1	2,0

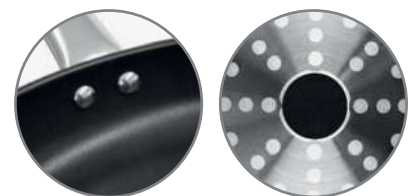



**DE** KOCHTÖPFE  
**EN** STOCK POTS  
**IT** PENTOLE  
**ES** OLLAS RECTAS

Absolute Profi-Qualität, Edelstahl 18/10  
 • Satinierte Oberfläche  
 • Mehrfach punktgeschweißte Kalt-Griffe  
 • 8 mm Sandwichboden (Edelstahl, Aluminium, magnetischer Stahl)  
 • Induktionsgeeignet, Schüttrand

High professional quality, 18/10 stainless steel  
 • Satin surface  
 • Multiple spot-welded cold handles  
 • 8 mm sandwich bottom (stainless steel, aluminium, magnetic steel)  
 • Suitable for induction, pouring rim



#	Ø mm	↑ mm	⊕ l	⊥ mm
531000	160	160	3,1	0,8
531001	200	200	6,1	0,8
531002	240	240	11,0	0,8
531003	280	280	17,0	0,8
531004	320	320	25,0	1,0
531005	360	360	33,0	1,0
531006	400	400	49,0	1,0



**DE** FLEISCHTÖPFE  
**EN** STEWPOTS  
**IT** PENTOLE PER CARNE  
**ES** CACEROLAS ALTAS



#	Ø mm	↑ mm	⊕ l	⊥ mm
531010	160	110	2,1	0,8
531011	200	130	4,0	0,8
531012	240	150	6,6	0,8
531013	280	170	10,0	0,8
531014	320	200	16,0	0,8
531015	360	220	21,0	1,0

DE	BRATENTÖPFE
EN	STEWPOTS
IT	PENTOLE PER ARROSTO
ES	CACEROLAS BAJAS



#	Ø mm	↑ mm	⚓ l	↓ mm
531020	160	80	1,6	0,8
531021	200	90	2,7	0,8
531022	240	100	4,4	0,8
531023	280	120	7,2	0,8
531024	320	150	12,0	0,8



DE	STIELKASSEROLLEN
EN	SAUCEPANS
IT	CASSERUOLE CON MANICO
ES	CACEROLAS BAJAS



#	Ø mm	↑ mm	⚓ l	↓ mm
531030	160	70	1,4	0,8
531031	180	80	2,0	0,8
531032	200	90	2,8	0,8



DE	DECKEL
EN	LIDS
IT	COPERCHI
ES	TAPAS



#	Ø mm	↓ mm
531060	160	0,8
531061	200	0,8
531062	240	0,8
531063	280	0,8
531064	320	0,8
531065	360	0,8
531066	400	0,8



DE	SAUTEUSEN
EN	SAUTEUSES
IT	SAUTEUSE
ES	SAUTEUSE



#	Ø mm	↑ mm	⚓ l	↓ mm
<input checked="" type="checkbox"/> 531040	160	60	1,0	0,8
<input checked="" type="checkbox"/> 531041	180	60	1,2	0,8
<input checked="" type="checkbox"/> 531042	200	65	1,6	0,8



14

Sandwichboden /  
Sandwich bottom

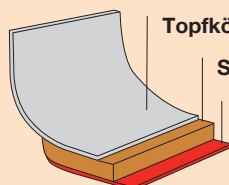

Topfkörper aus Edelstahl / Stainless steel pot body

Starker Kern aus Aluminium / Strong aluminium core

Bodenkapsel aus Edelstahl / Stainless steel bottom capsule



DE	VORLEGEBESTECK HITZEBESTÄNDIG
EN	CUTLERY, HEAT-RESISTANT
IT	UTENSILI RESISTENTI AL CALORE
ES	CUBERTERÍA REFRACTARIA

Material: PPA, schwarz

Made of PPA, black

• Hitzebeständig bis + 270 °C (\*+ 220 °C)

• Heat resistant up to + 270 °C (\*+ 220 °C)

#		↗ mm	↔ mm / Ø
<input checked="" type="checkbox"/> 172460	Bratgutwender / slotted turner	310	85
<input checked="" type="checkbox"/> 172461	Suppenkelle / soup ladle	300	90 x 35
<input checked="" type="checkbox"/> 172462	Spaghettilöffel / spaghetti spoon	300	72
<input checked="" type="checkbox"/> 172463	Schaumlöffel / skimmer	325	108
<input checked="" type="checkbox"/> 172464	Servierlöffel / serving spoon	300	65
<input checked="" type="checkbox"/> 172465	Kochlöffel / cooking spoon	300	62
<input checked="" type="checkbox"/> 172370	Pinzette* / kitchen pincers*	305	18

\* hitzebeständig bis + 220 °C / heat resistant up to + 220 °C



DE	SPACHTELN
EN	SPATULAS
IT	SPATOLE TRIANGOLARI INOX CON MANICO NERO
ES	ESPÁTULAS TRIANGULARES, MANGO NEGRO

Material: Edelstahl,  
Kunststoffgriff schwarz (PP)

Made of stainless steel,  
black plastic handle (PP)

#	→ mm
<input checked="" type="checkbox"/> 200500	40
<input checked="" type="checkbox"/> 200501	60
<input checked="" type="checkbox"/> 200502	80
<input checked="" type="checkbox"/> 200503	100
<input checked="" type="checkbox"/> 200504	120





DE	VORLEGEBESTECK
EN	CUTLERY
IT	UTENSILI
ES	CUBERTERÍA

Material: Edelstahl

- Poliert
- Fugenlos

Made of stainless steel

- Polished
- Seamless

#		↗ mm	↔ mm / Ø	🍷 ml	
<input checked="" type="checkbox"/> 175000	Saucenlöffel / Spoon	315	60 x 80		
<input checked="" type="checkbox"/> 175001	Schaumlöffel / Skimmer	315	85		
<input checked="" type="checkbox"/> 175002	Pfannenwender / Spatula	375	72 x 90		
<input checked="" type="checkbox"/> 175003	Pfannenwender, geschlitzt / Spatula slotted	375	72 x 90		
<input checked="" type="checkbox"/> 175004	Schöpfkelle / Ladle	340	85	30	
<input checked="" type="checkbox"/> 175005	Saucenlöffel / Sauce ladle	270	60	100	
<input checked="" type="checkbox"/> 175006	Servierlöffel / Spoon	340	60 x 90		
<input checked="" type="checkbox"/> 175007	Servierlöffel gelocht / Spoon perforated	340	60 x 90		





DE	SCHÖPFKELLEN
EN	LADLE
IT	MESTOLO
ES	CACILO

Material: Edelstahl  
 • Fugenlos  
 • Materialstärke: 3 mm

Made of stainless steel  
 • Seamless  
 • Thickness: 3 mm

#	↗ mm	Ø mm	⊞ l
<input checked="" type="checkbox"/> 175030	300	65	0,07
<input checked="" type="checkbox"/> 175032	320	80	0,125
<input checked="" type="checkbox"/> 175033	330	90	0,2
<input checked="" type="checkbox"/> 175037	370	100	0,25
<input checked="" type="checkbox"/> 175040	400	110	0,33
<input checked="" type="checkbox"/> 175043	430	120	0,5
<input checked="" type="checkbox"/> 175044	440	140	0,75
<input checked="" type="checkbox"/> 175047	470	160	1,0



DE	SCHAUMLÖFFEL
EN	SKIMMER
IT	SCHIUMAROLA
ES	ESPUMADERA

Material: Edelstahl, 3 mm  
 • Fugenlos  
 • Gelocht  
 • Breiter und flacher Boden  
 • Materialstärke: 3 mm

Made of stainless steel, 3 mm  
 • Seamless  
 • Perforated  
 • Wide and flat bottom  
 • Thickness: 3 mm

#	↗ mm	Ø mm
<input checked="" type="checkbox"/> 176080	290	80
<input checked="" type="checkbox"/> 176100	320	100
<input checked="" type="checkbox"/> 176120	350	120
<input checked="" type="checkbox"/> 176140	380	140
<input checked="" type="checkbox"/> 176160	410	160
<input checked="" type="checkbox"/> 176180	430	180



DE	FRITTIERSCHAUFEL
EN	WIRE SKIMMER
IT	SCHIUMAROLA A FILO
ES	ESPUMADERAS A MALLA

Material: Edelstahl  
 • Verstärkter Drahtgriff

Made of stainless steel  
 • Reinforced wire handle

#	↗ mm	Ø mm
<input checked="" type="checkbox"/> 178000	480	160
<input checked="" type="checkbox"/> 178001	560	180
<input checked="" type="checkbox"/> 178002	560	200
<input checked="" type="checkbox"/> 178003	640	220
<input checked="" type="checkbox"/> 178004	640	240
<input checked="" type="checkbox"/> 178005	650	260

DE	SERVIERLÖFFEL
EN	SERVING SPOON
IT	CUCCHIAIONI
ES	CUCHARÓN

- Material: Edelstahl
- Fugenlos
  - Materialstärke: 3 mm

- Made of stainless steel
- Seamless
  - Thickness: 3 mm

#	↗ mm	↔ mm
<input checked="" type="checkbox"/> 177040	330	
<input checked="" type="checkbox"/> 177041	450	
<input checked="" type="checkbox"/> 177042	480	

<input checked="" type="checkbox"/> 177050	460 / 380	95 x 70
--	-----------	---------



DE	SERVIERLÖFFEL – GELOCHT
EN	SERVING SPOON – PERFORATED
IT	CUCCHIAIONI
ES	CUCHARÓN

- Material: Edelstahl
- Fugenlos
  - Gelocht
  - Materialstärke: 3 mm

- Made of stainless steel
- Seamless
  - Perforated
  - Thickness: 3 mm

#	↗ mm
<input checked="" type="checkbox"/> 177030	330
<input checked="" type="checkbox"/> 177031	450
<input checked="" type="checkbox"/> 177032	480



DE	PFANNENWENDER
EN	SPATULA
IT	PALETTA
ES	ESPÁTULA

- Material: Edelstahl
- Fugenlos
  - Materialstärke: 3 mm

- Made of stainless steel
- Seamless
  - Thickness: 3 mm

#		↗ mm
<input checked="" type="checkbox"/> 177010	geschlossen / closed	380
<input checked="" type="checkbox"/> 177011	geschlitzt / slotted	380





DE	SAUCENLÖFFEL
EN	SPOON, CROSSWISE
IT	CUCCHIAIONE OBLIQUO
ES	CUCHARÓN OBLIQUO

Material: Edelstahl  
 • Fugenlos  
 • Materialstärke: 3 mm

Made of stainless steel  
 • Seamless  
 • Thickness: 3 mm

#		↗ mm	
<input checked="" type="checkbox"/>	177020	330	
<input checked="" type="checkbox"/>	177021	450	
<input checked="" type="checkbox"/>	177022	480	



DE	SPAGHETTLÖFFEL
EN	SPAGHETTI SPOON
IT	CUCCHIAIO PER SPAGHETTI
ES	TENEDOR ESPAGUETTIS

Material: Edelstahl  
 • Fugenlos  
 • Materialstärke: 3 mm

Made of stainless steel  
 • Seamless  
 • Thickness: 3 mm

#		↗ mm	Ø mm
<input checked="" type="checkbox"/>	177060	395 / 300	95 x 85



DE	FLEISCHGABEL
EN	MEAT FORK
IT	FORCHETTONE
ES	TENEDOR

Material: Edelstahl  
 • Fugenlos  
 • Materialstärke: 3 mm

Made of stainless steel  
 • Seamless  
 • Thickness: 3 mm

#	Zacken / Prongs	↗ mm	↔ mm	
<input checked="" type="checkbox"/>	177002	2	560 / 430	125 x 30
<input checked="" type="checkbox"/>	177003	3	560 / 430	125 x 40



DE	PASSIERSIEBE
EN	GOURMET SIEVES
IT	COLINI PASSABRODO
ES	COLADORES DE CALDO

- Material: Edelstahl
- Mit Griff und Auflagehaken
  - **Extra breiter Rand**

- Made of stainless steel
- With handle and hook
  - **Extra-wide rim**



#	Ø mm	☒ mm	
<input checked="" type="checkbox"/> 199328	180	0,84	

- Material: Edelstahl
- Mit Griff und Auflagehaken

- Made of stainless steel
- With handle and hooks

#	Ø mm	☒ mm	
<input checked="" type="checkbox"/> 199329	220	1,5	
<input checked="" type="checkbox"/> 199330	260	1,5	
<input checked="" type="checkbox"/> 199331	300	1,5	



- Material: Edelstahl
- Mit Griff und Auflagehaken

- Made of stainless steel
- With handle and hooks

#	Ø mm	☒ mm	
<input checked="" type="checkbox"/> 199370	160	1,5	
<input checked="" type="checkbox"/> 199371	180	1,5	
<input checked="" type="checkbox"/> 199372	200	1,5	
<input checked="" type="checkbox"/> 199373	220	1,5	
<input checked="" type="checkbox"/> 199374	240	1,5	
<input checked="" type="checkbox"/> 199375	260	1,5	



DE	GROSSKÜCHENSIEBE
EN	BOWL STRAINERS
IT	COLAPASTA RINFORZATI
ES	COLADORES REFORZADOS

- Material: Edelstahl
- Mit Schutzbügel

- Made of stainless steel
- With guard



#		Ø mm	☒ mm	
<input checked="" type="checkbox"/> 198840		260	1,5	
198841	Ersatzsieb / Spare strainer	260	1,5	





DE	KÜCHENSIEBE / PASSIERSIEBE
EN	SAUCE STRAINERS
IT	COLATUTTO
ES	COLADORES

Material: Edelstahl

Made of stainless steel

#	Ø mm	↑ mm	⊞ mm	
<input checked="" type="checkbox"/> 198870	80	30	1,0	
<input checked="" type="checkbox"/> 198871	100	35	1,0	
<input checked="" type="checkbox"/> 198872	120	50	1,5	
<input checked="" type="checkbox"/> 198873	150	50	1,5	
<input checked="" type="checkbox"/> 198874	180	65	1,5	
<input checked="" type="checkbox"/> 198875	200	70	1,5	



DE	GOURMET-PASSIERSIEBE
EN	GOURMET BOUILLON-SIEVES
IT	COLINI PASSABRODO
ES	COLADORES DE CALDO

Material: feinmaschiges Nylonnetz

Made of fine woven nylon cloth

- Zum Abseihen feiner Saucen, Dämpfen, Einmachen etc.
- Spülmaschinengeeignet
- Hitzebeständig bis +150 °C

- Kitchen net for straining, steaming, jam making etc.
- Dishwasher proof
- Heat-resistant up to +150 °C

#	Ø mm	
<input checked="" type="checkbox"/> 199095	200	
<input checked="" type="checkbox"/> 199096	240	
<input checked="" type="checkbox"/> 199097	280	
<input checked="" type="checkbox"/> 199098	350	



DE	SPITZSIEB
EN	CHINESE COLANDER
IT	CORNETTI CINESI
ES	COLADORES CHIONOS

Material: Edelstahl

Made of Stainless steel

- Mit Randhalterung
- 2 mm Lochung

- With rim holder
- 2 mm perforation

#	Ø mm	↔ mm	
<input checked="" type="checkbox"/> 178010	180	40,5 x 19 x 16,5	
<input checked="" type="checkbox"/> 178011	200	42 x 21 x 18	
<input checked="" type="checkbox"/> 178012	240	46 x 25 x 22,5	

DE	STREUER
EN	SHAKER
IT	SPARGITORE
ES	ESPARCIDOR

Material: Aluminium  
• Mit Schraubdeckel

Made of aluminium  
• With screw cap

#	Ø mm	↑ mm	
198890	80	190	



DE	POMMES FRITES / ABTROPFSCHÜSSEL
EN	FRENCH FRIES COLANDER
IT	COLAFRITTO PER PATATINE FRITTE
ES	COLADOR PATATAS FRITAS

Material: Edelstahl  
• Mit Griffen  
• Abnehmbare Auffangschale

Made of stainless steel  
• With handles  
• Detachable drip tray

#	Ø mm	↑ mm	
198891	410	140	



DE	KARTOFFELSTAMPFER
EN	POTATO MASHER
IT	SCHIACCIAPATATE
ES	PRENSADOR DE PATATAS

Material: Edelstahl  
• Extra schwere Qualität

Made of stainless steel  
• Extra heavy quality

#	↗ mm	
198892	580	

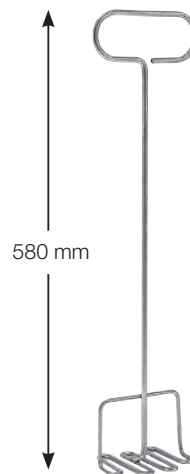

DE	RÜHRSPATELN
EN	MIXING PADDLES
IT	SPATOLE
ES	ESPÁTULAS

Material: PP, weiß  
• Hitzebeständig bis 100°C  
• Perforiert

Made of PP, white  
• Heat resistant up to 100° C  
• Perforated

#	↗ mm	
228128	1000	
228129 *	1200	





© africa-studio.com, Olga Yastremka and Leonid Yastremsky | stock.adobe.com

DE	VIERKANTREIBE / UNIVERSALREIBE
EN	GRATER
IT	GRATTUGIA UNIVERSALE
ES	RALLADOR UNIVERSAL



- Material: Edelstahl
- 4 verschiedene Reibeflächen
  - Inklusive rutschhemmende Füße

- Made of stainless steel
- 4 different grating surfaces
  - Including anti-slip feet

#	↓ mm	→ mm	↑ mm	
151145	85	110	250	



DE	GEMÜSEHOBEL / MANDOLINE
EN	SLICER FOR VEGETABLES
IT	MANDOLINA AFFETTAVERDURE
ES	CORTADORA DE VERDURAS











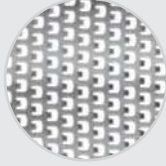

- Material: Edelstahl
- Inklusive 3 Messer, 2 / 3 / 6 mm

- Made of stainless steel
- Including 3 cutting blade units, 2 / 3 / 6 mm

#	↔ mm	⚖️ kg	
151195	335 x 110 x 50	0,62	



DE	REIBEN
EN	GRATERS
IT	GRATTUGIE
ES	RALLADORES

		#		↔ mm
<b>1. Hobel / slicer</b> 	Schokolade, harter Käse, Gurken, Knoblauch, Ingwer, Trüffel, Butter / Chocolate, hard cheeses, cucumbers, garlic, ginger, truffles, butter	292000 ☑		75 x 320
		292001 ☑		75 x 320
<b>2. fein / fine</b> 	Zitrusfrüchte, Gewürze / Citrus zest, spices	292002 ☑		45 x 390
		292003 ☑		75 x 320
<b>3. grob / coarse</b> 	Käse, Karotten, Kokos, Schokolade / Hard cheeses, carrots, coconut, chocolate	292004 ☑		45 x 390
		292005 ☑		75 x 320
<b>4. sehr grob / extra coarse</b> 	Zucchini, Kartoffeln, weicher Käse, Karotten, Äpfel, Kohl / Zucchini, potatoes, soft cheeses, carrots, apples, cabbage	292006 ☑		45 x 390
		292007 ☑		75 x 320
<b>5. Stern / star</b> 	harter Käse, Zitrusfrüchte, Knoblauch, Muskatnuss / hard cheeses, citrus zest, garlic, nutmeg	292008 ☑		45 x 390



Silikon-Stabilitätsfuß für stabiles Arbeiten / Silicone stability foot for stable work.

Säuregeätzte Klingen sorgen für eine scharfe Schneidefläche, die länger scharf bleibt / Acid etched blades for a super sharp cutting surface that stays sharp longer.

Ergonomischer Griff, mit Aufhängeloch / with comfortable ergonomic handle, with hanging hole.





DE	RÜHRSCHÜSSELN	
EN	MIXING BOWLS	
IT	CIOTOLE TONDE	
ES	CALDEROS SEMIESFÉRICOS	

Material: PP, natur-weiß

- Bruchsicher
- Hygienisch
- Stapelbar
- für Mikrowellengeräte geeignet

Made of PP, natural white

- Break resistant
- Hygienic
- Stackable
- Suitable for microwave

#	↕ l	Ø mm	↑ mm
290000	1,0	190	79
290010	2,5	240	115
290020	4,5	280	135
290030	6,0	325	147
290040	9,0	360	165
290050	13,0	400	185



DE	DECKEL
EN	LIDS
IT	COPERCHI
ES	TAPAS

Material: PP

Made of PP

#	für / for #	Ø mm
290070	290000 (1,0 l)	190
290071	290010 (2,5 l)	240
290072	290020 (4,5 l)	280
290073	290030 (6,0 l)	325
290074	290040 (9,0 l)	360
290075	290050 (13,0 l)	400



DE	KASSEROLLE	
EN	SAUCEPAN	
IT	CARAFFA GRADUATA PER MICROONDE	
ES	CAZO DE POLIPROPILENO PARA MICROONDAS	

Material: PP, weiß

- Mit geprägter Skala in Innenseite
- Blauer Skalendruck auf der Außenseite
- Bruchsicher
- Hygienisch
- für Mikrowellengeräte geeignet

Made of PP, with

- Inside scale
- Blue stamped litre and ml scale outside
- Break resistant
- Hygienic
- Suitable for microwave

#	↗ mm	Ø mm	↑ mm	↕ l
290200	335	190	120	2,0

**i** Ausgießer beidseitig somit für Links- und Rechtshänder geeignet. / Pour spouts on both sides, thus for left- and right-handers.

DE	FRÜCHTE ABLAUF-SET, RUND
EN	FRUIT STRAINER SET, ROUND
IT	SET SCOLAFRUTTA
ES	JUEGO DE COLADOR PARA FRUTA

Material: PP, weiß

- Bruchstabil
- Hygienisch
- Sieb mit praktischem Griff
- Alle Komponenten einzeln erhältlich

Made of PP, white

- Break resistant
- Hygienic
- Stackable, strainer with 2 handles
- Each part available separately



#		Ø mm	↓ ↑ l
290040	Schüssel/ bowl	360	9,0
200022	Seiher/strainer	280	

DE	SEIHER
EN	STRAINER
IT	COLAPASTA IN PLASTICA
ES	COLADOR, PLÁSTICO

Material: PP, weiß

- 2 Muschelgriffe
- Passende Schüssel  
# 221026+290040

Made of PP, white

- With 2 shell shaped handles
- Corresponding bowl  
# 221026+290040



#	↑ Ø mm	↓ Ø mm	↑ mm
200022	360	280	185

DE	RÜHRSCHÜSSEL
EN	MIXING BOWL
IT	CIOTOLA IN PLASTICA
ES	CALDERO BOL, PLÁSTICO

Material: ABS, weiß

- Ausgießer
- Praktischem Handgriff
- Ringfuß, antirutsch

Made of ABS, white

- Sprout
- convenient handle
- Nonslip base



#		Ø mm	↓ ↑ l
290300	Schüssel/ Bowl	240	4,25

DE	ZUTATENBEHÄLTER / VORRATSBEHÄLTER
EN	FOOD STORAGE CONTAINERS WITH LIID
IT	CONTENITORI CON COPERCHIO
ES	CONTENEDORES CON TAPA



Material: PP

- Mit Klappdeckel (PC)
- Spülmaschinengeeignet

Made of PP

- With lid (PC)
- Dishwasher proof



#	↔ mm	↓ ↑ l
230150	500 x 160 x 95	4 x 0,7
230160	500 x 160 x 95	6 x 0,45

DE	RÜHRSCHÜSSELN	<b>SST</b>
GB	MIXING BOWLS	
IT	BACINELLE CONICHE	
ES	CALDEROS CÓNICOS	



Material: Edelstahl

- **Konische Form**
- Mit abgerundetem Rand
- Glatter Boden
- Gute Standfestigkeit
- Stabil und griffig
- Stapelbar

Made of stainless steel

- **Conical shape**
- With rolled edge
- Smooth bottom
- Good stability
- Stable and non-slip
- Stackable



#	Ø mm	l
199002	160	0,5
199003	180	0,9
199004	200	1,2
199005	225	1,6
199006	235	2,0
199007	280	3,0
199008	320	5,0
199009	360	7,0
199010	395	8,2

DE	SCHLAGSCHÜSSELN	<b>SST</b>
GB	MIXING BOWLS	
IT	BACINELLE SEMISFERICHE	
ES	CALDEROS SEMIESFÉRICOS	



Material: Edelstahl

- **Runde Form**
- Mit abgerundetem Rand
- Glatter Boden
- Gute Standfestigkeit
- Stabil und griffig
- Stapelbar

Made of stainless steel

- **Hemispherical shape**
- With rolled edge
- Smooth bottom
- Good stability
- Stable and non-slip
- Stackable



#	Ø mm (innen/inside)	l
199000	125	0,3
199011	140	0,5
199012	165	0,9
199013	185	1,25
199014	200	1,85
199015	230	2,6
199017	255	3,2
199018	280	4,5
199019	330	6,7

DE	MESSBECHER
EN	MEASURING CUPS
IT	CARAFFE GRADUATE
ES	JARRAS GRADUADAS

Material: PP, Farbe natur

- Mit geprägter Skala und blauer Skala
- Liter- und Milliliter-Einteilung
- Bis 95°C erhitzen

Made of PP, translucent

- With stamped and blue scale
- Litre and ml scale
- Temperature resistant up to 95°C



# 206010

#	mit geschlossenem Griff / with closed handle	📏 l	
206010*	ohne Griff / without handle	0,12	
200011	mit geschlossenem Griff / closed handle	0,5	
200012	mit geschlossenem Griff / closed handle	1,0	
200013	mit geschlossenem Griff / closed handle	2,0	
200014	mit geschlossenem Griff / closed handle	3,0	
200015	mit geschlossenem Griff / closed handle	5,0	

#	mit offenem Griff / with open handle	📏 l	
200010*	mit offenem Griff / open handle	0,25	
206011	mit offenem Griff / open handle	0,5	
206012	mit offenem Griff / open handle	1,0	
206013	mit offenem Griff / open handle	2,0	
206014	mit offenem Griff / open handle	3,0	
206015	mit offenem Griff / open handle	5,0	

\* nur geprägte Skala

\* only with stamped scale



# 200010

#	Deckel für # / Lid for #	
206112	200012 + 206012 / 1,0 l	
206113	200013 + 206013 / 2,0 l	
206114	200014 + 206014 / 3,0 l	
206115	200015 + 206015 / 5,0 l	



Material: PP, Farbe natur

- Mit offenem Griff
- Stapelbar
- Liter- und Milliliter-Einteilung
- Bis 95°C erhitzen

Made of PP, translucent

- With open handle
- Stackable
- With litre- and ml-scale
- temperature resistant up to 95°C

#	📏 l	
200149	0,5	
200150	1,0	
200170	2,0	
200179	3,0	



DE	MESSBECHER-SET – mit geschlossenem Griff / inklusive Deckel
EN	SET OF MEASURING CUPS – with closed handle / including lid
IT	SET DI CARAFFE GRADUATE
ES	SET DE JARRAS GRADUADAS

Material: PP, Farbe natur

- Mit geprägter Skala und blauer Skala
- Liter- und Milliliter-Einteilung
- Bis 95°C erhitzen

Made of PP, translucent

- With stamped and blue scale
- Litre and ml scale
- Temperature resistant up to 95°C



#		📏 l	
200408	mit geschlossenem Griff / closed handle	1,0	
200409	mit geschlossenem Griff / closed handle	2,0	



DE	FLACHBESEN	
EN	FLAT WHISK	
IT	FRUSTA PIATTA	
ES	BATIDOR PLANO	

- Speziell für das Unterheben von schweren Massen und Saucen, Cremes und Mehl
  - Auch bestens für Fettgebäck geeignet
  - Especially for mixing heavy masses and sauces, creams and flour
  - Also ideally suitable for fatty pastries
- Drahtstärke: 2,0 mm**      **Wire thickness: 2.0 mm**

#	↗ mm	Drähte / Wires	
<input checked="" type="checkbox"/> 170079	270	4	



DE	SCHNEEBESEN	
EN	WHISKS	
IT	FRUSTE	
ES	BATIDORES	

- Schwarzer thermoplastischer Griff
  - Drähte aus Edelstahl
  - Wasserdichter Griff
  - Mit Aufhängeöse
  - Schwere Qualität
  - Hitzebeständig bis 200°C
  - Black thermoplastic handle
  - Wires made of stainless steel
  - Waterproof handle
  - With suspension eye
  - Heavy quality
  - Heat resistant up to 200°C
- Drahtstärke: 1,6 mm**      **Wire thickness: 1.6 mm**

#	↗ mm	Drähte / Wires	
<input checked="" type="checkbox"/> 170080	250	24	
<input checked="" type="checkbox"/> 170081	300	24	
<input checked="" type="checkbox"/> 170082	350	24	
<input checked="" type="checkbox"/> 170083	400	24	
<input checked="" type="checkbox"/> 170084	450	24	
<input checked="" type="checkbox"/> 170085	500	24	



- Material: Edelstahl
- Handlicher Griff
  - Für leichte Massen
  - Made of stainless steel
  - Easy-to-hold handle
  - For light masses
- Drahtstärke: 1,6 mm**      **Wire thickness: 1.6 mm**

#	↗ mm	Drähte / Wires	
<input checked="" type="checkbox"/> 170040	250	24	
<input checked="" type="checkbox"/> 170041	300	24	
<input checked="" type="checkbox"/> 170042	350	24	
<input checked="" type="checkbox"/> 170043	400	24	
<input checked="" type="checkbox"/> 170044	450	24	



- BALLONFORM
  - Schwarzer Kunststoffgriff "Exoglass"
  - Drähte aus Edelstahl
  - Wasserdichter Griff
  - Griffbund verhindert abrutschen
  - Hitzebeständig bis 220 °C
  - BALLOON-SHAPE
  - Black plastic handle "Exoglass"
  - Wires made of stainless steel
  - Waterproof handle
  - Handle band prevents slipping
  - Heat resistant up to 220 °C
- Drahtstärke: 1,5 mm**      **Wire thickness: 1.5 mm**

#	↗ mm	Drähte / Wires	
170016	450	24	

DE	RÜHRBESEN	
EN	WHISKS	
IT	FRUSTE	
ES	BATIDORES	

- |   |   |
|---|---|
| <ul style="list-style-type: none"> <li>• Schwarzer thermoplastischer Griff</li> <li>• Drähte aus Edelstahl</li> <li>• Wasserdichter Griff</li> <li>• Mit Aufhängeöse</li> <li>• Schwere Qualität</li> <li>• Hitzebeständig bis 200°C</li> </ul> <p><b>Drahtstärke: 2,0 mm</b></p> | <ul style="list-style-type: none"> <li>• Black thermoplastic handle</li> <li>• Wires made of stainless steel</li> <li>• Waterproof handle</li> <li>• With suspension eye</li> <li>• Heavy quality</li> <li>• Heat resistant up to 200°C</li> </ul> <p><b>Wire thickness: 2.0 mm</b></p> |
|---|---|



#	↗ mm	Drähte / Wires
<input checked="" type="checkbox"/> 170070	250	16
<input checked="" type="checkbox"/> 170071	300	16
<input checked="" type="checkbox"/> 170072	350	16
<input checked="" type="checkbox"/> 170073	400	16
<input checked="" type="checkbox"/> 170074	450	16
<input checked="" type="checkbox"/> 170075	500	16

- |   |   |
|---|---|
| <p>Material: Edelstahl</p> <ul style="list-style-type: none"> <li>• Handlicher Griff</li> <li>• Für schwere Massen</li> </ul> <p><b>Drahtstärke: 2,3 mm</b></p> | <p>Made of stainless steel</p> <ul style="list-style-type: none"> <li>• Easy-to-hold handle</li> <li>• For heavy masses</li> </ul> <p><b>Wire thickness: 2.3 mm</b></p> |
|---|---|



#	↗ mm	Drähte / Wires
<input checked="" type="checkbox"/> 170050	350	16
<input checked="" type="checkbox"/> 170051	400	16
<input checked="" type="checkbox"/> 170052	450	16
<input checked="" type="checkbox"/> 170053	500	16
<input checked="" type="checkbox"/> 170054	600	16

- |   |  |
|---|--|
| <ul style="list-style-type: none"> <li>• Schwarzer Kunststoffgriff "Exoglass"</li> <li>• Drähte aus Edelstahl</li> <li>• Wasserdichter Griff</li> <li>• Griffbund verhindert abrutschen</li> <li>• Hitzebeständig bis 220 °C</li> </ul> <p><b>Drahtstärke: 1,8 mm</b></p> | <ul style="list-style-type: none"> <li>• Black plastic handle "Exoglass"</li> <li>• Wires made of stainless steel</li> <li>• Waterproof handle</li> <li>• Handle band prevents slipping</li> <li>• Heat resistant up to 220 °C</li> </ul> <p><b>Wire thickness: 1.8 mm</b></p> |
|---|--|



#	↗ mm	Drähte / Wires
170010	250	12
170011	300	16
170012	350	16
170013	400	16
170014	450	18
170015	500	18



DE	PASTETENAUSSTECHE
EN	CUTTERS FOR PATE
IT	TAGLIAPASTA PER PATÈ
ES	CORTADOR PARA PATÉ

Material: Edelstahl

- Materialstärke: 0,4 mm
- Höhe: 50 mm

Made of stainless steel

- thickness: 0,4 mm
- Height: 50 mm



#	↔ mm	⊥ mm	
199892	66	40	
199893	Pastetenhalter/mould	40	
199894	73	47	
199895	Pastetenhalter/mould	45	



DE	STREUER / GEWÜRZDOSE / ZUCKERSTREUER	SST
EN	SUGAR DISPENSERS	
IT	SPARGIZUCCHERO	
ES	ESPARCIDORES DE AZÚCAR CON TAMIZ	

Material: Edelstahl

Made of stainless steel

#		↑ mm	∅ mm	⊥ mm	⊥
199026	mit Sieb / with meshes	76	56	0,8	0,15
199027	mit Sieb / with meshes	89	68	0,8	0,25
199028	mit Sieb / with meshes	127	68	0,8	0,35
199059	kleine Lochung / small holes	79	56	1,5	0,15
199060	kleine Lochung / small holes	91	68	1,5	0,25
199061	kleine Lochung / small holes	129	68	1,5	0,35
199065	große Lochung / large holes	79	56	2,5	0,15
199063	große Lochung / large holes	91	68	2,5	0,25
199064	große Lochung / large holes	129	68	2,5	0,35



199026 / 199059 / 199065  
mit Bajonettverschluss /  
with bayonet lock



alle anderen  
Größen mit Dreh-  
verschluss /  
with screw lock



DE	BACKHANDSCHUHE SILIKON	
EN	BAKING MITTENS SILICONE	
IT	GUANTI DA FORNO IN SILICONE	
ES	GUANTES MANOPLAS DE SILICONA PARA HORNO 3 DEDOS	

100% Silikon

- Hitzebeständig bis +250°C / max. 15 sec.
- flexibles Material
- Wasserdicht
- Spülmaschinengeeignet
- Hygienisch
- Sterilisierbar

100% silicone

- Heat resistant up to +250°C / max. 15sec.
- flexible material
- Waterproof
- Dishwasher safe
- Hygienic
- can be sterilised



#	↗ mm	→ mm
310031	285	160
310032	385	180

DE	GASTROHANDSCHUH „SILIKON“	
EN	GASTRO MITTENS „SILICONE“	
IT	GUANTI GASTRO IN „SILICONE“	
ES	MANOPLAS GASTRO „SILICONA“	

Material: Silikon mit Baumwollfutter

- für Rechts- und Linkshänder
- Zwischen Daumen und Zeigefinger verstärkt
- Wasserdicht
- flexibles Material
- Hitzebeständig bis + 250°C / max. 15 sec.
- Handreinigung max. 30–40°C

Made of silicone with cotton lining

- for right- and left-handers
- Reinforced between thumb and index finger
- Waterproof
- flexible material
- Heat resistant up to + 250 °C / max. 15 sec.
- Manual cleaning max. 30–40°C



#	↗ mm	→ mm
<input checked="" type="checkbox"/> 310099	380	150

DE	BACKHANDSCHUH NEOPREN	
EN	BAKING MITTENS NEOPRENE	
IT	GUANTI DA FORNO IN NEOPRENE	
ES	MANOPLAS NEOPRENE PARA HORNO	

Material: Neopren, schwarz

- Für Rechts- und Linkshänder
- Hitzebeständig bis + 250 °C / max. 15 sec.
- rutschfest
- Wasserabstoßendes und fleckenresistentes Material
- Handreinigung max. 30–40°C

Made of neoprene, black

- for right- and left-handers
- Heat resistant up to + 250 °C / max. 15 sec.
- non-slip
- Water repellent and stain resistant material
- Manual cleaning max. 30–40°C



#	↗ mm	→ mm
310085	350	145

 Weitere Backhandschuhe auf Seite 168 – 171. / Other baking mittens on page 168 – 171.





DE	KARAMELLISIERER / GASTRO-GASBRENNER
EN	PROFESSIONAL CHEF'S BLOWTORCH
IT	CANNELLO
ES	FLAMBEADOR

Nachfüllbarer Gastro-Gasbrenner zum Veredeln von Fleisch, Fisch und anderen kulinarischen Speisen.

- Leistungsstarke Fackelflamme mit rostfreiem Senkkopf für eine gleichmäßig verteilte Flamme (mit Feststellschraube).
- Feines, hochtemperaturbeständiges Drahtgeflecht am Senkkopf. Für ein besonders zartes und schmackhaftes Garergebnis.
- Profi-Gasbrenner mit Selbstentzündung. Hochleistungsdesign mit Metallgasbehälter, ausgestattet mit Kindersicherungsschalter, einstellbarer Flammkontrolle, auszieh-barem Metalldrahtfuß, einfach und sicher zu bedienen.
- Fassungsvermögen / Gasbehälters: 102 ml
- Empfohlener Kraftstoff: Feuerzeugflüssigkeit
- Betriebstemperatur: ca. 1100°C

Refillable professional culinary blowtorch for refining meat, fish and other culinary dishes.

- Powerful torch flame with stainless steel spout for an evenly distributed flame (with locking screw).
- Fine, high-temperature resistant wire mesh at the spout. For a particularly tender and tasty cooking result.
- Professional culinary blowtorch with auto ignition. High-performance design with metal gas container, equipped with child safety switch, adjustable flame control, extendable metal wire at the base for a firm stand, easy and safe to use.
- Capacity of the gas container: 102 ml
- recommended fuel: butane lighter fuel
- Operating temperature: ca. 1100°C



bis zu  
up to  
1100°C  
Flammentemperatur /  
Flame temperature



Flamme einstellbar /  
Adjustable flame



winddicht / windproof



nachfüllbar /  
refillable  
Verbindungsventil /  
Connector valve

#	mm	g
<input checked="" type="checkbox"/> 153093	175 x 75 x 215	440



DE	KARAMELLISIERER / GASBRENNER
EN	BLOWTORCH / CARAMELIZER
IT	CANNELLO
ES	FLAMBEADOR

Für Crème Brulée, Karamellisieren von Speisen aller Art.

- Einfaches und schnelles Befüllen mit Feuerzeuggas
- Gehäuse aus Stahl, Fuß aus Kunststoff
- Einfach zu bedienen
- Mit Kindersicherung
- verschleißfreie Piezo-Zündung
- Flamme einstellbar
- Flamme bis ca. 1450 °C

For crème brulée and caramelizing all kinds of food.

- Easy and quick refill with lighter gas
- Body made of steel
- Easy to use
- child-proof safety lock system
- Self-igniting Piezo Ignition
- Safety adjustable flame
- flame up to 1450 °C



# 153090



# 153091

#	↑ mm	Ø mm
☑ 153090	165	45
☑ 153091	151	32



DE	KARAMELLISIERER / GASBRENNER-AUFSATZ
EN	CARAMELIZER / BLOWTORCH HEAD
IT	CANNELLO
ES	FLAMBEADOR

Für Crème Brulée, Karamellisieren von Speisen aller Art.

- Einfach zu bedienen
- Mit Kindersicherung
- verschleißfreie Piezo-Zündung
- Flamme einstellbar
- Flamme bis ca. 1450 °C

For crème brulée and caramelizing all kinds of food.

- Easy to use
- child-proof safety lock system
- Self-igniting Piezo Ignition
- Safety adjustable flame
- flame up to 1450 °C



#	↔ mm
☑ 153092	155

**i** direkter Anschluss an handelsübliche Gaskartuschen mit EU-Schraubgewinde „UNE F 7/16“ (Typ D) / Direct connection to standard gas cans with EU screw thread „UNE F 7/16“ (Type D)

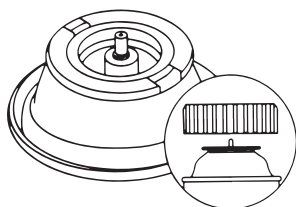

DE	CREME-FORMEN	SST
EN	YULE LOG MOULDS	
IT	STAMPI PER TRONCHETTO, TONDI	
ES	MOLDES MEDIA CAÑA PARA CREMA REDONDOS	



Material: Edelstahl

Made of stainless steel

**Ausführung: geschlossene Form**

**model: self-contained**

**Design: rund**

**design: round**

#	↗ mm	→ mm	↑ mm
193030	500	50	37
193031	500	60	45
193032	500	70	50
193033	500	80	62



DE	DARIOLFORMEN
EN	CREAM TART MOULDS (DARIOL MOULDS)
IT	STAMPI PER DARIOLE
ES	MOLDES PARA DARIOLES

Material: Edelstahl

Made of stainless steel

#	↑ Ø mm	↓ Ø mm	↕	↑ mm
199409	47	35	45	45
199410	54	37	70	50
199411	65	43	100	65
199412	84	60	150	80

DE	DESSERT- / TORTENRINGE	SST
EN	DESSERT- / TART RINGS	
IT	ANELLI PER TORTE E DESSERT	
ES	AROS PARA TARTAS	

Material: Edelstahl

Made of stainless steel

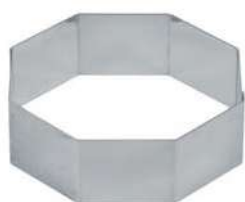

#		↔ mm	↑ mm
155060	Achteck / octagon	Ø: 160	50
155100	Sechseck / hexagon	Ø: 160	50
155110	Sechseck / hexagon	Ø: 180	50
155120	Sechseck / hexagon	Ø: 200	50
155200	Herz / heart	Ø: 180	50
155210	Herz / heart	Ø: 200	50
155220	Herz / heart	Ø: 230	50
155300	Dreieck / triangle	160	50
155310	Dreieck / triangle	180	50
155320	Dreieck / triangle	200	50



# 155100 – 155120



# 155200 – 155220



# 155300 – 155320

DE	DESSERT- / TORTENRINGE	<b>SST</b>
EN	DESSERT- / TART RINGS	
IT	ANELLI PER TORTE E DESSERT	
ES	AROS PARA TARTAS	

Material: Edelstahl

Made of stainless steel

#		↗ mm	↑ mm	↕ mm
155330	Tropfen / tear-drop	160	50	1,2
155331	Tropfen / tear-drop	180	50	1,2
155332	Tropfen / tear-drop	200	50	1,2
155340	Dreieck, gewölbt / triangle, convex	160	50	1,2
155341	Dreieck, gewölbt / triangle, convex	180	50	1,2
155342	Dreieck, gewölbt / triangle, convex	200	50	1,2
155350	Viereck, gewölbt / square, convex	140	50	1,0
155351	Viereck, gewölbt / square, convex	160	50	1,0
155352	Viereck, gewölbt / square, convex	180	50	1,0

# 155330 – 155332



# 155340 – 155342



# 155350 – 155352



DE	DESSERTRING
EN	DESSERT RING
IT	ANELLI PER DOLCI
ES	AROS PARA POSTRES

Material: PS, elfenbein

- Nicht zum Backen im Ofen geeignet!

Made of PS, ivory

- Not suitable for baking in ovens!

#	Ø mm	↑ mm
200950	75	30

**NICHT zum Backen geeignet!**  
**NOT for baking!**



Material: Reinaluminium,

- Nahtgeschweißt
- Extra stark

Made of pure aluminium

- Welded seam
- Extra strong

#	Ø mm	↑ mm	↕ mm
156075	75	30	2
156076	75	40	2



**“MINI”**

Material: Edelstahl

- Materialstärke: 0,8 mm

**“MINI”**

Made of stainless steel

- thickness: 0,8 mm

#		↔ mm	↑ mm
155450	Rund / round	Ø 70	45
155451	Oval / oval	74 x 56	45
155452	Tropfen / drop	77 x 54	45
155453	Dreieck / triangle	68	45
155454	Herz / heart	55 x 67	45
155455	Sechseck / hexagon	54	45
155456	Quadrat / square	54	45





DE	PENDELSCHÄLER
EN	SWIVEL PEELER
IT	PELAPATATE
ES	PELADOR

Material: Metall  
 • Klinge rostfrei

Made of metal  
 • Blade stainless steel

#	→ mm	↗ mm	
<input checked="" type="checkbox"/> 260868	50	157	



DE	SPARSCHÄLER / QUERSCHÄLER
EN	SPEED PEELER
IT	PELAPATATE
ES	PELADOR

Material: Edelstahl

Made of stainless steel

#	→ mm	↗ mm	
<input checked="" type="checkbox"/> 260869	42	110	



DE	EIERTEILER
EN	EGG SLICER
IT	TAGLIA UOVA
ES	CORTADOR DE HUEVOS

Material: Aluminium  
 • Drähte aus Edelstahl  
 • Schneidet runde und ovale Scheiben

Made of aluminium  
 • Wires made of stainless steel  
 • Cuts round and oval slices

#	↗ mm	→ mm	↑ mm	
199361	135	79	29	



DE	EIERSTÜCKLER
EN	EGG CUTTER
IT	TAGLIA UOVA
ES	CORTADOR DE HUEVOS

Material: Aluminium  
 • Drähte aus Edelstahl  
 • Zum Teilen von hart gekochten Eiern in  
 6 gleiche Stücke

Made of aluminium  
 • Wires made of stainless steel  
 • For dividing hard boiled eggs into  
 6 equal pieces

#	↗ mm	→ mm	↑ mm	
199362	181	64	26	

DE	APFELTEILER
EN	APPLE SLICER
IT	TRANCIA SPICCHI PER MELA
ES	CORTADOR DE MANZANAS

Material: Aluminium

- Messer aus Edelstahl
- Zum Teilen in 10 gleiche Stücke und Entfernen des Kerngehäuses

Made of aluminium

- Blades made of stainless steel
- For dividing into 10 equal pieces and removing the core



#	↔ mm
199031	170 x 111 x 43

DE	APFELAUSSTECHE
EN	APPLE CORER
IT	LEVATORSOLI
ES	SACA CORAZÓN DE MANZANAS

Material: Edelstahl, schwarz

- Griff aus PP
- Für schnelles Ausstechen des Kerngehäuses

Made of stainless steel, black

- Handle made of PP
- quick and clean coring



#	↗ mm	Ø mm
<input checked="" type="checkbox"/> 199032	200	16

DE	KNOBLAUCHPRESSE
EN	GARLIC PRESS
IT	SPREMIAGLIO
ES	PRENSA DE AJO

Material: Aluminium

Made of aluminium



#	↔ mm
199364	152 x 25 x 31

DE	OLIVENTSTEINER
EN	OLIVE STONER
IT	SNOCCIOLATORE PER OLIVE
ES	DESHUESADOR DE ACEITUNAS

Material: Aluminium

- Für große und kleine Oliven

Made of aluminium

- For big and small olives



#	↔ mm
199365	169 x 105 x 27



DE	FLASCHEN- UND DOSENÖFFNER
EN	BOTTLE AND CAN OPENER
IT	APRIBOTTIGLIE E APRISCATOLE
ES	ABREBOTELLAS Y ABRELATAS

Material: verchromter Stahl  
 • Schwarzer Kunststoffgriff  
 • Leichte Ausführung

Made of chrome-plated steel  
 • Black handle made of plastic

#	→ mm	⚖ kg
<input checked="" type="checkbox"/> 151190	200	0,25



DE	PROFI-DOSENÖFFNER
EN	PROFESSIONAL CAN OPENERS
IT	APRISCATOLE INDUSTRIALI
ES	ABRELATAS INDUSTRIAL

#		↗ mm	⚖ kg
151170	Vernickelter Stahl / Nickel-plated steel	600	2,5
151175	Edelstahl / Stainless steel	600	2,5

151171	Ersatzmesser / Spare blade		
151172	Ersatzzahnrad / Spare gear wheel		



DE	SALATSCHLEUDER
EN	SALAD SPINNER
IT	CENTRIFUGA PER INSALATA
ES	CENTRIFUGADORA PARA ENSALADA

- Material: PP
- Für Salat, Obst und Gemüse
  - Sieb abnehmbar

- Made of PP
- For salad, fruits and vegetables
  - Sieve removable

12 Liter: für 2–3 Salatköpfe  
25 Liter: für 4–5 Salatköpfe

12 liters: for 2–3 heads of lettuce  
25 liters: for 4–5 heads of lettuce

#	↑ mm	Ø mm	⚙ l
290160	435	320	12,0
290170	515	420	25,0



DE	TOMATENSCHNEIDEGERÄT	SST
EN	TOMATO SLICER	
IT	AFFETTA POMODORI	
ES	CORTA TOMATE	

- Material: Edelstahl
- Schnittbreite: 5,5 mm
  - Einfache Bedienung
  - Leicht zu reinigen
  - Aus hochwertigem Edelstahl
  - Ergonomischer Hartkunststoff Griff
  - GummifüÙe für eine sichere Standfestigkeit

- Made of stainless steel
- Slices 5,5 mm
  - Simple operation
  - Easy to clean
  - Made of premium stainless steel
  - Ergonomic handle made of plastic rubber feet for secure stability

#	↔ mm
151065	450 x 210 x 210
151066	Ersatzmesser / Spare blades





DE	SAHNESPENDER	
EN	CREAM WHIPPERS	SST
IT	SIFONI PER PANNA	
ES	SIFONES PARA NATA	

Zum Zubereiten von Sahne, Mousses, Desserts, kalten Schäumen und Saucen.

- Inhalt bleibt im Kühlschrank bis zu 14 Tage haltbar
- Inklusive 3 Spritzdüsen aus Edelstahl und 1 Reinigungsbürste
- Benötigt Sahnekapseln (N<sub>2</sub>O) (nicht im Lieferumfang enthalten)

For the preparation of whipped cream, mousses, desserts, cold espumas and sauces.

- The contents can be stored in the fridge for up to 14 days
- Includes 3 stainless steel nozzles and 1 cleaning brush
- Requires cream chargers (N<sub>2</sub>O) (not included in the package)



#	l	
196050	0,5	
196060	1,0	

DE	SAHNEKAPSELN	
EN	CREAM CHARGERS	SST
IT	CARTUCCE (PER SIFONE PER PANNA)	
ES	CARGAS PARA SIFÓN	

Universalkapseln – für alle Sahnespender geeignet.

- Inhalt / Füllgewicht: 7,6 g (+/-0,4 g) N<sub>2</sub>O – Distickstoffmonoxid.

Universal cream whipper cartridges – suitable for all cream whippers

- 7,6 g (+/- 0,4 g) N<sub>2</sub>O – Nitrous Oxide



#	Menge / amount	
196015	10	
196020	24	
196030	50	

**i** Nicht für Luftfracht zugelassen. / Not permitted for transport via airfreight. Innerhalb von 5 Jahren ab dem Produktionsdatum zu verwenden. / Best before 5 years after production date.

DE	KONTAKTGRILL
EN	CONTACT GRILL
IT	GRILL A CONTATTO
ES	GRILL DE CONTACTO

- Edelstahlgehäuse
  - Gusseiserne Backplatte
  - Einstellbare Plattenhöhe
  - Herausnehmbare Auffangschale
  - Einstellbare Griffspannung
  - Batteriebetriebener und herausnehmbarer akustischer Timer\*
- Stainless steel housing
  - Cast iron plate
  - Height of plate may be adjusted
  - Removable grease collection tray
  - Adjustable handle tension
  - Battery-operated and removable timer\*, including acoustic signal



#	150900 *	150910 *	150920 *	150930 *
	<b>Kontaktgrill – klein gewellt / gewellt</b>	<b>Kontaktgrill – klein gewellt / glatt</b>	<b>Kontaktgrill – gross gewellt / gewellt</b>	<b>Kontaktgrill – gross gewellt / glatt</b>
Grillfläche / grill area mm	240 x 260	240 x 260	290 x 380	290 x 380
↓ mm	420	420	420	420
→ mm	290	290	410	410
↑ mm	245	245	245	245
	2000 W 50 / 60 Hz / 230 Volt	2000 W 50 / 60 Hz / 230 Volt	2400 W 50 / 60 Hz / 230 Volt	2400 W 50 / 60 Hz / 230 Volt
°C	60 bis 300	60 bis 300	60 bis 300	60 bis 300

DE	REINIGUNGSBÜRSTE
EN	CLEANING BRUSH
IT	SPAZZOLA DI PULIZIA
ES	CEPILLO DE LIMPIEZA

- Holzgriff
  - Borstenfläche ca. 13 x 2,5 cm
- Wooden handle
  - Bristle area approx. 13 x 2.5 cm

#		↗ mm
<input checked="" type="checkbox"/> 120950	Messingdraht / Brass wire	285
<input checked="" type="checkbox"/> 120960	Stahldraht / Carbon steel	285





DE	WAFFEL-EISEN MIT DIGITALEM TIMER
EN	WAFFLE MAKERS WITH DIGITAL TIMER
IT	PIASTRE PER WAFFLE CON TIMER DIGITALE
ES	GOFRERAS PROFESIONALES CON TEMPORIZADOR DIGITAL

- Edelstahlgehäuse
  - Mit isoliertem Griff
  - Abnehmbare Fettauffangschale
  - Gusseiserne Backplatte, fest montiert
  - Schnelle und zweiseitige Heizungsversorgung
  - Gleichmäßige Temperaturverteilung
  - Heizung regelbar (60° bis 300°C)
  - Batteriebetriebener und herausnehmbarer akustischer Timer\*
- Stainless steel case
  - With insulated handle
  - Removable grease tray
  - Cast iron baking plate, permanently mounted
  - Fast and two-sided heating supply
  - Even temperature distribution
  - Heating adjustable (60° to 300°C)
  - Battery-operated and removable timer\*, including acoustic signal



# 150730



# 150710



# 150715

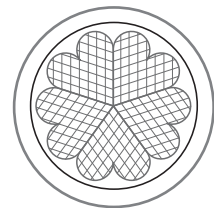
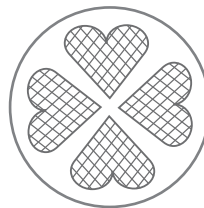
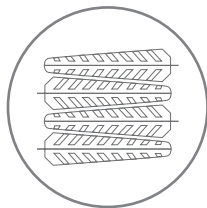

#	150730 *	150710 *	150715 *
	<b>„WAFFEL AM STIEL“ / “ON THE STICK”</b>	<b>„HERZ“ / “HEART”</b>	<b>„HERZ 5“ / “HEART 5”</b>
Waffeln / waffles	4 x	4 x ▲ 100	5 x ▲ 100
mm	55 x 215	↔ mm 165	Ø: 160
↓ mm	420	420	420
→ mm	300	300	300
↑ mm	295	295	295
⚡	1600 W 50 / 60 Hz / 230 Volt	1600 W 50 / 60 Hz / 230 Volt	1600 W 50 / 60 Hz / 230 Volt
°C	60° bis 300°C	60° bis 300°C	60° bis 300°C



DE	WAFFELSTÄBE
EN	WAFFEL-STICKS
IT	STECCHINI PER CIALDE SU STECCO
ES	PALITOS DE GOFRE EN UN PALO

Material: Birkenholz  
VE: 100 Stück

Made of birch wood  
100 pieces per unit

#	↔ mm	für / for
157745	300 x 4 x 4	# 150730

DE	WAFFEL-EISEN MIT DIGITALEM TIMER
EN	WAFFLE MAKERS WITH DIGITAL TIMER
IT	PIASTRE PER WAFFLE CON TIMER DIGITALE
ES	GOFRERAS PROFESIONALES CON TEMPORIZADOR DIGITAL

- Edelstahlgehäuse
  - Mit isoliertem Griff
  - Abnehmbare Fettauffangschale
  - Gusseiserne Backplatte, fest montiert
  - Schnelle und zweiseitige Heizungsversorgung
  - Gleichmäßige Temperaturverteilung
  - Heizung regelbar (60° bis 300°C)
  - Batteriebetriebener und herausnehmbarer akustischer Timer\*
- Stainless steel case
  - With insulated handle
  - Removable grease tray
  - Cast iron baking plate, permanently mounted
  - Fast and two-sided heating supply
  - Even temperature distribution
  - Heating adjustable (60° to 300°C)
  - Battery-operated and removable timer\*, including acoustic signal



# 150700

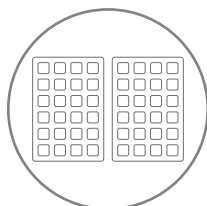

# 150720

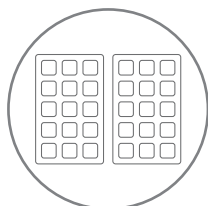

# 150790

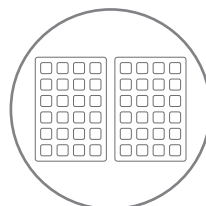

150700 *	150720 *	150790 *	#
<b>„QUADRO“</b>	<b>„BELGIEN“ / „BELGIUM“</b>	<b>„180° – drehbar“ „QUADRO“ / „180° – turnable“ „QUADRO“</b>	
2 x 100 x 185	2 x 100 x 185	2 x 110 x 185	Waffeln / waffles mm
420	420	540	↓ mm
300	300	305	→ mm
295	295	300	↑ mm
1600 W 50 / 60 Hz / 230 Volt	1600 W 50 / 60 Hz / 230 Volt	1800 W 50 / 60 Hz / 230 Volt	
60° bis 300°C	60° bis 300°C	60° bis 300°C	°C

DE	HEBEL-DOSIERSPENDER / TEIGDOSIERER – STANDGERÄT
EN	DOSING DISPENSER – TABLE STANDING UNIT
IT	DOSATORE A LEVA DA BANCO
ES	DOSIFICADOR DE MESA CON PALANCA

Speziell für Waffel- und Crêpes-Eisen

- Material: Edelstahl
- Hebelbedienung
- Höhenverstellbar
- Auslauf schwenkbar
- Dosierung einstellbar / ± 50 ml

Especially for waffle and crepe makers

- Made of stainless steel
- Lever operation
- Height adjustable
- Swivel spout
- Dosing adjustable / ± 50 ml

#	↔ mm	⬇ mm	⬇ l
152475	450 x 450 x 1000	4,0	

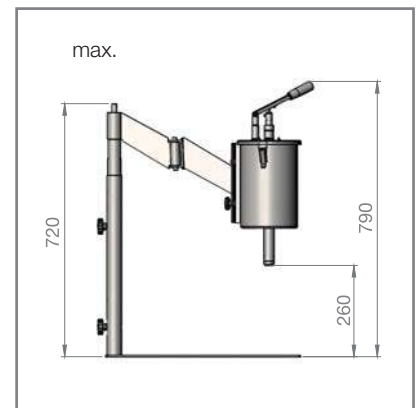
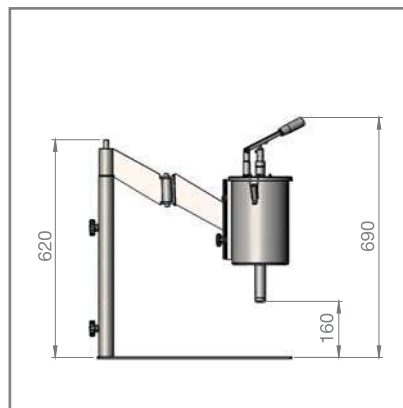
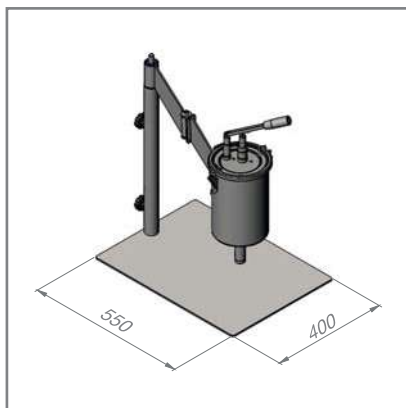

DE	TEIGDOSIERER
EN	DOUGH DISPENSER
IT	DOSATORE PER IMPASTI
ES	DOSIFICADOR PARA LA PASTA

Zum manuellen Dosieren von flüssigem Teig

- Behälter aus Edelstahl
- Inklusive Ständer

For manual dough portioning

- Body made of stainless steel
- Including stand

#	Ø mm	↑ mm	⬇ l
152975	167	395	2,0

DE	CREPES-EISEN
EN	CREPE MAKER
IT	CREPIERA
ES	CREPERA

- |  |   |
|--|---|
| <ul style="list-style-type: none"> <li>• Platten-Durchmesser: 40 cm</li> <li>• Teflon-Beschichtung</li> <li>• Außengehäuse Edelstahl</li> <li>• Temperatur stufenlos regelbar (140°C – 300°C)</li> <li>• Geringer Energieverbrauch</li> <li>• Inklusive Spatula und Verteiler</li> </ul> | <ul style="list-style-type: none"> <li>• Plate diameter: 40 cm</li> <li>• Teflon-coated</li> <li>• Outer casing made of stainless steel</li> <li>• Temperature continuously adjustable (140°C – 300°C)</li> <li>• Low energy consumption</li> <li>• Including spatula and spreader</li> </ul> |
|--|---|



#	150600	150610
∅ mm	400	400
↓ mm	400	445
→ mm	400	430
↑ mm	125	175
	2700 W 50 / 60 Hz 230 V	2700 W 50 / 60 Hz 230 V
°C	140 – 300	140 – 300



# 150600



# 150610

DE	CREPES-SCHIEBER
EN	CREPE SPREADERS
IT	STENDI CREPES
ES	RASTRILLOS DE CREPES

#	↔ mm	
157760	180 x 190	Holz / Wood
157770	180 x 180	Edelstahl / Stainless steel



14

DE	CREPES-WENDER
EN	CREPE SPATULA
IT	SPATOLA PER CREPE
ES	ESPÁTULA CREPE

#	↗ mm	→ mm
262636	360	34





DE	FRISCHHALTEFOLIE
EN	CLINGFILMS
IT	PELLICOLE PER ALIMENTI
ES	FILM ESTIRABLE

Material: lebensmittelechte Haftfolie (PE)  
 • Hervorragende Hafteigenschaften  
 • Atmungsaktiv geeignet auch zum Verpacken fetthaltiger Produkte

High quality clingfilm (PE)  
 • Excellent adhesive strength  
 • Breathable, usable also for greasy products

**“UNIFOL” - PERFORIERT**  
**Materialstärke: 12 µ**

**“UNIFOL” - PERFORATED**  
**Thickness: 12 µ**

#	Perforation / perforation mm	↗ m	
131030	250 x 250	500	
131040	300 x 300	500	
131050	350 x 350	500	
131060	400 x 400	500	
131070	450 x 450	500	
131080	600 x 600	350	



**“UNIFOL” - ENDLOS**  
**Materialstärke: 12 µ**

**“UNIFOL” - ENDLESS**  
**Thickness: 12 µ**

#	→ mm	↗ m	
132040	300	300	
132070	450	300	
132090	600	300	



**“EUROFOL” - ENDLOS**  
**Materialstärke: 10 µ**

**“EUROFOL” - ENDLESS**  
**Thickness: 10 µ**

#	→ mm	↗ m	
131800	290	300	
131801	440	300	
131802	590	300	



DE	FOLIEN-ABREISSVORRICHTUNG
EN	CLINGFILM TEAR-OFF-DISPENSERS
IT	PORTA PELLICOLE
ES	SOPORTE PARA FILM ESTIRABLE

Aus Metall, robuste Ausführung  
 • für Großrollen  
 • Mit Schneidekopf

Made of metal  
 • for jumbo-rolls  
 • With cutter

#	für / for ↔ mm	
158310	400	
158320	500	
158330	850	



DE	FOLIEN-ABREISSVORRICHTUNG
EN	CLINGFILM TEAR-OFF-DISPENSERS
IT	PORTA PELLICOLE
ES	SOPORTE PARA FILM ESTIRABLE

Aus Metall, **stabile Ausführung**

- Für perforierte Folien, max. 11 cm Ø
- Wandmontage oder als Tischgerät verwendbar, Breite ca. 20 cm

Made of metal, **strong execution**

- Only for perforated rolls, max. 11 cm Ø
- Wall fastening and tabletop unit, width approx. 20 cm

#		
158010	einfach / single	
158020	doppelt / double	



Aus Metall, **leichte Ausführung**

- Mit Säge, für Endlosfolien Ø max. 80 mm

Made of metal, **light execution**

- With saw, for endless rolls Ø max. 80 mm

#	für / for $\kappa$ - $\rightarrow$ mm	
158140	300	einfach / single
158150	450	einfach / single



Aus Metall, **stabile Ausführung mit Gegenstrebe**

- Mit Säge, für Endlosfolien Ø max. 80 mm

Made of metal, **strong execution with brace**

- With saw, for endless rolls Ø max. 80 mm

#	für / for $\kappa$ - $\rightarrow$ mm	
158110	300	einfach / single
158120	450	einfach / single
158130	600	einfach / single



Aus Metall, **stabile Ausführung mit Gegenstrebe**

- Mit Säge, für Endlosfolien Ø max. 80 mm

Made of metal, **strong execution**

- With saw, for endless rolls Ø max. 80 mm

#	für / for $\kappa$ - $\rightarrow$ mm	
158210	300	doppelt / double
158220	450	doppelt / double



**Material: Edelstahl, stabile Ausführung mit Gegenstrebe**

- Mit Säge, für Endlosfolien Ø max. 80 mm

**Made of stainless steel, strong execution**

- With saw, for endless rolls Ø max. 80 mm

#	für / for $\kappa$ - $\rightarrow$ mm	
158410	300	einfach / single
158420	450	einfach / single





DE	PIZZABALLENBOX / TEIGWANNE RECHTECKIG
EN	DOUGH CONTAINER RECTANGULAR
IT	CONTENITORE PER IMPASTO RETTANGOLARE
ES	BANDEJA PARA MASA RECTANGULAR

Material: PE, weiß

Made of PE, white

#	↔ mm	↑ mm	↓ mm
202170	600 x 400 x 75	565 x 365 x 70	14
202172	600 x 400 x 95	565 x 365 x 90	18
202173	600 x 400 x 130	565 x 365 x 120	24

DE	DECKEL FÜR PIZZABALLENBOX / TEIGWANNE
EN	LID FOR DOUGH CONTAINER
IT	COPERCHIO PER CONTENITORE IMPASTO
ES	TAPA DE LA BANDEJA PARA MASA

Material: PE, weiß

Made of PE, white

#	↗ mm	→ mm
202171	600	400

DE	PIZZA-OFENBÜRSTE
EN	PIZZA OVEN BRUSH
IT	SPAZZOLA PER FORNI PER PIZZA
ES	CEPILLO PARA HORNO DE PIZZA

Borsten aus Carbonstahl

Bristles made of carbon steel

• Mit Stiel

• With handle

#	↔ mm	
200644	1040	Besen mit Stiel / Broom with handle
200648	250	Besen / Broom
200649	1000	Ersatzstiel / Spare handle

DE	PIZZASCHAUFEL		
EN	PIZZA PEEL	ALU	WOOD
IT	PALA PER PIZZA		
ES	ESPÁTULA PARA PIZZA		

- Mit Holzstiel
- With wooden handle

#			
200640	360 x 305	560	920
200641	460 x 405	860	1320



DE	PIZZASCHAUFEL	
EN	PIZZA PEEL	ALU
IT	PALA PER PIZZA	
ES	ESPÁTULA PARA PIZZA	

- Mit Aluminiumstiel
- With aluminium handle

#			
200642	280 x 230	630	910
200643	355 x 305	970	1325



DE	PIZZASCHAUFEL	
EN	PIZZA PEEL	ALU
IT	PALA PER PIZZA	
ES	ESPÁTULA PARA PIZZA	

- Mit Aluminiumstiel
- With aluminium handle

#			
200647	235 x 180	250	485



DE	PIZZASCHAUFEL		
EN	PIZZA PEEL	ALU	
IT	PALA PER PIZZA		
ES	ESPÁTULA PARA PIZZA		

- Selbstmontage
- Self-assembly
- Mit schwarzem Aluminiumstiel
- With black aluminium handle

#				
200650	370 x 360	1100	1485	✓
200651	370 x 360	1500	1885	✓
200652	425 x 400	1100	1525	✓
200653	425 x 400	1500	1925	✓
200660	385 x 360	1100	1485	-
200661	385 x 360	1500	1885	-
200662	425 x 400	1100	1525	-
200663	425 x 400	1500	1925	-





DE	PIZZABLECHE	
EN	PIZZA TRAYS	
IT	TEGLIE PER PIZZA IN FERRO BLU	
ES	BANDEJAS PARA PIZZA DE HIERRO AZUL	

Material: Blaublech

- Nach Benutzung mit Küchenpapier ausreiben, gut abtrocknen, dann innen und außen mit Speiseöl einreiben
- Vor Erstgebrauch bei ca. 200°C 10 min. einbrennen und einölen
- Temperaturbeständig bis + 400°C

Made of blue steel

- After use clean with kitchen paper, dry well, then wipe with cooking oil inside and outside
- Before first use: bake at approx. 200°C for 10 min. and then oil
- Heat resistant up to + 400°C

**Materialstärke: 0,8 mm**

**Thickness: 0.8 mm**

#	↑ Ø mm	↓ Ø mm	↑ mm
997140	140	125	25
997160	160	145	25
997180	180	165	25
997200	200	180	25
997220	220	200	25
997240	240	220	25
997260	260	240	25
997280	280	260	25
997300	300	280	25
997320	320	300	25
997360	360	340	25
997400	400	380	25
997450	450	425	35
997500	500	475	35

**Materialstärke: 0,8 mm**

**Thickness: 0.8 mm**

#	→ mm	↗ mm	↑ mm
997900	400	600	25
997901	340	450	25
997902	350	500	25
997903	300	400	25
997904	325	530	25

GN  
1/1



DE	PIZZABLECHE	
EN	PIZZA MOULDS	
IT	TEGLIE PER PIZZA IN ALLUMINIO	
ES	MOLDES Y BANDEJAS PARA PIZZA DE ALUMINIO	

Material: Aluminium

- Lochung: 3 mm

Made of aluminium

- Perforation: 3 mm

#	↑ Ø mm	↓ Ø mm	↑ mm
997630	180	160	25
997631	200	180	25
997632	220	200	25
997633	240	220	25
997634	260	240	25
997635	280	260	25
997636	300	280	25
997637	320	300	25
997638	340	320	25
997639	360	340	25
997640	400	385	25
997660	380	360	25
997641	420	400	25
997642	520	500	25



DE	PIZZAGITTER / PIZZA-SCREEN	
EN	PIZZA SCREENS	
IT	RETINE PER PIZZA	
ES	REJAS PARA PIZZA	

Material: Aluminium

Made of aluminium

#	Ø mm	⊞ mm
997620	250	6
997621	280	6
997622	300	6
997623	330	6
997624	355	6
997625	405	6



DE	STÄNDER FÜR KUCHEN- UND PIZZABLECHE
EN	SUPPORT FOR CAKE- AND PIZZA MOLDS
IT	SUPPORTO PER TEGLIE PIZZA E TORTIERE
ES	SOPORTE PARA MOLDES DE PIZZA Y PASTELERIA

Material: Edelstahl

- 14 Auflagen von Blechen und Pfannen
- Auflage: 210 x 240 mm
- Abstand: 40 mm
- **Auch zur Wandmontage geeignet**

Made of stainless steel

- 14 shelves
- Shelf dimension: 210 x 240 mm
- Distance: 40 mm
- **Also suitable for wall mounting**

#	↔ mm
154813	310 x 330 x 770





DE	PIZZATEIG-DOCKER
EN	PIZZA DOUGH DOCKERS
IT	RULLI BUCASFOGLIA
ES	RODILLOS PARA PINCHAR HOJALDRE

Material: Edelstahl / Aluminium  
 • Mit ergonomischem Kunststoffgriff

Made of stainless steel / aluminium  
 • With ergonomic plastic handle

#	→ mm
154104	120 mm

Material: Kunststoff (POM), elfenbein  
 • Mit verstärktem Kunststoffgriff

Made of plastic (POM), ivory  
 • With reinforced plastic handle

#	→ mm
<input checked="" type="checkbox"/> 200001	65
<input checked="" type="checkbox"/> 200002	120

Material: Kunststoff (POM), elfenbein  
 • Ergonomischer Griff  
 • Halterung aus Metall

Made of plastic (POM), ivory  
 • Ergonomic handle  
 • Mounting made of metal

#	→ mm
200182	270

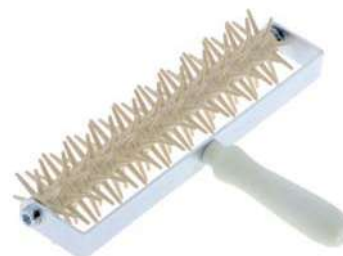

DE	HANDSCHIESSER
EN	OVEN PEELS
IT	PALE PER FORNO
ES	PALAS PARA HORNEAR



Material: Buchenholz  
 Made of beech wood

#	↗ mm	→ mm
203411	500	120
203412	500	140
203413	500	160
203414	500	180
203415	950	180
203416	950	200
203417*	1150	180
203418*	1150	200



DE	AUSKÜHLPLATTEN FÜR PIZZA / FLAMMKUCHEN
EN	COOLING PLATES FOR PIZZA
IT	PIASTRE DI RAFFREDDAMENTO PER PIZZA
ES	PLACAS DE ENFRIAMIENTO DE PIZZA



Material: Edelstahl 18/10  
 • Praktisches Display mit Luftlöchern zum Auskühlen

Made of stainless steel  
 • Practical display with air holes for cooling hot pizza

#	Ø mm	↑ mm
159700	320	50
159701	320	100
159702	320	150



# TOP-BOX PIZZA

- Speziell für heiße Pizzen
- Auch geeignet für frische Lebensmittel, Getränke, Kuchen
- Inklusive Deckel
- Ergonomisches Griffdesign
- Especially for hot pizzas
- Also suitable for fresh food, drinks, cakes
- Including lid
- Ergonomic handle design



\* mit Noppen für bessere Luftzirkulation /  
\* with knobs for improved air circulation

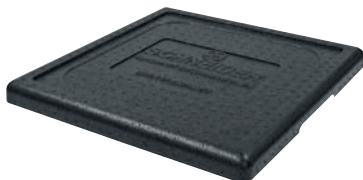

DE	TRANSPORTBOX TOP PIZZA
EN	TRANSPORT BOX TOP PIZZA
IT	TRANSPORTINO TOP PIZZA
ES	CAJA DE TRANSPORTE TOP PIZZA

#	←→ mm	⏏ mm	♻ l
650165	410 x 410 x 165	350 x 350 x 100	12,0
650240	410 x 410 x 240	350 x 350 x 175	21,0
650330 *	410 x 410 x 330	350 x 350 x 265	32,0
650395	410 x 410 x 395	350 x 350 x 330	40,0

DE	ERSATZDECKEL	
EN	SPARE LID	EPP PIZZA S
IT	COPERCHIO DI RICAMBIO	
ES	TAPA DE RECAMBIO	

- Passend für alle TOP PIZZA S
- Suitable for all TOP PIZZA S

#	←→ mm
650990	410 x 410 x 35





DE	TRANSPORTBOX TOP PIZZA
EN	TRANSPORT BOX TOP PIZZA
IT	TRANSPORTINO TOP PIZZA
ES	CAJA DE TRANSPORTE TOP PIZZA

#	↔ mm	↑ mm	∩ l
651165	480 x 480 x 182	420 x 420 x 117	21,0
651260 *	480 x 480 x 265	420 x 420 x 200	35,0



DE	ERSATZDECKEL	EPP	PIZZA	L
EN	SPARE LID			
IT	COPERCHIO DI RICAMBIO			
ES	TAPA DE RECAMBIO			

- Passend für alle TOP PIZZA L
- Suitable for all TOP PIZZA L

#	↔ mm
651990	480 x 480 x 35

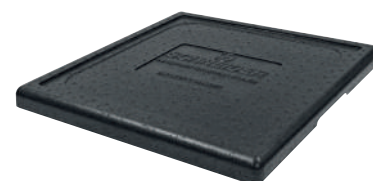

DE	TRANSPORTBOX TOP PIZZA
EN	TRANSPORT BOX TOP PIZZA
IT	TRANSPORTINO TOP PIZZA
ES	CAJA DE TRANSPORTE TOP PIZZA

#	↔ mm	↑ mm	∩ l
652280	595 x 595 x 182	535 x 535 x 115	33,0



DE	ERSATZDECKEL	EPP	PIZZA	XL
EN	SPARE LID			
IT	COPERCHIO DI RICAMBIO			
ES	TAPA DE RECAMBIO			

- Passend für TOP PIZZA XL
- Suitable for TOP PIZZA XL

#	↔ mm
652990	595 x 595 x 35



DE	TRANSPORTHILFE	ALU	PIZZA	S
EN	TRANSPORT ASSISTANCE			
IT	AIUTO AL TRASPORTO			
ES	AIUTO AL TRASPORTO			

- Passend für # 650240, 650330, 650395
- Geeignet für Pizza & Torte
- Mit Bodenlochung: 3 mm
- Suitable for # 650240, 650330, 650395
- Suitable for pizza & cake
- With perforated base: 3 mm

#	↗ mm	→ mm	↑ mm
690030	340	340	150



- Klingen aus erstklassigem Chrom-Molybdän-Stahl, Messerhärte 52 HRC.
- ergonomische Schalen-Griffe (POM) mit 2 oder 3 Edelstahlnieten

- raw blades made of first class chrome-molybdenum steel, knife hardness 52 HRC.
- ergonomically shaped handles made of POM with 2 or 3 stainless steel rivets



DE	BÄCKERMESSER
EN	BAKER'S KNIVES
IT	COLTELLI PASTICCERIA
ES	CUCHILLOS PARA PASTELERÍA



#		↗ mm*	→ mm*	
<input checked="" type="checkbox"/>	264036	glatte Schneide / straight edge	360	33
<input checked="" type="checkbox"/>	264131	feine Säge / fine saw edge	310	33
<input checked="" type="checkbox"/>	264136	feine Säge / fine saw edge	360	33
<input checked="" type="checkbox"/>	264226	Welle / wave	260	33
<input checked="" type="checkbox"/>	264231	Welle / wave	310	33
<input checked="" type="checkbox"/>	264236	Welle / wave	360	33

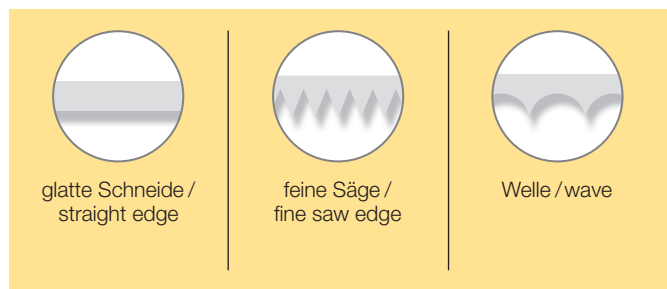

↗ mm\*: Klingenlänge / blade length → mm\*: Klingebreite / blade width

DE	KUCHENBLECHMESSER
EN	CAKE KNIFE
IT	COLTELLI DA TORTA E PASTICCERIA
ES	CUCHILLOS PARA TARTA Y PASTELERÍA

#		↗ mm*	→ mm*
<input checked="" type="checkbox"/> 264931	Welle / wave	310	33



DE	UNIVERSALMESSER
EN	UNIVERSAL KNIFE
IT	COLTELLI UNIVERSALE
ES	CUCHILLOS UNIVERSÁL

#		↗ mm*
<input checked="" type="checkbox"/> 265326	Welle / wave	260



DE	KONDITORMESSER
EN	CONFECTIONER'S KNIVES
IT	COLTELLI DA TORTA E PASTICCERIA
ES	CUCHILLOS PARA TARTA Y PASTELERÍA

#		↗ mm*	→ mm*
<input checked="" type="checkbox"/> 265426	glatte Schneide / straight edge	260	24
<input checked="" type="checkbox"/> 265431	glatte Schneide / straight edge	310	24
<input checked="" type="checkbox"/> 265526	feine Säge / fine saw edge	260	24
<input checked="" type="checkbox"/> 265531	feine Säge / fine saw edge	310	24
<input checked="" type="checkbox"/> 265536	feine Säge / fine saw edge	360	24
<input checked="" type="checkbox"/> 265626	Welle / wave	260	24
<input checked="" type="checkbox"/> 265631	Welle / wave	310	24
<input checked="" type="checkbox"/> 265636	Welle / wave	360	24



DE	KÜCHENMESSER
EN	KITCHEN KNIFE
IT	COLTELLO DA CUCINA
ES	CUCHILLO DE COCINA

#		↗ mm*
<input checked="" type="checkbox"/> 265826	Welle / wave	260



DE	WELLEN-BROTMESSER
EN	BREAD KNIFE
IT	COLTELLI DA PANE
ES	CUCHILLOS PARA PAN



#		↗ mm*	
<input checked="" type="checkbox"/> 265921	Welle / wave	210	
<input checked="" type="checkbox"/> 265926	Welle / wave	260	

DE	PALETTE MIT WELLENSCHLIFF
EN	PALETTE KNIFE WITH SCALLOPED EDGE
IT	SPATOLA SMUSSATA A LAMA SMERLATA
ES	ESPÁTULA SIN FILO



#		↗ mm*	→ mm*	
<input checked="" type="checkbox"/> 262640	Welle / wave	310	34	

DE	KUCHENBLECHMESSER
EN	CAKE KNIVES
IT	COLTELLI DA TORTA E PASTICCERIA
ES	CUCHILLOS PARA TARTA Y PASTELERÍA









#		↗ mm*	
<input checked="" type="checkbox"/> 262518	Welle / wave	180	
<input checked="" type="checkbox"/> 262522	Welle / wave	220	

DE	TORTENMESSER
EN	PIE KNIVES
IT	COLTELLI DA TORTA
ES	CUCHILLOS PARA TARTA



#		↗ mm*	
<input checked="" type="checkbox"/> 262600	glatte Schneide, feine Säge / straight edge, fine saw edge	160	
<input checked="" type="checkbox"/> 262601	Wellenschliff, glatte Schneide / wavy edge, straight edge	160	
<input checked="" type="checkbox"/> 262602	Wellenschliff, feine Säge / wavy edge, fine saw edge	160	

					
glatte Schneide / straight edge	feine Säge / fine saw edge	Welle / wave	feine Säge, glatte Schneide / fine saw edge and straight edge	Wellenschliff, glatte Schneide / wavy edge and straight edge	Wellenschliff, feine Säge / wavy edge and fine saw edge

↗ mm\*: Klingenlänge / blade length → mm\*: Klingenbreite / blade width

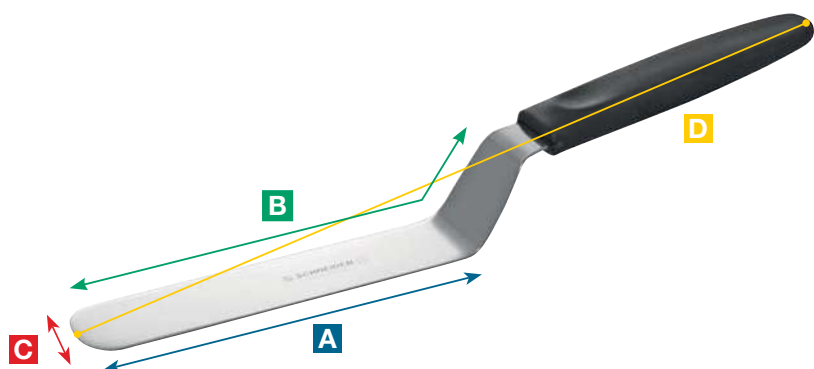

- A** Streichfläche / working surface
- B** Länge der Klinge / length of blade
- C** Breite der Klinge / width of blade
- D** Gesamtlänge / total length

DE	BACK- UND GLASURPALETTEN
EN	PALETTE KNIVES
IT	SPATOLE SMUSSATE
ES	ESPÁTULAS SIN FILO

#	A (mm)	C (mm)	D (mm)
<input checked="" type="checkbox"/> 262612	120	18	230
<input checked="" type="checkbox"/> 262616	160	34	290
<input checked="" type="checkbox"/> 262621	210	34	345
<input checked="" type="checkbox"/> 262626	260	34	385
<input checked="" type="checkbox"/> 262631	310	34	445
<input checked="" type="checkbox"/> 262636	360	34	485



DE	TORTENRINGPALETTE
EN	TARTRING SPATULA
IT	SPATOLA PER ANELLO DA TORTA
ES	ESPÁTULA PARA ARO DE TARTAS

#	A (mm)	B (mm)	C (mm)	D (mm)
<input checked="" type="checkbox"/> 262825	180	250	34	335



DE	WINKELPALETTEN
EN	ANGULAR SPATULAS
IT	SPATOLE ANGOLARI
ES	ESPÁTULAS CURVADAS

#	A (mm)	B (mm)	C (mm)	D (mm)
<input checked="" type="checkbox"/> 262712	90	150	18	230
<input checked="" type="checkbox"/> 262721	180	210	34	345
<input checked="" type="checkbox"/> 262726	230	260	34	405
<input checked="" type="checkbox"/> 262731	280	310	34	455
<input checked="" type="checkbox"/> 262736	325	360	34	500



Aluminium				
227214	175	230	35	310

# 227214

- ▶ Klinsen aus erstklassigem Chrom-Molybdän-Stahl, Vakuum-gehärtet, lange Schnitthaltigkeit.
- ▶ ergonomischer und rutschsicherer Griff aus Kunststoff.

- ▶ raw blades made of first class chrome-molybdenum steel, vacuum hardened, grinding in two steps.
- ▶ ergonomically shaped and slip-proof handle made of plastic.



DE	KONDITIONMESSER
EN	CONFECTIONER'S KNIVES
IT	COLTELLI PER PASTICCIERE
ES	CUCHILLOS PARA PASTELERO



#		↗ mm*	
<input checked="" type="checkbox"/> 260630	glatte Schneide / straight edge	300	
<input checked="" type="checkbox"/> 260631	feine Säge / fine saw edge	300	
<input checked="" type="checkbox"/> 260632	Wellenschliff / wavy edge	300	
<input checked="" type="checkbox"/> 260640	glatte Schneide / straight edge	360	
<input checked="" type="checkbox"/> 260641	feine Säge / fine saw edge	360	
<input checked="" type="checkbox"/> 260642	Wellenschliff / wavy edge	360	

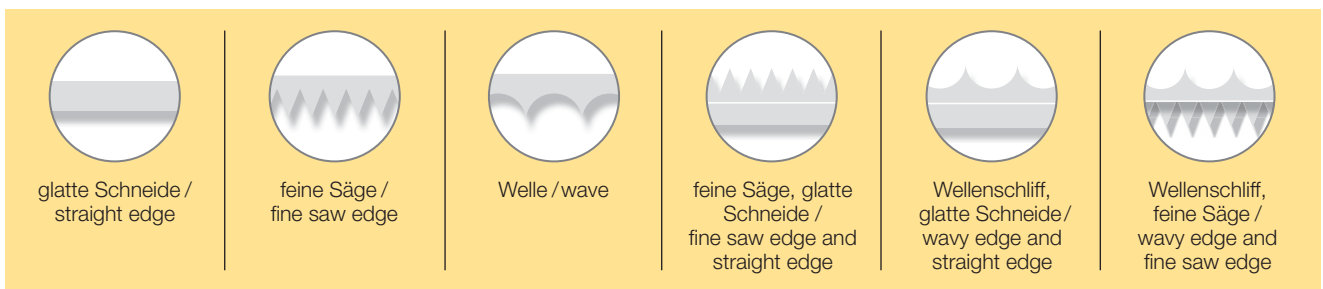

↗ mm\*: Klingenlänge / blade length → mm\*: Klingebreite / blade width

DE	BÄCKERMESSER
EN	BAKER'S KNIVES
IT	COLTELLI PER PANETTIERE
ES	CUCHILLOS PARA PANADERIA

#		↗ mm*	
<input checked="" type="checkbox"/> 260561	Welle / wave	250	
<input checked="" type="checkbox"/> 260571	Welle / wave	310	



DE	TORTENMESSER
EN	PIE KNIVES
IT	COLTELLI PER TORTE
ES	CUCHILLOS PARA TARTA

#		↗ mm*	
<input checked="" type="checkbox"/> 260610	feine Säge, glatte Schneide / fine saw edge, straight edge	160	
<input checked="" type="checkbox"/> 260611	glatte Schneide, Wellenschliff / straight edge, wavy edge	160	
<input checked="" type="checkbox"/> 260612	feine Säge, Wellenschliff / fine saw edge, wavy edge	160	



DE	KUCHEN- UND KÜCHENMESSER
EN	CAKE AND PASTRY KNIVES
IT	COLTELLI PER TORTE E PASTICCERIA
ES	CUCHILLOS PARA TARTA Y PASTELERÍA

#		↗ mm*	
<input checked="" type="checkbox"/> 260650	glatte Schneide / straight edge	310	
<input checked="" type="checkbox"/> 260651	feine Säge / fine saw edge	310	
<input checked="" type="checkbox"/> 260652	Welle / wave	310	



DE	BACKBLECHMESSER, ABGEWINKELT
EN	ANGULAR KNIVES, WAVY EDGE
IT	COLTELLI ANGOLATI PER TEGLIE
ES	CUCHILLOS ANGULADOS PARA BANDEJA DE HORNO

#		↗ mm*	
<input checked="" type="checkbox"/> 260730	Welle / wave	200	



DE	BROTMESSER
EN	BREAD KNIVES
IT	COLTELLI DA PANE
ES	CUCHILLOS PARA PAN



#		↗ mm*	
<input checked="" type="checkbox"/> 260582	Welle / wave	210	
<input checked="" type="checkbox"/> 260592	Welle / wave	240	
<input checked="" type="checkbox"/> 260600	Welle – Brotmesser spezial, abgewinkelter Griff / wave – Bread knife special, angled handle	180	



DE	BROT- UND AUFSCHNITTMESSER MIT ABSTANDSHALTER
EN	BREAD AND SLICING KNIVES WITH SPACER
IT	COLTELLI DA PANE CON DISTANZIATORE
ES	CUCHILLOS PARA PAN CON GUÍA DE CORTE



#		↗ mm*	
<input checked="" type="checkbox"/> 260740	Welle / wave	210	
<input checked="" type="checkbox"/> 260742	Welle, abgerundete Klinge / wave, rounded blade	250	



↗ mm\*: Klingenlänge / blade length → mm\*: Klingenbreite / blade width



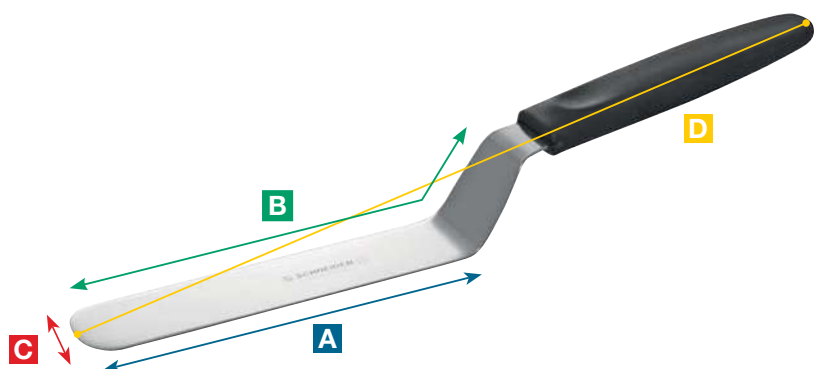

- A** Streichfläche / working surface
- B** Länge der Klinge / length of blade
- C** Breite der Klinge / width of blade
- D** Gesamtlänge / total length

DE	BACK- UND GLASURPALETTEN
EN	PALETTE KNIVES
IT	SPATOLE SMUSSATE
ES	ESPÁTULAS SIN FILO

#	A (mm)	C (mm)	D (mm)
<input checked="" type="checkbox"/> 260035	115 – "MINI"	20	220
<input checked="" type="checkbox"/> 260030	160	34	295
<input checked="" type="checkbox"/> 260031	210	34	350
<input checked="" type="checkbox"/> 260032	260	34	395
<input checked="" type="checkbox"/> 260033	310	34	435
<input checked="" type="checkbox"/> 260034	360	34	495



DE	WINKELPALETTEN – 60°
EN	ANGULAR SPATULAS – 60°
IT	SPATOLE ANGOLARI – 60°
ES	ESPÁTULAS CURVADAS – 60°

#	A (mm)	B (mm)	C (mm)	D (mm)
<input checked="" type="checkbox"/> 260044	90	115	20	220
<input checked="" type="checkbox"/> 260040	110	160	34	280
<input checked="" type="checkbox"/> 260041	160	210	34	330
<input checked="" type="checkbox"/> 260042	210	260	34	375
<input checked="" type="checkbox"/> 260043	250	310	34	415



DE	TORTENRINGPALETTE – 90°
EN	TARTRING SPATULA – 90°
IT	SPATOLA PER ANELLO DA TORTA – 90°
ES	ESPÁTULA PARA ARO DE TARTAS – 90°

#	A (mm)	B (mm)	C (mm)	D (mm)
<input checked="" type="checkbox"/> 260050	185	260	34	350



DE	WINKELPALETTEN
EN	ANGULAR SPATULAS
IT	SPATOLE ANGOLARI
ES	ESPÁTULAS CURVADAS



#	A (mm)	B (mm)	C (mm)	D (mm)
266055	90	160	34	245



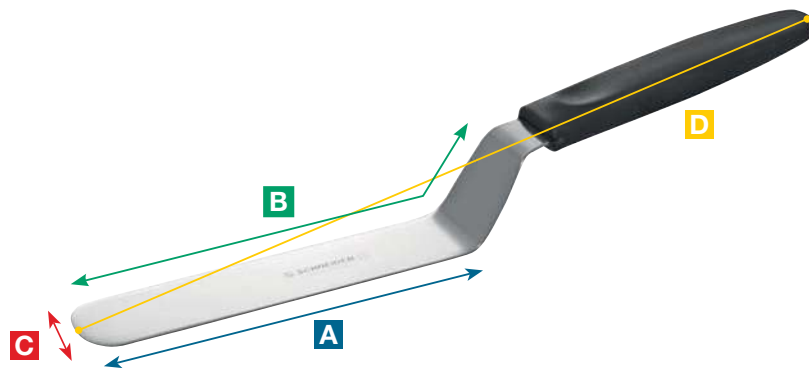

- A** Streichfläche / working surface
- B** Länge der Klinge / length of blade
- C** Breite der Klinge / width of blade
- D** Gesamtlänge / total length



DE	KUCHENPALETTEN – 60°
EN	CAKE SPATULAS – 60°
IT	SPATOLE PER DOLCI – 60°
ES	ESPÁTULAS PARA PASTELES – 60°

#	A (mm)	B (mm)	C (mm)	D (mm)
<input checked="" type="checkbox"/> 260020	100	150	45 – 50	255
<input checked="" type="checkbox"/> 260021	100	150	45 – 50	255



DE	PFANNENWENDER
EN	PAN FLIPPERS
IT	SPATOLE PER HAMBURGER
ES	ESPÁTULAS HAMBURGUESA

#	A (mm)	B (mm)	C (mm)	D (mm)
<input checked="" type="checkbox"/> 260022	200	260	85	375
<input checked="" type="checkbox"/> 260023	200	260	75	380
<input checked="" type="checkbox"/> 260024	120	170	85	290
<input checked="" type="checkbox"/> 260025	230	285	75	400



DE	PIZZAWENDER – 60°
EN	PIZZA FLIPPER – 60°
IT	SPATOLA PER PIZZA – 60°
ES	ESPÁTULA PIZZA – 60°

#	A (mm)	B (mm)	C (mm)	D (mm)
<input checked="" type="checkbox"/> 260000	115	155	90	270



DE	PFANNENWENDER – 60°
EN	PAN FLIPPER – 60°
IT	SPATOLA HAMBURGER – 60°
ES	ESPÁTULA HAMBURGUESA – 60°

#	A (mm)	B (mm)	C (mm)	D (mm)
<input checked="" type="checkbox"/> 260010	185	240	80	355

DE	BRÖTCHENMESSER / KÜCHENMESSER
EN	ROLL KNIVES
IT	COLTELLINI PER PANINI
ES	CUCHILLOS PARA BOLLITOS DE PAN

- |   |  |
|---|--|
| <ul style="list-style-type: none"> <li>• Klinge: Bandstahl</li> <li>• Wellenschliff</li> <li>• Gesamtlänge: 185 mm</li> <li>• Klingenlänge: 87 mm</li> <li>• Mit Klingenschutz</li> </ul> | <ul style="list-style-type: none"> <li>• Blade: hoop steel</li> <li>• Wave edge</li> <li>• Total length: 185 mm</li> <li>• Blade length: 87 mm</li> <li>• With blade protection</li> </ul> |
|---|--|

#		
260960	● Schwarz / black	
260961	● Orange / orange	
260962	● Rot / red	
260963	● Blau / blue	
260964	● Grün / green	
260965	● Gelb / yellow	



DE	STREICH- UND BUTTERMESSER
EN	SPREADING AND BUTTERING KNIFE
IT	SPALMINI
ES	ESPÁTULAS OVALADAS

#		↗ mm
<input checked="" type="checkbox"/> 260670		90
<input checked="" type="checkbox"/> 260671		120



DE	STREICH- UND BUTTERMESSER MIT WELLENSCHLIFF
EN	SPREADING AND BUTTERING KNIFE WITH WAVY EDGE
IT	SPALMINI
ES	ESPÁTULAS OVALADAS

#		↗ mm
<input checked="" type="checkbox"/> 260672		90
<input checked="" type="checkbox"/> 260673		120



DE	BÄCKER-KLINGE
EN	BAKER BLADE
IT	LAMETTE PER PANETTIERE
ES	CUCHILLAS DEL PANADERO

- |   |  |
|---|--|
| Klinge: Edelstahl<br><ul style="list-style-type: none"> <li>• Griff und Schutzhülle aus Kunststoff</li> </ul> | Blade made of stainless steel<br><ul style="list-style-type: none"> <li>• Handle and protection cover made of plastic</li> </ul> |
|---|--|

#		↔ mm
260890		125





DE	BREZEL-SCHNEIDE-SET
EN	PRETZEL CUTTING DEVICE SET INCLUDING KNIFE
IT	SET TAGLIA BREZEL, COLTELLO INCLUSO
ES	DISPOSITIVO DE CORTE CON CUCHILLO PARA PRETZEL

- |  |  |
|--|--|
| Material: Edelstahl mit Schnittführung     | Made of stainless steel                    |
| • Kunststoffscharnier                      | • Plastic hinge                            |
| • Zum praktischen Aufschneiden von Brezeln | • With guide for quick slicing of pretzels |
| • Inkl. Messer (200 mm)                    | • Including knife (200 mm)                 |

#	↔ mm
154810	195 x 130



DE	THEKEN-DISPLAY „VESPERMESSER“
EN	COUNTER DISPLAY „ALLROUND UTILITY KNIFE“
IT	ESPOSITORE DA BANCO DI COLTELLI
ES	EXPOSITOR DE CUCHILLOS

- |  |   |
|--|---|
| Vespermesser mit Kunststoffgriff,<br>Micro Schliff | Allround utility knife with plastic handle,<br>micro ground |
| • Rostfreier Stahl                                 | • Stainless steel   |
| • 20 Stück pro Display                             | • 20 pieces per display                                     |



#	Inhalt / content
261800	12 x schwarz , 8 x rot / 12 x black, 8 x red



DE	THEKEN-DISPLAY „FRÜHSTÜCKSMESSER“
EN	COUNTER DISPLAY „BREAKFAST KNIFE“
IT	ESPOSITORE DA BANCO DI COLTELLI DA COLAZIONE
ES	EXPOSITOR DE CUCHILLOS DE DESAYUNO

- |  |   |
|--|---|
| Frühstücksmesser mit Kunststoffgriff,<br>Micro Schliff | Allround utility knife with plastic handle,<br>micro ground |
| • Rostfreier Stahl                                     | • Stainless steel   |
| • 30 Stück pro Display                                 | • 30 pieces per display                                     |



#	Inhalt / content
261810	10 x schwarz , rot, blau / 10 x black, red, blue

**Pflegehinweis:**

Alle Messer und Paletten sind grundsätzlich spülmaschinengeeignet. Die Reinigung in der Spülmaschine ist durch die heute zum Einsatz kommenden Reinigungsmittel jedoch wesentlich aggressiver als die Reinigung von Hand.

Speisemittelreste wie Obstsäuren, hochkonzentriertes Reinigungsmittel oder langes Verbleiben der Messer im heißen Dampf kann auf den Klingen zu Flecken bzw. im schlimmsten Fall zu Rostbildung führen.

Gleichzeitig führen starke chemische Reinigungsmittel zu einem elektrochemischen Abbau der Schneide.

Daher empfehlen wir die Reinigung sofort nach Gebrauch per Hand unter fließendem Wasser mit einem sanften Lappen und einem milden Reinigungsmittel.

Durch ein anschließend sorgfältiges trocken wischen der Messer mit einem weichen Tuch nach dem Reinigen, werden Flecken auf der Klinge vermieden. Außerdem wird die Schneide geschont und bleibt länger scharf.

**Instructions for care**

All knives and cake spatulas are in general dishwasher safe. Cleaning by hand is recommended, thus you prevent that the blade gets in contact with aggressive detergents.

Food remnants such as ascorbic acids, highly concentrated detergents, or prolonged exposure to hot water steam, may cause the blade to stain, or even develop rust, in the worst case.

Strong chemical cleaning agents will at the same time lead to the electrochemical deterioration of the cutting edge.

Right away after each use, we therefore recommend rinsing under running water, using a soft cloth and mild detergent.

Wiping the knife with a soft cloth after cleaning will prevent the blade from developing stains. This will conserve the cutting edge which means it will remain sharper much longer.



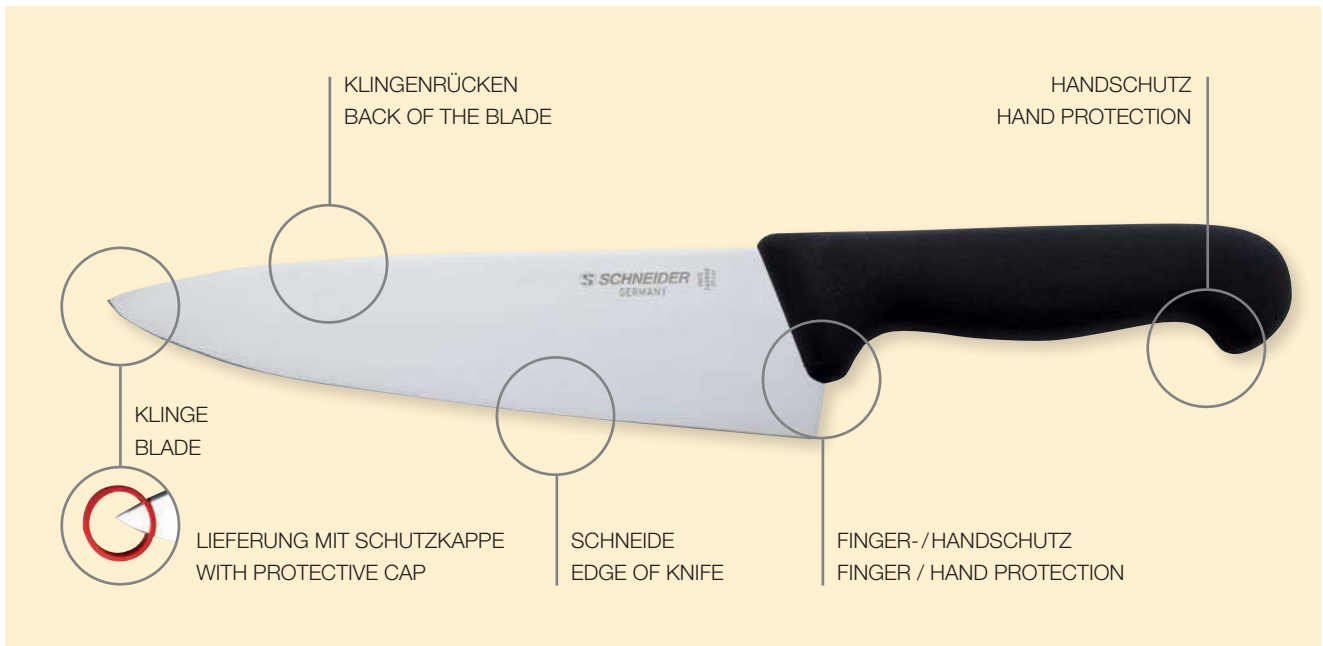

DE	KOCHMESSER – BREITE KLINGE
EN	CHEF'S KNIVES – WIDE BLADE
IT	COLTELLI DA CUCINA – LAMA LARGA
ES	CUCHILLOS DE COCINA DE HOJA ANCHA



#		↗ mm*
<input checked="" type="checkbox"/> 260800	● Schwarz / black	200
<input checked="" type="checkbox"/> 260801	● Schwarz / black	260
<input checked="" type="checkbox"/> 260802	● Schwarz / black	310
<input checked="" type="checkbox"/> 260804	● Rot / red	160
<input checked="" type="checkbox"/> 260812	● Rot / red	200
<input checked="" type="checkbox"/> 260805	● Blau / blue	160
<input checked="" type="checkbox"/> 260813	● Blau / blue	200
<input checked="" type="checkbox"/> 260806	● Grün / green	160
<input checked="" type="checkbox"/> 260814	● Grün / green	200
<input checked="" type="checkbox"/> 260803	● Gelb / yellow	160
<input checked="" type="checkbox"/> 260811	● Gelb / yellow	200
<input checked="" type="checkbox"/> 260807	● Braun / brown	160
<input checked="" type="checkbox"/> 260815	● Braun / brown	200

**HACCP-KENNZEICHNUNG Verwendungsgebiet / HACCP-MARKING Area of use:**

- |                   |                          |                 |   |
|-------------------|--------------------------|-----------------|---|
| ● Schwarz / black | allgemein / general      | ● Grün / green  | Obst und Gemüse / fruits and vegetables |
| ● Rot / red       | Rohes Fleisch / raw meat | ● Gelb / yellow | Geflügel / poultry meat                 |
| ● Blau / blue     | Fisch / fish             | ● Braun / brown | gekochte Lebensmittel / cooked food     |

↗ mm\*: Klingenlänge / blade length

DE	KOCHMESSER – SCHMALE KLINGE
EN	CHEF'S KNIVES – NARROW BLADE
IT	COLTELLI DA CUCINA – LAMA STRETTA
ES	CUCHILLOS DE COCINA DE HOJA ESTRECHA

#		↗ mm*	
<input checked="" type="checkbox"/> 260830	● Schwarz / black	160	
<input checked="" type="checkbox"/> 260831	● Schwarz / black	180	
<input checked="" type="checkbox"/> 260832	● Schwarz / black	200	
<input checked="" type="checkbox"/> 260833	● Rot / red	160	
<input checked="" type="checkbox"/> 260834	● Rot / red	180	
<input checked="" type="checkbox"/> 260835	● Rot / red	200	
<input checked="" type="checkbox"/> 260836	● Blau / blue	160	
<input checked="" type="checkbox"/> 260837	● Blau / blue	180	
<input checked="" type="checkbox"/> 260838	● Blau / blue	200	
<input checked="" type="checkbox"/> 260839	● Grün / green	160	
<input checked="" type="checkbox"/> 260840	● Grün / green	180	
<input checked="" type="checkbox"/> 260841	● Grün / green	200	



DE	SANTOKU
EN	SANTOKU
IT	SANTOKU
ES	SANTOKU

#			↗ mm*	
<input checked="" type="checkbox"/> 260660	● Schwarz / black	ohne Kulle	180	
<input checked="" type="checkbox"/> 260661	● Schwarz / black	mit Kullenschliff / with scalloped edge	180	



DE	KEBAB-MESSER
EN	KEBAB KNIVES
IT	COLTELLI KEBAB
ES	CUCHILLOS PARA KEBAB

#		↗ mm*	→ mm*	
<input checked="" type="checkbox"/> 260350	glatte Schneide, harte Klinge/ straight edge, hard blade	500	33	
<input checked="" type="checkbox"/> 260360	glatte Schneide, flexible Klinge/ straight edge, flexible blade	550	33	



DE	GYROS-MESSER
EN	GYROS KNIFE
IT	COLTELLI GYROS
ES	CUCHILLOS PARA GYROS

#		↗ mm*	→ mm*	
<input checked="" type="checkbox"/> 260370	Welle / wave	360	33	



**GLATTER SCHLIFF:** Schneider bietet Ihnen den perfekten Klingenschliff für jeden Einsatzbereich und jede Anforderung. Wählen Sie aus einer Vielzahl von Klingenformen- und -längen.

**PLAIN EDGE:** Schneider provides perfect blades for all types of applications and requirements. Take your pick from a variety of blade shapes and lengths.



**GEZAHNTER SCHLIFF:** Zum Schneiden von Obst und Gemüse mit Haut oder härterer Schale. Die Klinge gleitet mühelos durch die Schale, ohne das Schneidgut zu quetschen.

**SERRATED EDGE:** Suited for the cutting of fruit and vegetables with hard skin. The blade slides effortlessly through the skin without damaging the flesh.



**WELLENSCHLIFF:** Durch regelmäßige Wellen entlang der Klinge gleitet das Messer sicher und ohne abzurutschen durch Schneidgut mit harten Schalen oder Krusten.

**WAVY EDGE:** The regularly grinded waves along the cutting edge enable the knife to slide securely and without slipping through hard peels, rinds and crusts.



DE	GEMÜSEMESSER
EN	VEGETABLE KNIVES
IT	COLTELLI PER VERDURE
ES	CUCHILLOS PARA VERDURA



#		↗ mm*
<input checked="" type="checkbox"/> 260860	● Schwarz / black	100
<input checked="" type="checkbox"/> 260861	● Rot / red	100
<input checked="" type="checkbox"/> 260862	● Blau / blue	100
<input checked="" type="checkbox"/> 260863	● Grün / green	100
<input checked="" type="checkbox"/> 260864	● Gelb / yellow	100
<input checked="" type="checkbox"/> 260865	○ Weiß / white	100

DE	AUSBEINMESSER
EN	BONING KNIFE
IT	COLTELLI PER DISOSSO
ES	CUCHILLOS PARA DESHUESAR



#		↗ mm*
<input checked="" type="checkbox"/> 260876	● Rot / red	150
<input checked="" type="checkbox"/> 260877	● Blau / blue	150

DE	TOURNIERMESSER
EN	BIRD'S BEAK PEELING KNIFE
IT	COLTELLO SPELUCCHINO
ES	CUCHILLO DE PELAR



#		↗ mm*
<input checked="" type="checkbox"/> 260878	● Grün / green	60

↗ mm\*: Klingenlänge / blade length



DE	UNIVERSALMESSER – WELLENSCHLIFF
EN	UNIVERSAL KNIVES – WAVY EDGE
IT	COLTELLI UNIVERSALI
ES	CUCHILLOS UNIVERSALES

#		↗ mm*	
<input checked="" type="checkbox"/> 260700	● Schwarz / black	250	
<input checked="" type="checkbox"/> 260701	● Rot / red	250	
<input checked="" type="checkbox"/> 260702	● Blau / blue	250	
<input checked="" type="checkbox"/> 260703	● Grün / green	250	



DE	UNIVERSALMESSER / TOMATENMESSER – WELLE
EN	UNIVERSAL KNIVES – WAVE
IT	COLTELLI UNIVERSALI DENTATI
ES	CUCHILLOS UNIVERSALES DENTADOS

#		↗ mm*	
<input checked="" type="checkbox"/> 260820	● Schwarz / black	110	
<input checked="" type="checkbox"/> 260819	● Rot / red	110	
<input checked="" type="checkbox"/> 260818	● Blau / blue	110	
<input checked="" type="checkbox"/> 260817	● Grün / green	110	
<input checked="" type="checkbox"/> 260816	● Gelb / yellow	110	



DE	FILIERMESSER
EN	FILLETING KNIFE
IT	COLTELLI PER SFILETTARE
ES	CUCHILLOS PARA FILETEAR

#		↗ mm*	
<input checked="" type="checkbox"/> 260850	Schneide / plain	160	



DE	KÜCHENMESSER
EN	KITCHEN KNIFE
IT	COLTELLI DA CUCINA
ES	CUCHILLO DE COCINA

#		↗ mm*	
<input checked="" type="checkbox"/> 260810	Schneide / plain	130	



DE	AUSBEINMESSER, GERADE KLINGE
EN	BONING KNIVES, STRAIGHT BLADE
IT	COTELLO DISOSSO, LAMA DIRITTA
ES	DESHUESADOR, HOJA RECTA



#		↗ mm*
<input checked="" type="checkbox"/> 268013	● Gelb / yellow	130
<input checked="" type="checkbox"/> 268015	● Gelb / yellow	150

DE	AUSBEINMESSER, HALBFLEXIBLE KLINGE
EN	BONING KNIVES, SEMI-FLEXIBLE BLADE
IT	COTELLO DISOSSO, SEMI FLEX
ES	DESHUESADOR, SEMI FLEX



#		↗ mm*
<input checked="" type="checkbox"/> 268113	● Gelb / yellow	130
<input checked="" type="checkbox"/> 268115	● Gelb / yellow	150

DE	STECHMESSER
EN	STICKING KNIVES
IT	COLTELLO AFFETTARE
ES	CUCHILLO SANGRADO



#		↗ mm*
<input checked="" type="checkbox"/> 268213	● Gelb / yellow	130
<input checked="" type="checkbox"/> 268216	● Gelb / yellow	160
<input checked="" type="checkbox"/> 268218	● Gelb / yellow	180

DE	ZUSCHNEIDEMESSER
EN	BREAKING KNIVES
IT	COLTELLO PER TAGLIARE
ES	CUCHILLO PARA DESPIECE



#		↗ mm*
<input checked="" type="checkbox"/> 268320	● Gelb / yellow	200
<input checked="" type="checkbox"/> 268325	● Gelb / yellow	250

DE	SCHLACHTMESSER
EN	BUTCHER KNIVES
IT	COLTELLO SCIMITARRA
ES	CUCHILLO DE CARNICERO



#		↗ mm*
<input checked="" type="checkbox"/> 268421	● Gelb / yellow	210
<input checked="" type="checkbox"/> 268424	● Gelb / yellow	240

↗ mm\*: Klingenlänge / blade length

DE	UNIVERSALSCHERE
EN	KITCHEN SCISSORS
IT	FORBICI DA CUCINA
ES	TIJERAS DE COCINA

- Klinge aus rostfreiem Edelstahl
- Bruchfeste Kunststoffgriffe
- Justierbare Schraube
- Blades made of stainless steel
- Unbreakable plastic handles
- Adjustable screw

#		↗ mm
<input checked="" type="checkbox"/> 260905		71
<input checked="" type="checkbox"/> 260906	mit Aushebeln funktion / Levering mechanism	71



# 260905



Anwendungsbeispiel /  
Application example  
# 260906



# 260906

DE	ABZIEHSTAHL/WETZSTAHL
EN	SHARPENING STEELS
IT	AFFILATORI
ES	AFILADORES

#		↔ mm
<input checked="" type="checkbox"/> 260900	rund / round	250
<input checked="" type="checkbox"/> 260901	rund / round	310

#		↔ mm
<input checked="" type="checkbox"/> 260902	oval / oval	250
<input checked="" type="checkbox"/> 260903	oval / oval	310



DE	MESSER-STERILISIERUNGSGERÄT
EN	KNIFE-STERILIZER
IT	STERILIZZATORE PER COLTELLI
ES	ESTERILIZADOR DE CUCHILLOS

- Gehäuse aus Edelstahl, Türe aus Methacrylat. Anti-UV-Dispersion mit Magnetverschluss.
- Sicherheitsschalter für automatisches Ausschalten der Lampe beim Öffnen der Türe
  - Zeiteinstellung 0–60 min.
  - Für ca. 20 Messer
  - Leistung: 16 W
  - Spannung: 230 V / 50 Hz

- Stainless steel housing, methacrylate door. Anti-UV dispersion with magnetic closure.
- Safety switch for automatic switch off the lamp when opening the door
  - Timer 0–60 min.
  - For approx. 20 knives
  - Power: 16 W
  - Voltage: 230 V / 50 Hz

#	↔ mm	⚖ kg
260099	670 x 510 x 130	9





HACCP-KENNZEICHNUNG Verwendungsgebiet:	
● schwarz	Allgemein
● rot	Rohes Fleisch
● blau	Fisch
● grün	Obst und Gemüse
● gelb	Geflügel
● braun	gekochte Lebensmittel
○ weiß	Backwaren / Milchprodukte
● lila	Antiallergisch

HACCP-MARKING Area of use:	
● black	General
● red	Raw Meat
● blue	Fish
● green	Fruits and vegetables
● yellow	Poultry meat
● brown	Cooked food
○ white	Bakery and dairy products
● purple	Antiallergic

DE	SCHNEIDBRETTER	
EN	CUTTING BOARDS	
IT	TAGLIERI	
ES	TABLAS DE CORTAR	

- Material: PP
- Ohne Füße
  - Spülmaschinengeeignet
  - Geruchs- und geschmacksneutral
  - Schont die Messerklingen
  - **Materialstärke: 1,0 cm**

- Made of PP
- Without feet
  - Dishwasher safe
  - Neutral smell and taste
  - Protects the knife blades.
  - **Thickness: 1.0 cm**

#		↔ mm
228300	○ Weiß / white	450 x 300
228301	● Braun / brown	450 x 300
228302	● Grün / green	450 x 300
228303	● Rot / red	450 x 300
228304	● Gelb / yellow	450 x 300
228305	● Blau / blue	450 x 300

DE	SCHNEIDBRETTER GN 1/1	
EN	CUTTING BOARDS GN 1/1	
IT	TAGLIERI GN 1/1	
ES	TABLAS DE CORTAR GN 1/1	

- Material: HD-PE 500
- Mit Füßen
  - Spülmaschinengeeignet
  - Schwere Qualität
  - Geruchs- und geschmacksneutral
  - Schont die Messerklingen.
  - **Materialstärke: 2,0 cm**

- Made of HD-PE 500
- With feet
  - Dishwasher safe
  - Heavy quality
  - Neutral in taste and smell
  - Protects the knife blades.
  - **Thickness: 2.0 cm**

#		↔ mm
228310	○ Weiß / white	530 x 325
228311	● Braun / brown	530 x 325
228312	● Grün / green	530 x 325
228313	● Rot / red	530 x 325
228314	● Gelb / yellow	530 x 325
228315	● Blau / blue	530 x 325
228316	● Lila / purple	530 x 325

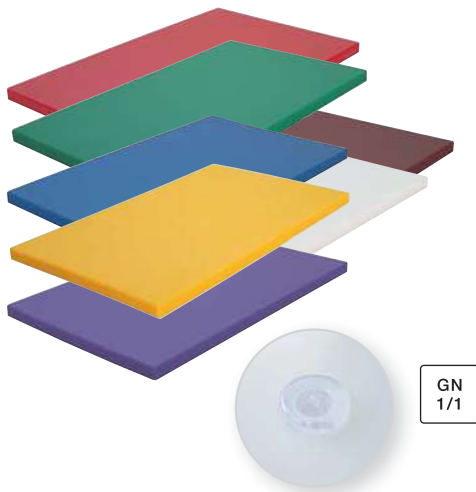

DE	SCHNEIDEBRETT-SET HACCP	
EN	CUTTING BOARD SET HACCP	
IT	SET DI TAGLIERI HACCP	
ES	JUEGO DE TABLAS DE CORTAR HACCP	

Material: HD-PE

- Die stabile Bodenplatte hält die farbigen Schneideunterlagen immer fixiert
- Austauschbar
- Schont die Messerklingen
- Schneideunterlagen: je 3 mm Stärke
- Farben: rot, gelb, grün, blau, weiß, braun

Material: HD-PE

- The stable base plate keeps the colored cutting pads always fixed
- Exchangeable
- Protects the knife blades
- Cutting pads: each 3 mm thick
- Colours: red, yellow, green, blue, white, brown



GN 1/1

#	↔ mm	↑ mm
228330	400 x 300	38
228332	400 x 600	38
228333	GN 1/1 – 530 x 325	38

DE	ERSATZ-SCHNEIDEBRETT	
EN	REPLACEMENT CUTTING BOARD	
IT	TAGLIERE DI RISERVA	
ES	TABLAS DE CORTAR DE REPUESTO	

Set á 6 Stk. je Farbe

Set of 6 pcs. per color

#		↔ mm
228350	○ Weiß / white	400 x 300
228351	● Braun / brown	400 x 300
228352	● Grün / green	400 x 300
228353	● Rot / red	400 x 300
228354	● Gelb / yellow	400 x 300
228355	● Blau / blue	400 x 300
228360	○ Weiß / white	400 x 600
228361	● Braun / brown	400 x 600
228362	● Grün / green	400 x 600
228363	● Rot / red	400 x 600
228364	● Gelb / yellow	400 x 600
228365	● Blau / blue	400 x 600
228370	○ Weiß / white	GN 1/1 – 530 x 325
228371	● Braun / brown	GN 1/1 – 530 x 325
228372	● Grün / green	GN 1/1 – 530 x 325
228373	● Rot / red	GN 1/1 – 530 x 325
228374	● Gelb / yellow	GN 1/1 – 530 x 325
228375	● Blau / blue	GN 1/1 – 530 x 325

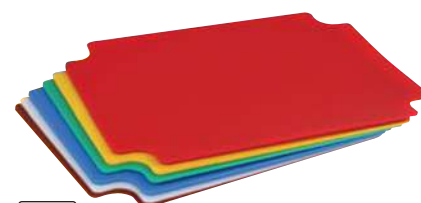

60x40

GN 1/1

DE	SCHNEIDEBRETT MIT SAFTSCHALE – SET	
EN	CUTTING BOARD WITH DRIPPING TRAY – SET	
IT	TAGLIERE CON VASSOIO DI SGOCCIOLAMENTO	
ES	TABLA DE CORTAR CON BANDEJA DE GOTEÓ	

Material: HD-PE 500, schwarz

- Auffangschale für Fleischsaft, aus Edelstahl, gezogene Ecken, 325 x 530 x 20 mm
- Mit Füßen
- Abmessungen: 295 x 495 x 20 mm

Made of HD-PE 500, black

- Collecting tray for meat juice, made of stainless steel, drawn corners, 325 x 530 x 20 mm
- With feet
- Dimension: 295 x 495 x 20 mm



GN 1/1

#	
228395	1 Set



DE	SCHNEIDEBRETTER
EN	CUTTING BOARDS
IT	TAGLIERI
ES	TABLAS DE CORTAR



- Material: HD-PE 500, weiß
- Mit Füßen
  - Umlaufender Safrinne
  - Spülmaschinengeeignet
  - Schwere Qualität
  - Geruchs- und geschmacksneutral
  - Schont die Messerklingen
  - **Materialstärke: 2,0 cm**

- Made of HD-PE 500, white
- With feet
  - Surrounding groove
  - Dishwasher safe
  - Heavy quality
  - Neutral in taste and smell
  - Protects the knife blades
  - **Thickness: 2.0 cm**

#	↔ mm
228390	400 x 250
228391	500 x 300



DE	SCHNEIDEBRETTHOBEL
EN	BOARD SCRAPER
IT	RASCHIETTO
ES	RASCADOR

Material: HD-PE, weiß

Made of HD-PE, white

#	↔ mm
228130	160 x 60
228131	Ersatzklinge / Spare blade

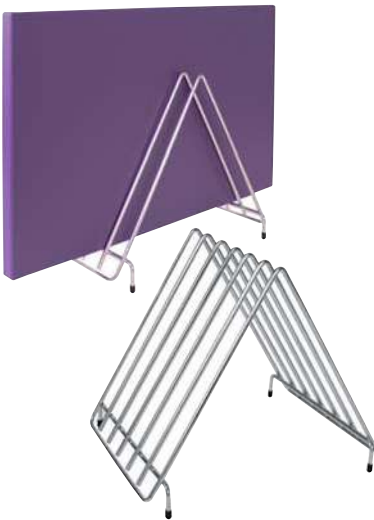

DE	ABTROPFSTÄNDER FÜR 6 SCHNEIDEBRETTER
EN	DRAINING RACK FOR 6 CUTTING BOARDS
IT	SCOLAPIATTI PER 6 TAGLIERI
ES	ESCURREPLATOS PARA 6 TABLAS DE CORTAR

Material: Chromnickelstahl, rostfrei

Made of stainless chrome-nickel steel

#	↔ mm
228340	270 x 270 x 270

DE	MAGNETLEISTE / MESSERLEISTE
EN	MAGNET BAR
IT	BARRA MAGNETICA
ES	BARRA MAGNÉTICA

- Inklusive Befestigungsmaterial

- Including fittings



#	↔ mm
260910	500

DE	MESSER-ABSTREIFBEHÄLTER – EINBAUGERÄT
EN	KNIFE CLEANER – FOR HANGING INTO COUNTERS
IT	PULISCI COLTELLI – DA INCASSO
ES	CONTENEDOR DE LIMPIEZA CUCHILLOSS – EMPOTRABLE

Material: Edelstahl

- Mit Außen- und Innenbehälter
- Der Innenbehälter wird zum Wasserwechsel herausgenommen
- Mit Schlitzdeckel
- Umlaufender Rand 10 mm
- Unbeheizt

Made of stainless steel

- With outer and inner container
- The inner container can be removed for water exchange
- With slot cover
- Circulatory edge 10 mm
- Without heating



#	↑ mm	Ø mm	↔ mm
270003	180	100	125

DE	MESSER-ABSTREIFBEHÄLTER – STANDGERÄT
EN	STANDING KNIFE CLEANER – WITH SOCKET
IT	PULISCI COLTELLI – DA BANCO
ES	CONTENEDOR DE LIMPIEZA CUCHILLOSS – PARA MESA

Material: Edelstahl

- Mit Schlitzdeckel
- Unbeheizt

Made of stainless steel

- With slot cover
- Without heating



#	↑ mm	Ø mm	↔ mm
270000	180	100	130

DE	MESSER-ABSTREIFBEHÄLTER – WANDGERÄT
EN	KNIFE CLEANER – FOR WALL-MOUNTING
IT	PULISCI COLTELLI – DA MURO
ES	CONTENEDOR DE LIMPIEZA CUCHILLOSS – PARA MURO

Material: Edelstahl

- Mit Außen- und Innenbehälter
- Der Innenbehälter wird zum Wasserwechsel herausgenommen
- Mit Schlitzdeckel
- Umlaufender Rand 10 mm
- Inklusive Wandhalterung

Made of stainless steel

- With outer and inner container
- The inner container can be removed for water exchange
- With slot cover
- Circulatory edge 10 mm
- Including wall mounting bracket

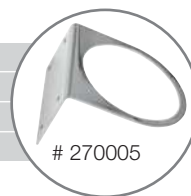

#	↑ mm	Ø mm	↔ mm
270004	180	100	135
270005	nur Halter passend für / bracket for		# 270003

#	Ersatzteile / replacement parts
270001	Abstreifgummi / Spare rubber
270002	Bodengummi / round rubber base
270006	Deckel / Lid

# 270001

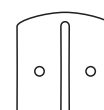

# 270006





DE THERMO-ROLLEN FÜR WAAGEN – 52 g/m<sup>2</sup>  
 EN THERMAL ROLLS FOR SCALES – 52 g/m<sup>2</sup>

#		für / for		
820419	62 mm x 50 m x 12 mm	Mettler	○ weiß / white	50
820421	62 mm x 50 m x 12 mm	Mettler	● gelb / yellow	50
820420	62 mm x 50 m x 12 mm	Mettler	● rot / red	50
820422	62 mm x 50 m x 12 mm	Mettler	● grün / green	50
820423	62 mm x 50 m x 12 mm	Mettler	● blau / blue	50
820138	62 mm x 100 m x 12 mm	Mettler	○ weiß / white	27
820134	57 mm x 40 m x 12 mm (IW)	Mettler	○ weiß / white	50
820407	58 mm x 50 m x 12 mm	Bizerba	○ weiß / white	50
820413	58 mm x 50 m x 12 mm	Bizerba	● gelb / yellow	50
820410	58 mm x 50 m x 12 mm	Bizerba	● rot / red	50
820414	58 mm x 50 m x 12 mm	Bizerba	● grün / green	50
820411	58 mm x 50 m x 12 mm	Bizerba	● blau / blue	50
820020	72 mm x 50 m x 12 mm	Bizerba	○ weiß / white	50
820268	57 mm x 50 m x 12 mm	Berkel	○ weiß / white	50
820041	60 mm x 50 m x 12 mm	Berkel	○ weiß / white	50
820241	60 mm x 100 m x 12 mm	Berkel	○ weiß / white	24
820086	51,5 mm x 100 m x 38,5 mm	Berkel	○ weiß / white	24
820001	51,5 mm x 60 m x 40 mm	TEC	○ weiß / white	45
820032	62 mm x Ø 58 mm x 12 mm	Testut	○ weiß / white	50
820404	57 mm x 25 m x 12 mm (IW)	Testut	○ weiß / white	50
820031	57 mm x 25 m x 12 mm (IW)	Testut	○ weiß / white	100
820286	58 mm x 50 m x 12 mm	DIGI	○ weiß / white	48
820121	50 mm x 200 m x 12 mm (IW)	DIGI	○ weiß / white	20
820132	60 mm x 105 m x 38,5 mm	DIGI	○ weiß / white	15
820122	42 mm x 100 m x 12 mm	YAMATO	○ weiß / white	36
820191	62 mm x Ø 58 mm x 12 mm	HELMAC	○ weiß / white	50
820181	62 mm x 50 m x 12 mm	HELMAC	○ weiß / white	50
820432	62 mm x Ø 80 mm x 17,5 mm	HELMAC	○ weiß / white	60
820033	60 mm x 25 m x 12 mm	METO	○ weiß / white	100
820037	62 mm x 25 m x 12 mm	OMEGA	○ weiß / white	100
820111	60 mm x Ø 55 mm x 12 mm	EPELSA	○ weiß / white	50
820116	58 mm x 40 m x 12 mm	GRAEF/ DATALINE	○ weiß / white	50
820298	58 mm x 45 m x 12 mm	ITALIANA MACCHI	○ weiß / white	50
820035	58 mm x 35 m x 12 mm	DIBAL	○ weiß / white	50
820141	60 mm x Ø 60 mm x 12 mm (IW)	DIBAL	○ weiß / white	50

- Andere Abmessungen, Sondergrößen oder Verpackungseinheiten auf Anfrage.
- Weitere Grammaturen (48, 70, 80 g/m<sup>2</sup>), sowie BPA- und / oder Phenolfrei sind ebenfalls lieferbar. Bitte fragen Sie gerne bei uns an!

- All current dimensions available – special sizes upon request.
- Further paper qualities (48, 70, 80 g/m<sup>2</sup>) as well as BPA free and / or phenol-free paper are also available.



DE	THERMO-ROLLEN FÜR KASSEN – 52 g/m <sup>2</sup>
EN	THERMAL ROLLS FOR CASH REGISTERS – 52g/m <sup>2</sup>



#		für / for		
820119	57 mm x 10 m x 12 mm, blanko	EC-Cash	○ weiß / white	50
821154	57 mm x 10 m x 12 mm, 0/1-farbig "Lastschrift" (SEPA)	EC-Cash	○ weiß / white	50
821165	57 mm x 12 m x 12 mm	EC-Cash	○ weiß / white	50
820187	57 mm x 12 m x 12 mm 0/1-farbig "Lastschrift" (SEPA)	EC-Cash	○ weiß / white	50
821083	57 mm x 15 m x 12 mm	EC-Cash	○ weiß / white	50
820943	57 mm x 15 m x 12 mm 0/1-farbig "Lastschrift" (SEPA)	EC-Cash	○ weiß / white	50
820335	57 mm x 18 m x 12 mm	EC-Cash	○ weiß / white	50
821459	57 mm x 18 m x 12 mm 0/1-farbig "Lastschrift" (SEPA)	EC-Cash	○ weiß / white	50
820306	57 mm x 25 m x 12 mm, blanko	EC-Cash	○ weiß / white	50
820008	57 mm x 25 m x 12 mm, 0/1-farbig "Lastschrift" (SEPA)	EC-Cash	○ weiß / white	50
820408	57 mm x 50 m x 12 mm, blanko	EC-Cash	○ weiß / white	50
820009	57 mm x 50 m x 12 mm, 0/1-farbig "Lastschrift" (SEPA)	EC-Cash	○ weiß / white	50
820154	80 mm x 80 m x 12 mm, 0/1-farbig "Lastschrift" (SEPA)	EPSON	○ weiß / white	50
820991	80 mm x 80 m x 12 mm, 0/1-farbig "Bewirtungsnachweis"	EPSON	○ weiß / white	30
820092	80 mm x 50 m x 12 mm	EPSON	○ weiß / white	50
820239	80 mm x 50 m x 12 mm (wärmebeständig)	EPSON	○ weiß / white	50
820227	80 mm x 50 m x 12 mm	EPSON	● rot / red	50
820215	80 mm x 70 m x 12 mm	EPSON	○ weiß / white	50
820416	80 mm x 80 m x 12 mm	EPSON	○ weiß / white	30
820415	80 mm x 80 m x 12 mm	EPSON	○ weiß / white	40
820097	80 mm x 80 m x 12 mm	EPSON	○ weiß / white	50
820409	57 mm x 50 m x 12 mm	SHARP	○ weiß / white	50
820153	57,5 mm x 50 m x 17,5 mm (70 gr.)	SHARP	○ weiß / white	50
820135	57 mm x Ø 80 mm x 17,5 mm	SHARP	○ weiß / white	50
820136	57 mm x 80 m x 12 mm	SHARP	○ weiß / white	50
820242	80 mm x 40 m x 12 mm	SHARP	○ weiß / white	50
820250	57,5 mm x 50 m x 17,5 mm (70 gr.)	CASIO	○ weiß / white	50
820145	60 mm x 70 m x 12 mm	CASIO	○ weiß / white	60
820049	60 mm x Ø 80 mm x 18,4 mm	CASIO	○ weiß / white	50
820120	58 mm x 35 m x 12 mm	NORIS-XT	○ weiß / white	50
820606	57 mm x 200 m x 25 mm	TOMRA	○ weiß / white	12





DE	THERMO-ROLLEN FÜR KASSEN – 52 g/m <sup>2</sup>
EN	THERMAL ROLLS FOR CASH REGISTERS – 52 g/m <sup>2</sup>

**bedruckt 0/1-farbig – “Tankstellentext, neutral”**

#			
820321	58 mm x 50 m x 12 mm	○ weiß / white	50
820320	60 mm x 50 m x 12 mm	○ weiß / white	50
820319	80 mm x 50 m x 12 mm	○ weiß / white	50
820931	80 mm x 80 m x 12 mm	○ weiß / white	40

**bedruckt 0/1-farbig – “e-loading-Text”**

820302	57,5 mm x 26 m x 12 mm	○ weiß / white	50
--------	------------------------	----------------	----

DE	KASSENROLLEN HOLZFREI – 60 g/m <sup>2</sup>
EN	CASH REGISTERS ROLLS WOODFREE – 60 g/m <sup>2</sup>



#			
830006	44 mm x Ø 70 mm x 12 mm	○ weiß / white	100
830007	44 mm x Ø 70 mm x 17,5 mm	○ weiß / white	100
830008	44 mm x Ø 80 mm x 12 mm	○ weiß / white	100
830001	44 mm x Ø 80 mm x 17,5 mm	○ weiß / white	100

830040	57 mm x Ø 50 mm x 12 mm	○ weiß / white	100
830003	57 mm x 40 m x 12 mm	○ weiß / white	100
830024	57 mm x Ø 70 mm x 12 mm	○ weiß / white	100

830025	58 mm x Ø 70 mm x 17,5 mm	○ weiß / white	100
--------	---------------------------	----------------	-----

830017	70 mm x 40 m x 12 mm	○ weiß / white	100
830020	70 mm x Ø 70 mm x 12 mm	○ weiß / white	100
830018	70 mm x 50 m x 12 mm	○ weiß / white	50
830047	70 mm x Ø 80 mm x 12 mm	○ weiß / white	50

830063	76 mm x Ø 60 mm x 12 mm	○ weiß / white	100
830021	76 mm x 40 m x 12 mm	○ weiß / white	50
830012	76 mm x 40 m x 12 mm	○ weiß / white	100
830019	76 mm x Ø 70 mm x 12 mm	○ weiß / white	100
830050	76 mm x Ø 70 mm x 17,5 mm	○ weiß / white	100
830048	76 mm x Ø 80 mm x 12 mm	○ weiß / white	50

830027	114 mm x Ø 60 mm x 12 mm	○ weiß / white	50
830033	114 mm x Ø 80 mm x 12 mm	○ weiß / white	30



DE	TELEFAX-ROLLEN – 52 g/m <sup>2</sup>
EN	FAX ROLLS – 52 g/m <sup>2</sup>



#		
810173	210 mm x 15 m x 12 mm	6
810021	210 mm x 30 m x 12 mm	6

**■ NACHHALTIG**  
Blue4est® wird ohne chemische Entwickler, wie z.B. Bisphenol A (BPA) hergestellt

**■ UMWELTFREUNDLICH**  
Blue4est® kann über den Altpapierkreislauf recycelt werden

**■ UNBEDENKLICH**  
Blue4est® ist für den direkten Lebensmittelkontakt zugelassen

**■ RESISTENT**  
Blue4est® ist beständig gegen Umwelteinflüsse wie Sonnenlicht oder Feuchtigkeit

**■ UNVERWECHSELBAR**  
Blue4est® unterscheidet sich nicht nur farblich von anderen Thermopapieren. Statt einer chemischen Reaktion auf Hitze erfolgt der Ausdruck auf einem rein physikalischen Prozess.



Das blaue Thermopapier aus dem Schwarzwald



MADE IN GERMANY

**DE** THERMOROLLEN BLUE4EST FÜR KASSEN, WAAGEN UND EC-CASH GERÄTE – 52 g/m<sup>2</sup>  
**EN** THERMAL ROLLS BLUE4EST FOR CASH REGISTERS, SCALES AND EC-CASH – 52 g/m<sup>2</sup>

#		für / for		
821819	80 mm x 80 m x 12 mm	EPSON	blaugrau	30
821821	80 mm x 80 m x 12 mm	EPSON	blaugrau	40
820099	80 mm x 80 m x 12 mm	EPSON	blaugrau	50
821806	80 mm x 50 m x 12 mm	EPSON	blaugrau	50
821768	57 mm x 15 m x 12 mm 0/1-farbig "Lastschrift" (SEPA)	EC-Cash	blaugrau	50
821822	57 mm x 15 m x 12 mm	EC-Cash	blaugrau	50
821852	57 mm x 25 m x 12 mm	EC-Cash	blaugrau	50
821790	57 mm x 40 m x 12 mm	EC-Cash	blaugrau	50



**DE** THERMOROLLEN BLUE4EST FÜR WAAGEN – 52 g/m<sup>2</sup>  
**EN** THERMAL ROLLS BLUE4EST FOR SCALES – 52 g/m<sup>2</sup>

#		für / for		
821823	58 mm x 50 m x 12 mm	Bizerba	blaugrau	50
821805	62 mm x 50 m x 12 mm	Mettler	blaugrau	50
821836	62 mm x 100 m x 12 mm	Mettler	blaugrau	27



**DE** SD-PAPIER ROLLEN (2-FACH)  
**EN** CARBONLESS ROLLS (DOUBLE)



#	Qual./qual.			
830090	CB/CF	44 mm x 25 m x 12 mm	○ ○ w/w / w/w	50
830092	CB/CF	57 mm x 20 m x 12 mm	○ ● w/g / w/y	50
830011	CB/CF	57 mm x 25 m x 12 mm	○ ○ w/w / w/y	50
830091	CB/CF	57 mm x 25 m x 12 mm	○ ● w/g / w/y	50
830057	CB/CF	70 mm x 25 m x 12 mm	○ ○ w/w / w/w	50
830056	CB/CF	76 mm x 25 m x 12 mm	○ ○ w/w / w/w	50

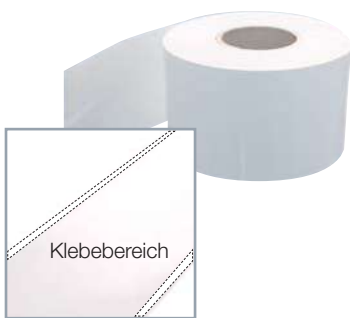

**DE** LINERLESS-ENDLOSETIKETTEN  
**EN** LINERLESS LABELS

- aus Thermo-TOP-Printerpapier
- mit hochwertigem Hotmelt-Kleber
- beidseitiger leimfreier Grifftrand
- made of Thermo-Top printer paper
- with high-quality hotmelt glue
- adhesive-free grip edge on both sides

#			
880115	58 mm x 65 mm x 40 mm	○ weiß / white	30
880258	58 mm x 100 mm x 40 mm	○ weiß / white	18

**DE** THERMO-ECO-HAFTETIKETTEN  
**EN** THERMAL ECO LABELS

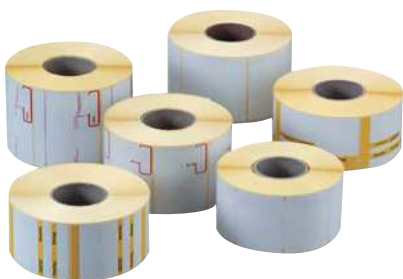

#		für / for	Stk./Rolle/ labels/roll	
880005	46,8 mm x 43 mm, 2-farbig "Standarddruck"	Mettler	1250	24
880006	46,8 mm x 62 mm, 2-farbig "Standarddruck"	Mettler	850	24
880007	46,8 mm x 81 mm, 2-farbig "Standarddruck"	Mettler	650	24
880008	46,8 mm x 102 mm, 2-farbig "Standarddruck"	Mettler	500	24
880019	58 mm x 43 mm, blanko	Bizerba	1040	20
880015	58 mm x 60 mm, blanko	Bizerba / Dibal	700	24
880026	58 mm x 60 mm, blanko	Bizerba	850	24
880174	68 mm x 45 mm, blanko	Bizerba	1000	30
880001	49 mm x 40 mm, blanko	Berkel	1000	20
880002	49 mm x 62 mm, blanko	Berkel	650	20
880003	49 mm x 81 mm, blanko	Berkel	500	20
880052	58 mm x 58 mm, blanko	Berkel	500	20
880053	58 mm x 76 mm, blanko	Berkel	400	20

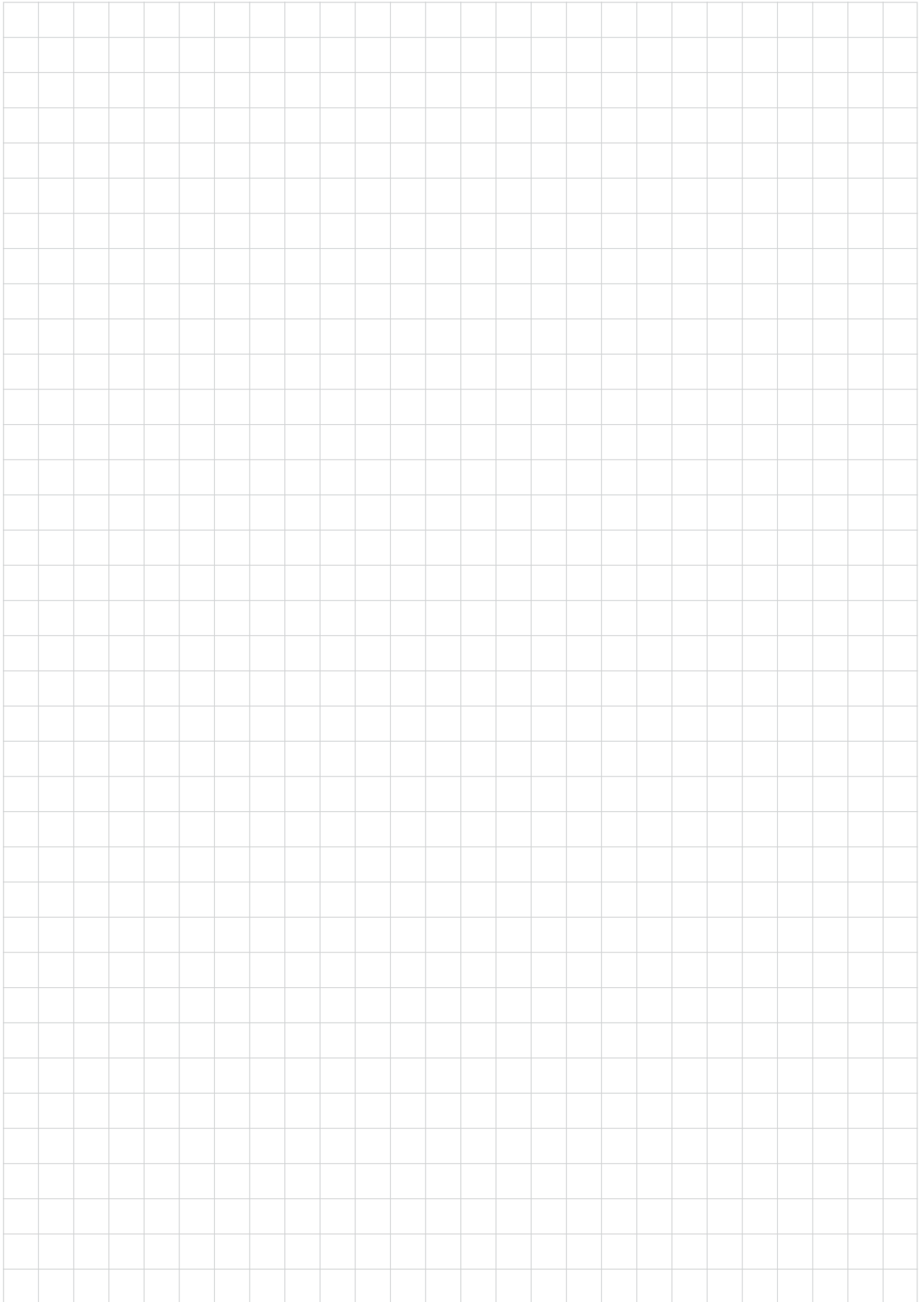

Gut präsentiert und gut sortiert – so verkauft es sich am besten!  
 Excellent presentation, Great assortment – Great Sales!

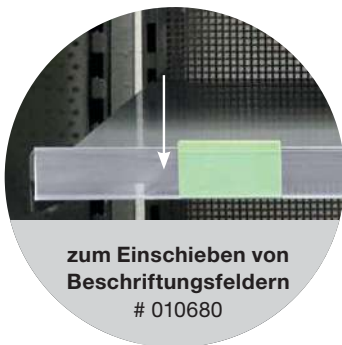

zum Einschieben von  
 Beschriftungsfeldern  
 # 010680

DE SCANNERSCHIENE / PREISSCHIENE  
 EN SCANNER BAR

- Material: PVC, transparent
- Selbstklebend
  - Optimal für Preisschilder oder Produktbeschreibungen
  - Stärke: 2 mm
  - 39 x 1000 mm

- Material: PVC, transparent
- Self-adhesive
  - Optimal for price tags or product descriptions
  - Thickness: 2 mm
  - 39 x 1000 mm



DE PIZZASCHAUFELTROLLEY  
 EN PIZZA PEEL DOLLY  
 IT CARRELLO PALA PER PIZZA  
 ES CARRO ESPÁTULA PARA PIZZA

STEEL



- Selbstmontage  
 • Inklusive 16 Schrauben  
 • Mit Ziehgriff  
 • 2/4 Lenkrollen feststellbar

- Self-assembly  
 • Including 16 screws  
 • With pull handle  
 • 2/4 swivel castors lockable

#	↗ mm	→ mm	↑ mm	⚖ kg
200680	440	440	483	7,94

SB #	Bezeichnung	Description
410300	Grundregal ohne Fachboden und ohne Haken /	Basic shelf without shelf and without hooks
410310	1x Fachboden 1000 mm x 330 mm	1x Shelf 1000 mm x 330 mm
010626	Schlaufen-Haken, Länge 180 mm, 50 Stück = 1 VE	Loop hook, length 180 mm – 50 pieces = 1 Set
010628	Einfach-Haken, Länge 180 mm, 50 Stück = 1 VE	Single hook, length 180 mm – 50 pieces = 1 Set
410306	Doppel-Schlaufen-Haken 200 mm extra stabil	Loop hook, length 200 mm very stable
410308	Einfach-Haken 200 mm extra stabil	Single hook, length 200 mm very stable
410311	Rollen für SB-Regal	Wheels for basic shelf
010680	Scannerschiene / Preisschiene 39 x 1000 mm	Scanner Bar 39 x 1000 mm

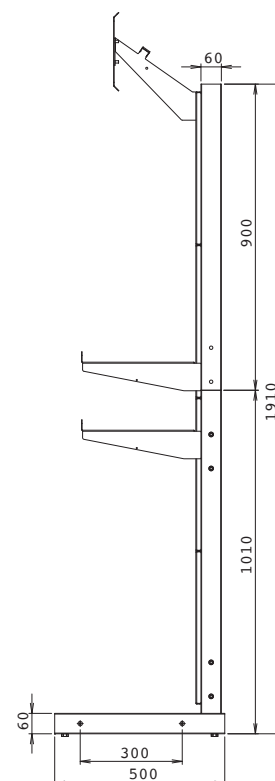
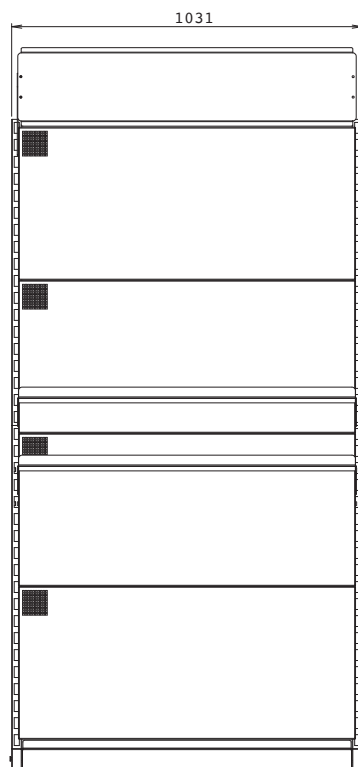
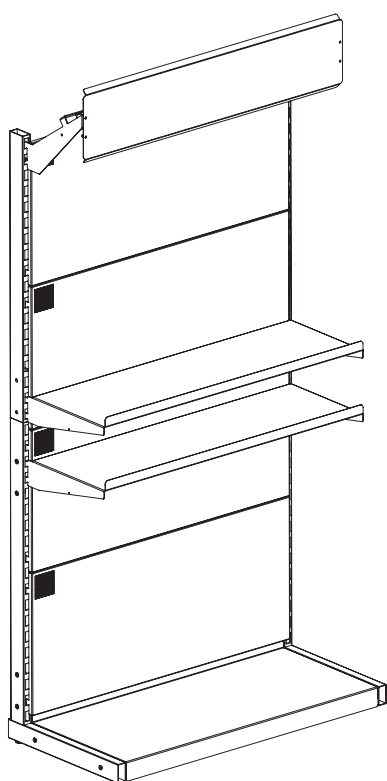

SB #	Bezeichnung	Description	Größe / Size	#
460001	Spritzbeutel	Pastry bag	1 – 28 cm	(350171)
460002	Spritzbeutel	Pastry bag	2 – 34 cm	(350172)
460003	Spritzbeutel	Pastry bag	3 – 40 cm	(350173)
460004	Spritzbeutel	Pastry bag	4 – 46 cm	(350174)
460005	Spritzbeutel	Pastry bag	5 – 50 cm	(350175)
460006	Spritzbeutel-Garnitur 9-tlg.	Pastry bag set 9-pcs.	1a – 31 cm	(350147)
460007	Tüllen-Set Kunststoff, Stern	Star tube set, plastic	3, 5, 7, 9, 11, 13 mm	(196530)
460008	Tüllen-Set Kunststoff, Loch	Plain tube set, plastic	3, 5, 7, 9, 11, 13 mm	(196540)
460009	Tüllen-Set Edelstahl, Stern	Star tube set, stainless steel	4, 6, 8, 10, 13, 15 mm	(197552, 197554, 197556, 197558, 197561, 197563)
460010	Tüllen-Set Edelstahl, Loch	Plain tube set, stainless steel	4, 6, 8, 10, 13, 15 mm	(197502, 197504, 197506, 197508, 197511, 197513)
460029	Abstecher, Edelstahl	Spatula, made of stainless steel	11 x 12 cm	(200600)
460030	Abstecher, Edelstahl	Spatula, made of stainless steel	1 x 12 cm	(200601)
460031	Abstecher, Edelstahl	Spatula, made of stainless steel	13,5 x 13,5 cm	(200602)
460038	Pinsel Holzgriff, 2-er Set	Brush wooden handle, set of 2	3 + 4 cm	(200204, 200206)
460051	Brötchen-Messer, 2-tlg. Set	Roll knives, set 2-pcs.	18 cm	(260961)
460052	Teigschaber-Set	Dough scraper set	4-teilig / 4 pcs.	(227364, 227360, 227352, 227365)
460069	Teig- und Pizzaschneider	Dough and Pizza Cutter	Ø 12,5 cm	(200116)

DE	ARTIKELNUMMERN-INDEX
EN	ITEM NUMBER INDEX
IT	INDICE PER CODICE ARTICOLO
ES	ÍNDICE POR CÓDIGO DEL ARTÍCULO

Art.-Nr. / code	S. / p.	Art.-Nr. / code	S. / p.	Art.-Nr. / code	S. / p.	Art.-Nr. / code	S. / p.	Art.-Nr. / code	S. / p.
<b>01</b>		110740	53	115072	76	115316	83	120112	154
010626	383	110940	53	115076	77	115317	83	120114	154
010628	383	110957	53	115077	78	115318	83	120116	154
010680	383	111300	51	115086	76	115321	84	120118	154
<b>10</b>		111400	51	115087	76	115322	84	120190	154
101000	49	111410	51	115088	76	115324	84	120191	154
101001	49	111420	51	115089	76	115325	84	120192	154
101002	49	111430	51	115090	75	115326	84	120193	154
101003	49	111440	51	115091	75	115327	84	120194	154
101004	49	111441	51	115092	75	115328	84	120195	154
101005	49	111442	51	115093	76	115330	84	120200	173
101006	49	111443	51	115094	76	115331	84	120400	173
101007	49	113040	190	115095	87	115333	85	120450	173
101011	49	113041	190	115096	87	115334	85	120550	172
101040	50	113042	190	115097	87	115335	85	120551	172
101043	50	113500	191	115098	77	115336	85	120553	172
101045	50	114001	190	115099	77	115338	81	120554	172
101050	50	114002	190	115131	74	115339	81	120555	172
101057	50	114003	190	115165	54	115340	83	120556	172
101100	50	114021	191	115184	87	115341	81	120557	172
101120	50	114022	191	115185	87	115342	82	120641	198
101140	50	114023	191	115211	77	115343	85	120650	119
103001	51	114024	191	115212	77	115344	83	120655	234
103032	51, 307	114026	191	115213	77	115345	83	120651	119
103040	51	114030	191	115215	77	115346	82	120653	119
103043	51	114050	191	115217	77	115347	82	120800	119
103045	51	114051	191	115220	73	115349	85	120801	119
103050	51	114052	191	115221	73	115350	85	120802	119
103057	51	114053	191	115222	74	115548	266	120810	118
103078	51, 307	114054	191	115223	78	116010	192	120811	118
103079	51	114055	191	115224	78	116013	192	120812	118
103100	51	114056	191	115225	78	116014	192	120950	119, 339
103140	51	114057	191	115226	73	116017	192	120960	119, 339
103141	51	114060	191	115227	76	116018	192	122018	56
103150	51	114061	191	115228	77	116022	192	122024	56
106140	51	115003	73	115229	78	116026	192	122035	56
106152	51	115005	73	115230	78	116028	192	122040	56
107782	54	115006	73	115231	78	116030	192	122045	56
107783	54	115007	73	115232	78	116033	192	122050	56
107784	54	115011	73	115233	75	116034	192	122055	56
107785	54	115012	73	115234	79	116036	192	122060	56
107790	54	115014	74	115235	79	116038	192	122065	56
107791	54	115015	74	115253	79	116040	192	122070	56
109100	50	115016	74	115254	79	116046	192	122075	56
109140	50	115017	74	115300	81	116100	192	122080	56
<b>11</b>		115024	74	115301	81	116110	192	122100	57
110100	53	115028	74	115302	81	116130	192	122105	57
110108	53	115029	74	115303	81	116210	192	122110	57
110110	53	115030	75	115304	81	116333	192	122250	56
110116	53	115036	75	115305	81	116410	192	122260	55
110140	53	115037	75	115306	82	116430	192	122270	56
110150	53	115039	75	115307	82	116440	192	122271	56
110500	53	115043	87	115308	82	116444	192	122272	56
110520	53	115044	87	115309	82	116450	192	122273	56
110540	53	115045	87	115310	82	116480	192	122274	56
110550	53	115046	87	115311	82	<b>12</b>		122275	56
110562	53	115050	87	115312	83	120100	173	122276	56
110700	53	115069	75	115313	83	120108	154	122277	56
110720	53	115071	76	115315	83	120110	154	122400	57



DE	ARTIKELNUMMERN-INDEX
EN	ITEM NUMBER INDEX
IT	INDICE PER CODICE ARTICOLO
ES	ÍNDICE POR CÓDIGO DEL ARTÍCULO

Art.-Nr. / code	S. / p.	Art.-Nr. / code	S. / p.	Art.-Nr. / code	S. / p.	Art.-Nr. / code	S. / p.	Art.-Nr. / code	S. / p.
122410	57	150621	283	152452	286	152663	276	153204	116
122420	57	150625	283	152453	286	152664	276	153210	116
122430	57	150630	282	152454	286	152665	276	153300	116
122700	57	150635	282	152455	286	152666	274	153351	153
122720	57	150700	341	152456	290	152667	278	153352	153
122740	57	150710	340	152460	291	152668	278	153400	116
122780	57	150715	340	152470	290	152669	278	153450	119
125025	56	150720	341	152475	342	152670	278	153451	119
125028	56	150730	340	152480	291	152671	278	153452	119
<b>13</b>		150790	341	152481	291	152672	278	153500	153
131030	344	150900	339	152482	290	152673	278	153510	153
131040	344	150910	339	152490	288	152674	278	153550	153
131050	344	150920	339	152491	288	152675	278	153560	153
131060	344	150930	339	152492	288	152676	278	153600	301
131070	344	151065	337	152493	291	152677	277	153601	301
131080	344	151066	337	152495	288	152679	273	153602	301
131800	344	151145	320	152496	288	152699	273	153603	301
131801	344	151170	336	152497	288	152700	279	153604	301
131802	344	151171	336	152541	284	152710	273	153610	301
132040	344	151172	336	152542	284	152711	273	153620	301
132070	344	151175	336	152543	285	152712	273	153900	304
132090	344	151190	336	152544	285	152840	270	153901	304
<b>14</b>		151195	320	152545	285	152845	270	153902	304
146003	193	151300	161	152547	285	152850	272	153903	304
146004	193	151301	161	152600	270	152851	272	153904	304
146005	193	151420	213	152609	270	152856	272	153905	304
146006	193	151430	213	152610	271	152860	272	153906	304
146007	193	151450	213	152611	271	152861	272	153908	304
146008	193	151460	213	152612	271	152862	272	153909	304
146040	195	152200	280	152613	271	152865	272	153935	304
147200	308	152210	280	152630	274	152880	275	153950	135, 305
148001	193	152230	280	152631	274	152898	277	153952	135, 305
148002	193	152235	280	152632	274	152915	131	153960	305
148003	193	152260	281	152633	275	152916	131	153961	304
148004	193	152280	281	152635	275	152917	131	153970	239
148005	193	152305	291	152636	275	152918	131	153975	239
148006	193	152395	288	152637	278	152919	131	153976	239
148007	193	152400	286	152638	275	152920	131	154001	188
148008	193	152401	286	152639	275	152922	289	154002	188
148016	193	152402	286	152640	275	152923	289	154003	188
148020	193	152403	286	152641	275	152924	289	154004	188
148026	193	152410	284	152642	275	152932	289	154010	188
148032	193	152411	284	152643	275	152933	289	154011	185
148040	193	152412	284	152644	275	152934	289	154012	185
148045	193	152413	287	152645	275	152970	283	154018	187
148050	193	152414	287	152646	275	152971	283	154020	188
148051	193	152416	287	152647	275	152972	283	154021	180
149004	195	152417	287	152648	275	152975	342	154024	180
149007	195	152418	287	152652	274	152990	289	154025	180
149008	195	152419	287	152653	274	152991	289	154026	180
149009	195	152420	285	152654	275	153000	279	154028	180
149010	195	152421	285	152655	276	153001	279	154030	180
149900	196	152422	285	152656	276	153090	331	154031	180
<b>15</b>		152430	285	152657	274	153091	331	154032	180
150000	161	152431	285	152658	276	153092	331	154033	180
150590	303	152432	285	152659	274	153093	330	154034	180
150600	343	152441	284	152660	276	153100	116	154037	185
150610	343	152442	284	152661	274	153110	116	154040	180
150620	282	152450	286	152662	276	153200	116	154041	180

DE	ARTIKELNUMMERN-INDEX
EN	ITEM NUMBER INDEX
IT	INDICE PER CODICE ARTICOLO
ES	ÍNDICE POR CÓDIGO DEL ARTÍCULO

Art.-Nr. / code	S. / p.	Art.-Nr. / code	S. / p.	Art.-Nr. / code	S. / p.	Art.-Nr. / code	S. / p.	Art.-Nr. / code	S. / p.
154042	180	154903	67	155410	151	156282	148	160004	164
154043	180	155009	93	155420	151	156284	147	160005	164
154050	183	155010	93	155430	151	156285	147	160006	166
154051	183	155011	93	155450	152, 333	156286	147	160012	164
154052	183	155040	180, 231	155451	152, 333	156287	147	160014	163
154053	183	155041	180, 231	155452	152, 333	156288	147	160015	111, 164
154054	183	155042	180, 231	155453	152, 333	156301	148	160018	167
154055	183	155043	180, 231	155454	152, 333	156302	148	160019	163
154056	183	155050	149	155455	152, 333	156321	148	160026	165
154059	183	155051	149	155456	152, 333	156322	148	160028	165
154060	182	155060	150, 332	155500	144	156327	147	160029	166
154061	182	155070	149	156008	56	156387	147	160034	165
154065	185	155071	149	156009	56	156465	147	160035	165
154066	185	155072	149	156013	148	156753	147	160036	165
154070	183	155073	149	156014	148	156754	147	160050	162
154071	183	155074	149	156015	148	156853	147	160051	163
154072	183	155100	150, 332	156017	148	156953	147	160052	166
154073	183	155110	150, 332	156075	152, 333	156980	148	160054	167
154074	183	155120	150, 332	156076	152, 333	156981	148	160056	167
154080	183	155200	150, 332	156077	147	157000	209	160100	163
154081	183	155210	150, 332	156078	147	157001	209	161020	165
154082	183	155220	150, 332	156079	147	157002	209	161030	165
154083	183	155300	150, 332	156083	147	157010	148	162080	146
154084	183	155310	150, 332	156110	45, 157, 307	157745	340	162100	146
154089	183	155320	150, 332	156111	45, 157, 307	157760	343	162120	146
154090	185	155330	150, 333	156112	45, 157, 307	157770	343	162140	146
154091	185	155331	150, 333	156113	45, 157, 307	158006	153	162160	146
154093	185	155332	150, 333	156115	156	158010	345	162180	146
154094	185	155340	150, 333	156116	156	158020	345	162200	146
154095	182	155341	150, 333	156124	156	158110	345	162220	146
154096	182	155342	150, 333	156125	157	158120	345	162240	146
154098	182	155350	150, 333	156126	157	158130	345	162260	146
154099	182	155351	150, 333	156128	156	158140	345	162280	146
154104	114, 351	155352	150, 333	156129	156	158150	345	162300	146
154203	115	155357	151	156130	156	158210	345	162320	146
154300	114	155361	151	156131	156	158220	345	162340	146
154420	115	155363	151	156161	147	158310	344	163075	146
154421	115	155365	151	156165	147	158320	344	163080	146
154422	115	155367	151	156166	147	158330	344	163120	146
154424	115	155369	151	156185	147	158410	345	163140	146
154427	115	155371	151	156186	147	158420	345	163160	146
154429	115	155373	151	156187	147	159150	52	163180	146
154430	115	155375	151	156205	147	159160	52	163200	146
154499	115	155377	151	156206	147	159240	52	163220	146
154702	288	155379	151	156207	147	159250	52	163240	146
154710	289	155380	151	156208	147	159260	52	163260	146
154711	289	155381	151	156225	147	159350	52	163280	146
154712	289	155382	151	156226	147	159360	52	163300	146
154720	289	155383	151	156227	147	159450	52	164120	146
154721	289	155384	151	156241	148	159460	52	164140	146
154722	289	155385	151	156245	147	159700	351	164160	146
154810	364	155386	151	156246	147	159701	351	164180	146
154812	198	155387	151	156247	147	159702	351	164200	146
154813	349	155388	151	156261	148	159900	303	164220	146
154840	109, 231	155389	151	156265	147	159902	303	164240	146
154841	109, 231	155390	151	156266	147	<b>16</b>		164260	146
154842	109, 231	155391	151	156267	147	160001	164	164280	146
154900	67	155399	151	156268	147	160002	164	164300	146
154901	67	155400	151	156281	148	160003	164	164400	147

DE	ARTIKELNUMMERN-INDEX
EN	ITEM NUMBER INDEX
IT	INDICE PER CODICE ARTICOLO
ES	ÍNDICE POR CÓDIGO DEL ARTÍCULO

Art.-Nr. / code	S. / p.	Art.-Nr. / code	S. / p.	Art.-Nr. / code	S. / p.	Art.-Nr. / code	S. / p.	Art.-Nr. / code	S. / p.
164401	147	170051	127, 327	171103	197	176120	314	182000	160
164402	147	170052	127, 327	171104	197	176140	314	182005	160
164900	149	170053	127, 327	171105	197	176160	314	182010	160
166001	98	170054	127, 327	171106	197	176180	314	182020	160
166002	98	170070	127, 327	172000	190	177002	316	182030	160
166003	98	170071	127, 327	172001	190	177003	316	182040	160
166004	98	170072	127, 327	172002	190	177010	315	182045	160
166005	98	170073	127, 327	172003	190	177011	315	<b>19</b>	
166006	98	170074	127, 327	172100	233	177020	316	190210	229
166007	98	170075	127, 327	172101	233	177021	316	190220	229
166008	98	170079	126, 326	172200	232	177022	316	190230	229
166009	98	170080	126, 326	172201	232	177030	315	190240	229
166010	98	170081	126, 326	172202	232	177031	315	190300	233
166022	98	170082	126, 326	172203	232	177032	315	190305	233
166023	98	170083	126, 326	172204	232	177040	315	190308	233
166024	98	170084	126, 326	172300	231	177041	315	190310	233
166025	98	170085	126, 326	172370	200, 312	177042	315	191095	125
166026	98	170101	137	172401	198	177050	315	193030	332
166027	98	170107	137	172413	200	177060	316	193031	332
166028	98	170108	137	172414	200	178000	314	193032	332
166029	98	170109	137	172415	199	178001	314	193033	332
166030	98	170110	137	172416	199	178002	314	195010	229
166032	98	170111	137	172430	201	178003	314	195015	229
166034	98	170112	137	172431	201	178004	314	195020	229
166035	98	170113	137	172432	201	178005	314	195025	229
166037	98	170114	137	172460	312	178010	318	195030	229
166080	125	170115	137	172461	312	178011	318	195035	229
166081	125	170116	137	172462	312	178012	318	195040	229
166082	125	170117	137	172463	312	<b>18</b>		195045	229
166083	125	170118	137	172464	312	180202	139	195050	229
166100	88	170120	136	172465	312	180210	139	195055	229
166101	88	170121	136	172500	184	180220	139	195060	229
166102	88	170135	136	172510	184	180230	139	195100	228
166103	88	170136	136	172520	185	180240	139	195110	228
166104	88	170137	136	172530	185	180250	139	195120	228
166105	88	170138	136	172600	201	180260	139	195130	228
166106	88	170139	136	172610	201	180270	139	195140	228
166107	88	170140	136	172630	201	180280	139	195150	228
166108	88	170145	136	172670	200	180300	139	195180	228
166109	88	171000	196	172700	182	180310	139	195190	228
166110	88	171001	196	172710	182	180320	139	195210	228
166120	88	171002	196	175000	313	180330	139	195220	228
166121	88	171003	196	175001	313	180340	139	195230	228
166130	159	171004	196	175002	313	180350	139	195250	228
166140	159	171005	196	175003	313	180360	139	195260	228
<b>17</b>		171020	200	175004	313	180370	139	195290	228
170010	127, 327	171030	200	175005	313	180380	139	195400	229
170011	127, 327	171040	199	175006	313	180400	139	195405	229
170012	127, 327	171041	199	175007	313	180410	139	195410	229
170013	127, 327	171042	199	175030	314	180420	139	195415	229
170014	127, 327	171050	199	175032	314	180430	139	195420	229
170015	127, 327	171051	199	175033	314	180440	139	195425	229
170016	126, 326	171052	199	175037	314	180450	139	195430	229
170040	126, 326	171061	199	175040	314	180460	139	195435	229
170041	126, 326	171062	199	175043	314	181014	160	195440	229
170042	126, 326	171063	199	175044	314	181100	160	195450	229
170043	126, 326	171064	199	175047	314	181160	160	195700	231
170044	126, 326	171100	197	176080	314	181170	160	196015	338
170050	127, 327	171101	197	176100	314	181200	160	196020	338

DE	ARTIKELNUMMERN-INDEX
EN	ITEM NUMBER INDEX
IT	INDICE PER CODICE ARTICOLO
ES	ÍNDICE POR CÓDIGO DEL ARTÍCULO

Art.-Nr. / code	S. / p.	Art.-Nr. / code	S. / p.	Art.-Nr. / code	S. / p.	Art.-Nr. / code	S. / p.	Art.-Nr. / code	S. / p.
196030	338	197329	216	197552	214	198901	203	199064	328
196050	338	197330	217	197553	214	198902	203	199065	328
196060	338	197331	217	197554	214	198903	203	199069	141
196500	226	197332	217	197555	214	198904	203	199070	109
196501	226	197333	216	197556	214	198905	203	199075	109
196502	226	197334	216	197557	214	198910	203	199095	318
196503	226	197335	216	197558	214	198911	203	199096	318
196504	226	197336	216	197559	214	198912	203	199097	318
196505	226	197337	216	197560	214	198913	203	199098	318
196506	226	197340	217	197561	214	198914	203	199120	238
196507	226	197400	218	197562	214	198915	203	199121	238
196520	226	197401	218	197563	214	198920	203	199122	238
196521	226	197402	218	197564	214	198950	202	199123	238
196522	226	197403	220	197565	214	198951	202	199124	238
196523	226	197405	218	197566	214	198952	202	199125	238
196524	226	197406	218	197570	221	198960	202	199126	238
196525	226	197407	218	197571	221	198961	202	199128	238
196526	226	197408	218	197572	221	198962	202	199129	238
196527	226	197410	218	197573	221	199000	132, 324	199130	238
196528	226	197411	218	197574	221	199002	132, 324	199150	100
196530	226	197412	219	197575	221	199003	132, 324	199160	149
196540	226	197413	219	197576	222	199004	132, 324	199161	149
196550	227	197414	219	197577	222	199005	132, 324	199162	149
196560	227	197415	219	197578	222	199006	132, 324	199163	102
196570	227	197417	219	197579	222	199007	132, 324	199164	102
196580	227	197418	219	197580	222	199008	132, 324	199165	102
196600	224	197420	219	197581	222	199009	132, 324	199166	102
196610	224	197421	219	197582	222	199010	132, 324	199167	102
196620	224	197422	219	197583	222	199011	132, 324	199168	102
196630	224	197423	220	197584	222	199012	132, 324	199169	102
196660	224	197424	220	197595	223	199013	132, 324	199170	102
197032	223	197425	220	198000	158	199014	132, 324	199171	104
197033	223	197426	220	198001	158	199015	132, 324	199172	104
197060	223	197427	220	198002	158	199017	132, 324	199173	96
197136	214	197428	220	198003	158	199018	132, 324	199174	96
197180	215	197429	220	198004	158	199019	132, 324	199175	96
197300	217	197430	220	198005	158	199026	328	199176	96
197301	217	197500	215	198006	158	199027	328	199177	96
197302	217	197501	215	198007	158	199028	328	199178	96
197303	221	197502	215	198008	158	199030	196	199179	96
197310	216	197503	215	198009	158	199031	335	199180	96
197311	216	197504	215	198010	158	199032	335	199181	96
197312	216	197505	215	198012	158	199033	238	199182	96
197313	216	197506	215	198013	158	199034	238	199183	96
197314	216	197507	215	198014	158	199035	196	199184	96
197315	216	197508	215	198015	158	199036	196	199210	142
197316	216	197509	215	198017	158	199038	196	199211	142
197317	216	197510	215	198840	317	199039	196	199212	142
197318	216	197511	215	198841	317	199052	142	199220	142
197319	216	197512	215	198870	318	199053	142	199221	142
197320	216	197513	215	198871	318	199054	142	199222	142
197321	216	197514	215	198872	318	199055	142	199223	142
197322	216	197515	215	198873	318	199056	142	199328	317
197323	216	197516	215	198874	318	199057	142	199329	317
197324	216	197517	215	198875	318	199058	142	199330	317
197325	216	197518	215	198890	319	199059	328	199331	317
197326	216	197519	215	198891	319	199060	328	199361	334
197327	216	197550	214	198892	319	199061	328	199362	334
197328	216	197551	214	198900	203	199063	328	199364	335

DE	ARTIKELNUMMERN-INDEX
EN	ITEM NUMBER INDEX
IT	INDICE PER CODICE ARTICOLO
ES	ÍNDICE POR CÓDIGO DEL ARTÍCULO

Art.-Nr. / code	S. / p.	Art.-Nr. / code	S. / p.	Art.-Nr. / code	S. / p.	Art.-Nr. / code	S. / p.	Art.-Nr. / code	S. / p.
199365	335	199621	230	199987	149	200203	120	200420	112
199370	317	199622	230	199988	149	200204	120	200423	112
199371	317	199623	230	199940	302	200205	120	200424	112
199372	317	199624	230	199999	302	200206	120	200490	283
199373	317	199625	230	<b>20</b>		200207	120	200491	283
199374	317	199626	230	200001	114, 351	200208	120	200492	283
199375	317	199629	230	200002	114, 351	200209	120	200493	283
199400	133	199630	230	200003	114	200210	120	200494	283
199401	133	199641	92	200004	115	200212	120	200495	283
199402	133	199642	92	200005	119, 350	200213	120	200496	283
199403	133	199643	92	200006	119, 350	200214	120	200499	135
199404	133	199650	94	200007	119, 350	200215	120	200500	110, 312
199405	133	199651	94	200010	140, 325	200216	120	200501	110, 312
199406	133	199652	94	200011	140, 325	200217	120	200502	110, 312
199409	332	199653	94	200012	140, 325	200218	120	200503	110, 312
199410	332	199654	94	200013	140, 325	200219	120	200504	110, 312
199411	332	199655	94	200014	140, 325	200234	118	200600	109
199412	332	199656	92	200015	140, 325	200235	118	200601	109
199420	133	199657	92	200022	128, 323	200236	118	200602	109
199421	133	199658	92	200023	138	200237	118	200610	110, 239
199422	133	199659	94	200024	138	200238	119	200611	110, 239
199423	133	199660	94	200025	138	200239	119	200620	110
199424	133	199661	94	200026	138	200240	143	200621	110
199425	133	199662	94	200027	138	200241	143	200622	110
199500	90	199663	94	200096	118	200245	223	200625	350
199501	90	199700	100	200097	118	200260	119	200626	350
199502	90	199710	100	200102	194	200261	119	200627	350
199503	90	199720	100	200103	194	200271	120	200630	143
199504	90	199730	100	200104	194	200272	120	200631	143
199505	90	199740	100	200105	194	200273	120	200632	143
199506	90	199750	100	200106	194	200274	120	200633	143
199507	90	199760	102	200108	194	200275	120	200634	143
199508	90	199761	102	200109	194	200276	120	200635	143
199510	90	199770	102	200114	115	200280	120	200640	347
199511	90	199780	104	200115	119, 350	200285	121	200641	347
199513	92	199790	104	200116	119, 350	200286	121	200642	347
199520	92	199800	104	200123	118	200287	121	200643	347
199530	93	199820	104	200126	118	200288	121	200644	346
199570	104	199830	104	200127	118	200290	121	200646	350
199571	104	199840	104	200128	118	200291	121	200647	347
199580	125	199850	104	200129	118	200292	121	200650	347
199581	125	199860	104	200149	141, 325	200293	121	200651	347
199582	125	199870	104	200150	141, 325	200299	120	200652	347
199584	93	199880	100	200160	118	200300	143	200653	347
199585	125	199883	100	200161	118	200301	143	200660	347
199586	125	199884	100	200162	118	200312	120	200661	347
199590	155	199885	100	200163	118	200313	120	200662	347
199591	155	199886	102	200164	118	200346	138	200663	347
199610	230	199887	100	200170	141, 325	200347	138	200648	346
199611	230	199888	100	200179	141, 325	200348	138	200649	346
199612	230	199890	100	200182	114, 351	200349	138	200680	382
199613	230	199891	100	200192	134	200350	138	200700	110
199614	230	199892	328	200194	134	200351	138	200701	110
199615	230	199893	328	200195	134	200352	138	200702	109
199616	230	199894	328	200196	134	200353	138	200703	109
199617	230	199895	328	200197	134	200354	138	200710	110, 239
199618	230	199950	302	200200	120	200355	138	200750	111
199619	230	199960	141	200201	120	200408	140, 325	200751	111
199620	230	199986	149	200202	120	200409	140, 325	200752	111

DE	ARTIKELNUMMERN-INDEX
EN	ITEM NUMBER INDEX
IT	INDICE PER CODICE ARTICOLO
ES	ÍNDICE POR CÓDIGO DEL ARTÍCULO

Art.-Nr. / code	S. / p.	Art.-Nr. / code	S. / p.	Art.-Nr. / code	S. / p.	Art.-Nr. / code	S. / p.	Art.-Nr. / code	S. / p.
200760	111	201330	122	202200	32	206010	140, 325	226660	177
200761	111	201400	122	202205	32	206011	140, 325	226670	177
200762	111	201410	122	202210	32	206012	140, 325	226680	177
200770	112	201420	122	202215	32	206013	140, 325	226690	177
200771	112	201430	122	202220	32	206014	140, 325	226720	177
200772	112	201440	122	202225	32	206015	140, 325	226730	177
200773	112	201450	122	202294	121	206112	140, 325	226740	177
200802	138	201451	122	202295	121	206113	140, 325	226750	177
200830	33	201500	122	202296	121	206114	140, 325	226850	177
200840	33	201510	122	202297	121	206115	140, 325	226860	177
200850	33	201520	122	202400	194	<b>22</b>		226870	177
200855	33	201600	122	202401	194	220108	154	226880	177
200865	33	201610	122	202402	194	220110	154	226890	177
200860	33	201620	122	202403	194	220112	154	227002	112
200870	33	201630	122	202404	194	220114	154	227003	178
200875	33	201700	122	202405	194	220116	154	227004	178
200880	33	201710	122	202406	194	220118	154	227007	178
200881	33	201720	122	202407	194	220119	154	227008	178
200882	33	201730	122	202408	194	220120	154	227009	178
200890	30	201800	122	202409	194	220122	154	227010	178
200891	30	201810	122	202410	194	220124	154	227011	178
200892	30	201820	122	202411	194	220126	154	227012	178
200893	30	201830	122	202412	194	220128	154	227013	178
200899	155	201850	122	202413	194	221020	130	227014	178
200900	155	201851	122	202414	194	221021	130	227015	178
200915	155	201852	122	203300	118	221022	130	227016	178
200925	111	201901	124	203310	118	221023	130	227023	181
200926	111	201902	124	203400	145	221024	130	227025	186
200927	111	201903	124	203401	145	221025	130	227026	186
200928	111	201904	124	203402	145	221026	130	227027	186
200929	111	201905	124	203403	145	225050	175	227028	187
200940	113	201906	124	203404	145	225060	175	227029	186
200941	113	201907	124	203405	145	225070	175	227031	189
200942	113	202000	31	203406	145	225080	175	227037	189
200943	113	202005	31	203407	145	225090	175	227094	178
200944	113	202010	31	203408	145	225120	175	227095	178
200945	113	202015	31	203409	145	225130	175	227096	178
200950	152, 333	202020	31	203410	145	225140	175	227097	178
200960	31, 129	202025	31	203411	145, 351	225150	175	227098	181
200962	31, 129	202030	31	203412	145, 351	225250	175	227099	60, 112
200963	31, 39, 129	202035	31	203413	145, 351	225260	175	227125	186
200970	31, 129	202085	17	203414	145, 351	225270	175	227126	186
200971	31, 129	202086	21	203415	145, 351	225280	175	227127	186
201000	124	202089	39	203416	145, 351	225290	175	227128	187
201010	124	202090	52	203417	145, 351	226350	176	227129	186
201020	124	202091	52	203418	145, 351	226360	176	227130	179
201030	124	202092	17	203419	145	226370	176	227131	179
201040	124	202094	18	203420	145	226380	176	227132	179
201050	124	202095	39	203421	144	226390	176	227133	179
201200	122	202096	17	203422	144	226420	176	227134	179
201205	122	202097	22	203429	113	226430	176	227135	179
201210	122	202098	31	203430	113	226440	176	227136	179
201220	122	202099	17	203431	113	226450	176	227137	179
201230	122	202170	33, 346	203432	113	226550	176	227138	179
201300	122	202171	33, 346	203433	113	226560	176	227139	179
201302	122	202172	33, 346	203434	113	226570	176	227140	179
201305	122	202173	33, 346	203435	113	226580	176	227141	179
201310	122	202180	32, 129	203436	113	226590	176	227142	174
201320	122	202181	32, 129	203437	113	226650	177	227144	174

DE	ARTIKELNUMMERN-INDEX
EN	ITEM NUMBER INDEX
IT	INDICE PER CODICE ARTICOLO
ES	ÍNDICE POR CÓDIGO DEL ARTÍCULO

Art.-Nr. / code	S. / p.	Art.-Nr. / code	S. / p.	Art.-Nr. / code	S. / p.	Art.-Nr. / code	S. / p.	Art.-Nr. / code	S. / p.
227150	189	228300	372	255320	234	260740	360	261800	364
227160	189	228301	372	255350	234	260742	360	261810	364
227170	189	228302	372	255800	237	260800	366	262518	356
227180	189	228303	372	255850	237	260801	366	262522	356
227200	159	228304	372	255860	237	260802	366	262600	356
227214	200	228305	372	255880	237	260803	366	262601	356
227220	187	228310	372	<b>26</b>		260804	366	262602	356
227225	186	228311	372	260000	362	260805	366	262612	357
227227	186	228312	372	260010	362	260806	366	262616	357
227229	186	228313	372	260020	362	260807	366	262621	357
227230	107	228314	372	260021	362	260810	369	262626	357
227231	107	228315	372	260022	362	260811	366	262631	357
227232	107	228316	372	260023	362	260812	366	262636	343, 357
227233	107	228330	373	260024	362	260813	366	262640	356
227235	107	228332	373	260025	362	260814	366	262712	357
227240	106	228333	373	260030	361	260815	366	262721	357
227241	106	228340	374	260031	361	260816	369	262726	357
227242	106	228350	373	260032	361	260817	369	262731	357
227243	106	228351	373	260033	361	260818	369	262736	357
227244	106	228352	373	260034	361	260819	369	262825	357
227246	108	228353	373	260035	361	260820	369	264036	354
227247	108	228354	373	260040	361	260830	367	264131	354
227350	107	228355	373	260041	361	260831	367	264136	354
227351	107	228360	373	260042	361	260832	367	264226	354
227352	107	228361	373	260043	361	260833	367	264231	354
227355	107	228362	373	260044	361	260834	367	264236	354
227356	107	228363	373	260050	361	260835	367	264931	355
227360	107	228364	373	260099	371	260836	367	265326	355
227363	107	228365	373	260350	367	260837	367	265426	355
227364	107	228370	373	260360	367	260838	367	265431	355
227365	107	228371	373	260370	367	260839	367	265436	355
227550	184	228372	373	260561	359	260840	367	265526	355
227551	184	228373	373	260571	359	260841	367	265531	355
227552	184	228374	373	260582	360	260850	369	265536	355
227575	48, 190	228375	373	260592	360	260860	368	265626	355
227576	48, 190	228390	374	260600	360	260861	368	265631	355
227577	48, 191	228391	374	260610	359	260862	368	265636	355
227578	48, 191	228395	373	260611	359	260863	368	265826	355
227601	181	<b>23</b>		260612	359	260864	368	265921	356
227611	181	230030	238	260630	358	260865	368	265926	356
227621	181	230102	131	260631	358	260868	334	266055	361
227622	181	230112	131	260632	358	260869	334	266960	54, 302
227640	181	230122	131	260640	358	260876	368	268013	370
227650	184	230129	131	260641	358	260877	368	268015	370
227651	184	230130	130	260642	358	260878	368	268113	370
227750	108	230150	323	260650	359	260890	363	268115	370
227752	108	230160	323	260651	359	260900	371	268213	370
227756	108	<b>25</b>		260652	359	260901	371	268216	370
227757	108	250001	134	260660	367	260902	371	268218	370
227763	108	250002	134	260661	367	260903	371	268320	370
227850	108	250003	134	260670	363	260905	371	268325	370
227852	108	250004	134	260671	363	260906	371	268421	370
227856	108	250005	134	260672	363	260910	374	268424	370
227857	108	250006	134	260673	363	260960	363	<b>27</b>	
227863	108	250007	134	260677	363	260961	363	270000	375
228128	319	250008	134	260700	369	260962	363	270001	375
228129	319	250009	134	260701	369	260963	363	270002	375
228130	374	255000	236	260702	369	260964	363	270003	375
228131	374	255010	236	260703	369	260965	363	270004	375
				260730	359				

DE	ARTIKELNUMMERN-INDEX
EN	ITEM NUMBER INDEX
IT	INDICE PER CODICE ARTICOLO
ES	ÍNDICE POR CÓDIGO DEL ARTÍCULO

Art.-Nr. / code	S. / p.	Art.-Nr. / code	S. / p.	Art.-Nr. / code	S. / p.	Art.-Nr. / code	S. / p.	Art.-Nr. / code	S. / p.
270005	375	310003	168	350600	208	383110	42	410311	383
270006	375	310004	171	350601	208	383200	43	<b>42</b>	
<b>28</b>		310009	171	350650	208	385000	34	421002	261
281001	29, 284, 287	310019	169	<b>38</b>		385009	37	421003	261
281002	29	310023	170	381000	43	385010	34	421006	251
281003	29	310024	170	381005	43	385015	35	421012	241
281004	29	310027	171	381006	43	385029	37	421015	249
281005	29	310031	169, 329	381007	43	385030	34	421019	250
281006	29, 284, 287	310032	169, 329	381020	43	385035	35	421023	241
281007	29	310085	169, 329	381021	43	385040	34	421024	254
281008	29	310090	171	381022	43	385050	34	421025	254
281009	29	310099	169, 329	381050	41	385099	37	421027	249
281010	29	310103	168	381051	41	385100	35	421028	257
281011	29, 284, 287	310111	170	381052	41	385120	35	421031	254
281012	29	310115	170	381054	41	385180	34	421033	247
281013	29	<b>33</b>		381057	41	385200	35	421036	254
281014	29	330002	207	381058	41	385205	35	421037	248
281015	29	330003	207	381060	41	385500	38	421045	254
281016	29	330004	207	381061	42	385510	38	421046	249
281017	29	330005	207	381063	41	385550	38	421048	247
281018	29	330007	207	381100	42	385551	38	421050	243
281020	28, 202	<b>35</b>		381101	42	<b>39</b>		421053	243
281021	28, 202	350080	206	381102	42	391050	212	421058	247
281030	28	350081	206	381106	42	391200	210	421078	246
281031	28	350082	206	381108	42	391210	210	421079	246
281032	28	350083	206	381109	42	391220	210	421081	254
281033	28	350084	206	381110	42	391230	210	421082	254
281040	23	350085	206	381127	43	391240	210	421084	266
281041	29	350086	206	381150	55	391320	211	421089	249
281042	29	350087	206	381151	55	391330	211	421092	257
<b>29</b>		350088	206	381200	43	391400	212	421093	249
290000	128, 322	350089	206	381201	43	391410	212	421094	254
290010	128, 322	350090	206	381430	49	391530	172	421095	249
290020	128, 322	350144	208	381432	49	391535	172	421104	249
290030	128, 322	350145	208	382000	41	391550	172	421129	251
290040	128, 322	350147	208	382010	41	391800	210	421132	264
290050	128, 322	350170	206	382020	41	391810	210	421134	247
290070	128, 322	350171	206	382030	41	391820	210	421145	242
290071	128, 322	350172	206	382040	41	391850	212	421146	242
290072	128, 322	350173	206	382100	42	391900	209	421147	242
290073	128, 322	350174	206	382110	42	391902	209	421148	242
290074	128, 322	350175	206	382325	48	391920	211	421156	257
290075	128, 322	350176	206	382500	44, 306	391950	36	421157	262
290160	337	350177	206	382501	44, 306	391951	36	421158	261
290170	337	350178	206	382502	44, 306	391952	36	421170	266
290200	130, 239, 322	350179	206	382510	44, 306	391953	36	421173	257
290300	323	350180	206	382511	44, 306	391954	36	421189	254
292000	321	350199	213	382512	44, 306	391960	36	421191	249
292001	321	350250	207	382520	44, 306	391961	36	421197	247
292002	321	350251	207	382521	44, 306	391970	36	421209	245
292003	321	350252	207	382522	44, 306	391971	36	421214	241
292004	321	350253	207	382530	45, 307	391972	36	421216	242
292005	321	350254	207	382531	45, 307	391980	36, 53	421217	261
292006	321	350255	207	382532	45, 307	399000	213	421218	242
292007	321	350256	207	382533	45, 307	<b>41</b>		421219	248
292008	321	350257	207	382534	45, 307	410300	383	421224	252
<b>31</b>		350258	207	382535	45, 307	410306	383	421225	254
310001	168	350259	207	382536	45, 307	410308	383	421226	249
310002	168	350260	207	382562	44, 306	410310	383	421251	243



DE	ARTIKELNUMMERN-INDEX
EN	ITEM NUMBER INDEX
IT	INDICE PER CODICE ARTICOLO
ES	ÍNDICE POR CÓDIGO DEL ARTÍCULO

Art.-Nr. / code	S. / p.	Art.-Nr. / code	S. / p.	Art.-Nr. / code	S. / p.	Art.-Nr. / code	S. / p.	Art.-Nr. / code	S. / p.
421252	243	421529	250	421779	255	421921	259	430007	267
421253	243	421533	255	421780	258	421922	259	430008	267
421254	243	421537	243	421781	255	421923	260	<b>45</b>	
421255	244	421540	250	421782	259	421924	260	450500	235
421256	264	421544	257	421784	256	421929	260	450510	235
421258	261	421545	257	421786	244	421930	260	450520	235
421263	254	421554	245	421794	256	421931	251	450900	266
421266	243	421555	258	421795	253	421932	260	<b>46</b>	
421280	241	421558	250	421796	264	421933	251	460001	383
421289	248	421559	258	421797	262	421934	251	460002	383
421290	248	421561	248	421799	256	421935	260	460003	383
421291	262	421564	258	421826	247	421936	260	460004	383
421292	262	421568	247	421830	247	421937	241	460005	383
421294	266	421575	258	421840	256	421938	251	460006	383
421296	241	421576	242	421842	256	421939	260	460007	383
421297	241	421582	244	421847	253	422009	255	460008	383
421300	248	421585	261	421848	256	422018	253	460009	383
421301	254	421586	266	421853	253	422022	262	460010	383
421302	246	421588	264	421854	264	422037	245	460029	383
421317	243	421597	253	421858	256	422038	246	460030	383
421321	253	421611	264	421859	256	422054	253	460031	383
421327	250	421612	265	421865	253	422110	265	460038	383
421330	257	421617	258	421866	256	422116	262	460051	383
421333	246	421622	256	421867	263	422121	242	460052	383
421342	261	421623	266	421868	246	422122	242	460069	383
421354	266	421628	252	421869	246	422162	265	<b>53</b>	
421357	253	421630	258	421870	246	422169	255	530000	296
421358	244	421635	245	421872	264	422251	262	530001	296
421362	243	421637	247	421873	244	422252	262	530002	296
421367	263	421638	255	421874	251	422253	263	530003	296
421383	243	421640	244	421877	250	422254	263	530005	297
421384	248	421641	244	421878	246	422276	265	530010	296
421387	261	421642	265	421880	250	422295	263	530011	296
421393	248	421643	252	421883	256	422343	249	530012	296
421397	255	421646	258	421885	256	422360	253	530013	296
421406	246	421647	255	421887	253	422361	262	530015	297
421411	251	421648	262	421888	244	422370	250	530020	296
421417	241	421655	246	421888	244	422371	259	530021	296
421419	257	421656	244	421889	244	422391	260	530022	296
421421	263	421664	244	421891	245	422392	258	530023	296
421423	252	421665	264	421892	242	422395	245	530025	297
421428	252	421666	251	421893	242	422395	245	530030	296
421431	263	421667	264	421898	264	422431	250	530030	296
421439	246	421669	247	421899	264	422432	248	530031	296
421443	252	421673	255	421901	250	422436	265	530032	296
421456	253	421674	252	421903	257	422437	265	530033	296
421457	251	421674	252	421904	257	422438	265	530035	297
421479	257	421676	255	421905	259	429990	240	530040	296
421480	266	421685	265	421906	259	429991	240	530041	296
421483	249	421726	241	421907	245	429992	240	530042	296
421493	252	421727	251	421908	259	429993	240	530043	296
421495	262	421739	244	421909	263	429994	240	530045	297
421498	249	421744	242	421910	245	429995	240	530050	296
421513	241	421745	264	421911	259	429996	240	530051	296
421516	243	421746	251	421912	259	429997	240	530055	297
421517	241	421753	258	421915	259	429998	240	530060	297
421519	247	421754	258	421916	259	429999	240	530061	297
421521	257	421760	255	421917	247	<b>43</b>		530062	297
421526	241	421764	258	421919	250	430000	267	530063	297
		421769	265	421920	259	430001	267	530064	297

DE	ARTIKELNUMMERN-INDEX
EN	ITEM NUMBER INDEX
IT	INDICE PER CODICE ARTICOLO
ES	ÍNDICE POR CÓDIGO DEL ARTÍCULO

Art.-Nr. / code	S. / p.	Art.-Nr. / code	S. / p.	Art.-Nr. / code	S. / p.	Art.-Nr. / code	S. / p.	Art.-Nr. / code	S. / p.
530070	297	530217	299	531006	310	650165	26, 352	820191	376
530071	297	530220	298	531010	310	650240	26, 352	820215	377
530072	297	530221	298	531011	310	650330	26, 352	820227	377
530073	297	530222	298	531012	310	650395	26, 352	820239	377
530074	297	530223	298	531013	310	650990	26, 352	820241	376
530100	294	530224	298	531014	310	651165	27, 353	820242	377
530101	294	530225	298	531015	310	651260	27, 353	820250	377
530102	294	530226	299	531020	311	651990	27, 353	820268	376
530103	294	530227	299	531021	311	652280	27, 353	820286	376
530105	295	530230	298	531022	311	652990	27, 353	820298	376
530110	294	530231	298	531023	311	<b>66</b>		820302	378
530111	294	530232	298	531024	311	660215	24	820306	377
530112	294	530233	298	531030	311	660270	24	820319	378
530113	294	530234	298	531031	311	660990	25	820320	378
530115	295	530235	298	531032	311	<b>69</b>		820321	378
530120	294	530236	299	531040	311	690000	16, 23	820335	377
530121	294	530237	299	531041	311	690010	16	820404	376
530122	294	530240	298	531042	311	690020	21	820407	376
530123	294	530241	298	531050	309	690030	27, 353	820408	377
530125	295	530242	298	531051	309	690100	17	820409	377
530130	294	530243	298	531052	309	<b>71</b>		820410	376
530131	294	530244	298	531060	311	710000	203	820411	376
530132	294	530245	298	531061	311	711000	203	820413	376
530133	294	530246	299	531062	311	<b>81</b>		820414	376
530135	295	530247	299	531063	311	810021	378	820415	377
530140	294	530250	298	531064	311	810173	378	820416	377
530141	294	530251	298	531065	311	<b>82</b>		820419	376
530142	294	530252	298	531066	311	820001	376	820420	376
530143	294	530253	298	531070	309	820008	377	820421	376
530145	295	530256	299	531071	309	820009	377	820422	376
530150	294	530257	299	531072	309	820020	376	820423	376
530151	294	530260	298	531076	309	820031	376	820432	376
530155	295	530261	298	531077	309	820032	376	820601	203
530170	295	530266	299	531078	309	820033	376	820606	377
530171	295	530267	299	<b>62</b>		820035	376	820931	378
530172	295	530270	298	620180	15	820037	376	820943	377
530173	295	530271	298	620230	15	820041	376	820991	377
530174	295	530272	298	620280	15	820049	377	821083	377
530175	295	530282	298	620320	15	820086	376	821154	377
530195	295, 297	530283	298	620660	18	820092	377	821165	377
530196	295, 297	530284	298	620900	16, 25	820097	377	821459	377
530197	295, 297	530286	299	620910	16, 25	820099	379	821768	379
530198	295, 297	530300	299	620920	16, 25	820111	376	821790	379
530199	295, 297	530301	299	620990	16	820116	376	821805	379
530200	45, 298	530302	299	<b>63</b>		820119	377	821806	379
530201	45, 298	530310	299	630280	19	820120	377	821819	379
530202	45, 298	530311	299	630990	19	820121	376	821821	379
530203	45, 298	530312	299	<b>64</b>		820122	376	821822	379
530204	298	530320	299	640180	20	820132	376	821823	379
530205	298	530321	299	640220	20	820134	376	821836	379
530206	299	530322	299	640260	20	820135	377	821852	379
530207	299	530490	299	640360	20	820136	377	<b>83</b>	
530210	298	530491	299	640640	22	820138	376	830001	378
530211	298	531000	310	640691	23	820141	376	830003	378
530212	298	531001	310	640692	23	820145	377	830006	378
530213	298	531002	310	640699	23	820153	377	830007	378
530214	298	531003	310	640900	21	820154	377	830008	378
530215	298	531004	310	640990	20	820181	376	830011	380
530216	299	531005	310	<b>65</b>		820187	377	830012	378

DE	ARTIKELNUMMERN-INDEX
EN	ITEM NUMBER INDEX
IT	INDICE PER CODICE ARTICOLO
ES	ÍNDICE POR CÓDIGO DEL ARTÍCULO

Art.-Nr. / code	S. / p.	Art.-Nr. / code	S. / p.	Art.-Nr. / code	S. / p.	Art.-Nr. / code	S. / p.	Art.-Nr. / code	S. / p.
830017	378	904528	61	995035	68	997260	348		
830018	378	<b>91</b>		995040	68	997280	348		
830019	378	910020	61	995042	68	997300	348		
830020	378	910025	61	995043	68	997320	348		
830021	378	910030	61	995044	68	997360	348		
830024	378	910035	61	995045	68	997400	348		
830025	378	912030	66	995062	68	997450	348		
830027	378	912035	66	995063	68	997500	348		
830033	378	915120	59	995064	68	997620	349		
830040	378	915122	59	995065	68	997621	349		
830047	378	915124	59	995066	68	997622	349		
830048	378	915126	59	995072	69	997623	349		
830050	378	915128	59	995080	70	997624	349		
830056	380	<b>92</b>		995081	70	997625	349		
830057	380	920000	62	995082	70	997630	349		
830063	378	926820	59	995083	70	997631	349		
830090	380	926822	59	995084	70	997632	349		
830091	380	926824	59	995085	70	997633	349		
830092	380	926826	59	995086	70	997634	349		
<b>88</b>		926828	59	995087	70	997635	349		
880001	380	<b>93</b>		995090	70	997636	349		
880002	380	930020	59	995091	70	997637	349		
880003	380	<b>94</b>		995092	70	997638	349		
880005	380	940025	62	995093	70	997639	349		
880006	380	940027	62	995100	70	997640	349		
880007	380	949928	61	995101	70	997641	349		
880008	380	949930	61	995102	70	997642	349		
880015	380	949932	61	995103	70	997660	354		
880019	380	<b>95</b>		995104	70	997810	46		
880026	380	951012	63	995105	70	997811	46		
880052	380	951014	63	995106	70	997820	46		
880053	380	951016	63	995121	69	997821	46		
880115	380	<b>96</b>		995122	69	997840	46		
880174	380	960020	64	995123	69	997841	46		
880258	380	967028	60	995124	69	997890	47		
<b>90</b>		967040	63	995125	69	997899	47		
900020	60	967050	64	995126	69	997900	348		
900024	60	967060	64	995127	69	997901	348		
900026	60	967065	64	995129	69	997902	348		
900028	60	967070	64	995130	69	997903	348		
901050	63	967075	63	995131	69	997904	348		
901314	59	968000	65	995132	69	997910	71		
901316	59	968010	65	995810	46	997911	71		
901318	59	968020	65	995811	46	997912	71		
901320	59	968030	65	995820	46	997913	71		
901322	59	968040	65	995821	46	997914	71		
901324	59	968050	65	995830	46	997920	71		
901326	59	<b>98</b>		995840	46	997921	71		
902028	60	981040	66	995841	46	997941	71		
902032	60	981041	66	995860	47	997942	71		
904024	61	<b>99</b>		995870	47	997943	71		
904026	61	994628	62	995880	47	997944	71		
904028	61	994633	62	995890	47	997976	70		
904030	61	994860	47	997140	348	997977	70		
904032	61	995020	69	997160	348	997986	71		
904034	61	995031	68	997180	348	997987	71		
904036	61	995032	68	997200	348	997988	71		
904524	61	995033	68	997220	348				
904526	61	995034	68	997240	348				

# MATERIALEIGENSCHAFTEN

Material	Eigenschaften	Temperaturbeständigkeit	Pflegehinweis
<b>AC</b> Acryl	Nicht spülmaschineneeignet, sehr gute Oberflächenhärte, hochtransparent	-40 / +50 °C	Reinigung mit einem feuchten Tuch und Spezialreiniger
<b>ABS</b> Acrylnitril-Butadien-Styrol	Bedingt spülmaschineneeignet, sehr gute Oberflächenhärte, temperaturwechselfest, bruchstabil, kratzfest	-30 / +80 °C	Reinigung mit einem feuchten Tuch und mildem Spülmittel, Material kann stumpf werden
<b>ALU</b> Aluminium	Nicht spülmaschineneeignet, bedingt säurebeständig, sehr gute Wärmeleitfähigkeit	+250 °C	Reinigung mit einem feuchten Tuch oder Schwamm und mildem Spülmittel, Verfärbungen sind möglich
<b>SST</b> Edelstahl	Spülmaschineneeignet, temperaturbeständig, lange Lebensdauer	+500 °C	Ggf. Edelstahlreiniger, keine Stahlwolle verwenden
<b>EPP</b> Expandiertes Polypropylen	Spülmaschineneeignet, hohe Isoliereigenschaften, bruchstabil, sehr leicht, recyclebar	-40 / +120 °C	Keine aggressiven Reinigungsmittel verwenden
<b>Exoglass</b>	Spülmaschineneeignet, unzerbrechlich, sterilisierbar	+220 °C	Keine aggressiven Reinigungsmittel verwenden
<b>HDPE</b> Polyethylen mit hoher Dichte Niederdruckverfahren	Bedingt spülmaschineneeignet, hart elastisch, unzerbrechlich, recyclebar	-40 / +95 °C	
<b>WOOD</b> Holz	Nicht spülmaschineneeignet, Naturprodukt, keine homogene Oberfläche		Reinigung mit einem feuchten Tuch, nach Reinigung sofort trocknen
<b>HPVC</b> Hart-Polyvinylchlorid	Nicht spülmaschineneeignet, nicht mikrowelleneeignet, transparent	0 / +60 °C	Reinigung mit einem feuchten Tuch
<b>COPPER</b> Kupfer	Nicht spülmaschineneeignet, die Nutzung mit sauren Nahrungsmitteln, wie Tomaten, Zitronen, Essig oder Wein ist zu vermeiden, da diese durch den Kontakt mit Kupfer oxidieren	Erhitzen Sie das Kochgeschirr mit höchstens 2/3 der maximalen Hitze Ihres Herdes	Nur Handwäsche wird empfohlen
<b>LDPE</b> Polyethylen mit niedriger Dichte Hochdruckverfahren	Bedingt spülmaschineneeignet, weich elastisch, unzerbrechlich, recyclebar, in heißem Wasser ausreichend formbeständig	-40 / +135 °C	
<b>MF</b> Melamin	Bedingt spülmaschineneeignet, hart, sterilisierbar, stoßfest, säurebeständig	-30 / +70 °C	Keine aggressiven Reinigungsmittel verwenden, nicht über 70 °C reinigen
<b>PA</b> Polyamid	Bedingt spülmaschineneeignet, starr, bruch- und schlagfest, mattglänzend	-40 / +120 °C	Keine Intensivreiniger verwenden
<b>PC</b> Polycarbonat	Bedingt spülmaschineneeignet, nicht mikrowelleneeignet, sterilisierbar, unzerbrechlich, sehr stabil	-30 / +135 °C	Reinigung mit einem feuchten Tuch und mildem Spülmittel, Material kann stumpf werden
<b>PE</b> Polyethylen	Bedingt spülmaschineneeignet, bei Einhalten der Temperatur formbeständig	-40 / +80 °C	Nicht über 80 °C reinigen
<b>PET</b> Polyethylenterephthalat	Spülmaschineneeignet, flexibel, bei Einhalten der Temperatur formbeständig	-20 / +110 °C	Keine Intensivreiniger verwenden
<b>POM</b> Polyoxymethylen	Spülmaschineneeignet, sehr hart, bei Einhalten der Temperatur formbeständig, temperaturwechselfest	-40 / +120 °C	Keine Intensivreiniger verwenden
<b>PTFE</b> Polytetrafluorethylen	Spülmaschineneeignet, hoher Antihafteffekt, nicht kratzfest	-70 / +200 °C	Die Beschichtung ist nicht kratzfest, es wird Kunststoff oder Holzequipment zum Arbeiten empfohlen, Vermeidung von Überhitzung
<b>PP</b> Polypropylen	Spülmaschineneeignet, sterilisierbar, unzerbrechlich, sehr stabil, bei Einhalten der Temperatur formbeständig	-40 / +80 °C	Nicht über 80 °C reinigen
<b>PS</b> Polystyrol	Spülmaschineneeignet, sterilisierbar, in heißem Wasser ausreichend formbeständig	-40 / +80 °C	Nicht über 80 °C reinigen
<b>PVC</b> Polyvinylchlorid	Nicht spülmaschineneeignet, nicht mikrowelleneeignet, hohe Reißfestigkeit, abriebfest, resistent gegen verdünnte Säuren und Laugen, säurebeständig	-20 / +100 °C	Reinigung mit einem feuchten Tuch
<b>SI</b> Silikon	Spülmaschineneeignet, hoher Antihafteffekt, flexibel, empfindliche Oberfläche	+280 °C	Backbleche mit Silikonbeschichtung sind nicht spülmaschineneeignet!
<b>STEEL</b> Stahl / Stahlblech (Blaustahl)	Nicht spülmaschineneeignet, sehr gute Wärmeleitfähigkeit, schwer, nicht rostfrei, praktisch nicht überhitzbar		Auf die Beschichtung muss geachtet werden, eine trockene Lagerung wird empfohlen, sowie man das Produkt immer leicht einfetten sollte
<b>SAN</b> Styrol-Acrylnitril	Bedingt spülmaschineneeignet, starr, hochglänzend, kratz-, stoß- und schlagfest	+95 °C	Keine Intensivreiniger verwenden
<b>Cr</b> verchromt	Nicht spülmaschineneeignet, nicht säurefest, temperaturbeständig, glänzend	+40 °C	Reinigung mit einem feuchten Tuch und mildem Spülmittel, keine aggressiven Reinigungsmittel verwenden

(artikelspezifische Abweichungen)

# MATERIAL PROPERTIES

Material	Properties	Temperature resistance	Care instructions
<b>AC</b> Acrylic	Not dishwasher safe, very good surface hardness, highly transparent	- 40 / +50 °C	Cleaning with a damp cloth and special cleaner
<b>ABS</b> Acrylonitrile butadiene styrene	Conditionally dishwasher safe, very good surface hardness, thermal-shock-resistant, break-proof, scratch-proof	-30 / +80 °C	Clean with a damp cloth and mild detergent, material can become dull
<b>ALU</b> Aluminium	Not dishwasher safe, conditionally acid-resistant, very good thermal conductivity	+250 °C	Cleaning with a damp cloth or sponge and mild detergent, discoloration is possible
<b>SST</b> Stainless steel	Dishwasher safe, temperature-resistant, long-lasting	+500 °C	Stainless steel cleaner if necessary, do not use steel wool
<b>EPP</b> Expanded polypropylene	Dishwasher safe, high insulating properties, break-proof, very light, recyclable	- 40 / +120 °C	Do not use aggressive cleaning agents
<b>Exoglass</b>	Dishwasher safe, unbreakable, sterilizable	+220 °C	Do not use aggressive cleaning agents
<b>HDPE</b> High density polyethylene Low pressure process	Conditionally dishwasher safe, hard elastic, unbreakable, recyclable	- 40 / +95 °C	
<b>WOOD</b> Wood	Not dishwasher safe, natural product, no homogeneous surface		Clean with a damp cloth, dry immediately after cleaning
<b>HPVC</b> Rigid polyvinyl chloride	Not dishwasher safe, not microwave safe, transparent	0 / +60 °C	Cleaning with a damp cloth
<b>COPPER</b> Copper	Not dishwasher safe, avoid use with acidic foods such as tomatoes, lemons, vinegar or wine, as they will oxidize on contact with copper	Heat the cookware at no more than 2/3 of the maximum heat of your stove	Only hand wash is recommended
<b>LDPE</b> Polyethylene with low density High pressure process	Conditionally dishwasher safe, soft elastic, unbreakable, recyclable, sufficiently dimensionally stable	- 40 / +135 °C	
<b>MF</b> Melamine	Conditionally dishwasher safe, hard, sterilizable, shock-resistant, acid-resistant	- 30 / +70 °C	Do not use aggressive cleaning agents, do not clean above 70 °C
<b>PA</b> Polyamide	Conditionally dishwasher safe, rigid, break and impact-resistant, matt shiny	- 40 / +120 °C	Do not use intensive cleaning agents
<b>PC</b> Polycarbonate	Conditionally dishwasher safe, not microwave safe, sterilizable, unbreakable, very stable	- 30 / +135 °C	Clean with a damp cloth and mild detergent, material can become dull
<b>PE</b> Polyethylene	Conditionally dishwasher safe, dimensionally stable dimensionally stable when the temperature is observed	- 40 / +80 °C	Do not clean above 80 °C
<b>PET</b> Polyethylene terephthalate	Dishwasher safe, flexible, dimensionally stable when the temperature is observed	- 20 / +110 °C	Do not use intensive cleaning agents
<b>POM</b> Polyoxymethylene	Dishwasher safe, very hard, dimensionally stable when the temperature is observed, thermal-shock-resistant	- 40 / +120 °C	Do not use intensive cleaning agents
<b>PTFE</b> Polytetrafluoroethylene	Dishwasher safe, high non-stick effect, not scratch resistant	- 70 / +200 °C	The coating is not scratch-resistant, plastic or wooden equipment is recommended for working, avoid overheating
<b>PP</b> Polypropylene	Dishwasher safe, sterilizable, unbreakable, very stable, dimensionally stable dimensionally stable when the temperature is observed	- 40 / +80 °C	Do not clean above 80 °C
<b>PS</b> Polystyrene	Dishwasher safe, sterilizable, sufficiently dimensionally stable in hot water	- 40 / +80 °C	Do not clean above 80 °C
<b>PVC</b> Polyvinyl chloride	Not dishwasher safe, not microwave safe, high tear resistance, abrasion resistant, resistant to diluted acids and alkalis, acid-resistant	- 20 / +100 °C	Cleaning with a damp cloth
<b>SI</b> Silicone	Dishwasher safe, high non-stick effect, flexible, sensitive surface	+280 °C	Baking trays with silicone coating are not dishwasher safe!
<b>STEEL</b> Steel / sheet steel (blue steel)	Not dishwasher safe, very good thermal conductivity, heavy, not rust-proof, practically not overheatable		Attention must be paid to the coating, dry storage is recommended, as well as you should always lightly grease the product
<b>SAN</b> Styrene acrylonitrile	Conditionally dishwasher safe, rigid, high shiny, scratch, shock and impact-resistant	+95 °C	Do not use intensive cleaning agents
<b>Cr</b> chrome-plated	Not dishwasher safe, not acid-resistant, temperature-resistant, shiny	+40 °C	Clean with a damp cloth and mild detergent, do not use aggressive cleaning agents

(item specific deviations)

## MATERIAL PIKTOGRAMME | MATERIAL PROPERTIES

<b>ABS</b>	ABS Kunststoff / ABS plastic	<b>PE</b>	Polyethylen / Polyethylene
<b>AC</b>	Acryl / Acrylic	<b>PET</b>	PET Polyester / PET Polyester
<b>ALU</b>	Aluminium / Aluminium	<b>POM</b>	POM Kunststoff / POM plastic
<b>COP PER</b>	Kupfer / Copper	<b>PP</b>	Polypropylen / Polypropylene
<b>Cr</b>	verchromt / chrome-plated	<b>PS</b>	Polystyrol / Polystyrene
<b>EPP</b>	EPP Kunststoff / EPP plastic	<b>PTFE</b>	PTFE Polymer / PTFE polymer
<b>HDPE</b>	HDPE Kunststoff / HDPE plastic	<b>PVC</b>	PVC Polymer / PVC polymer
<b>HPVC</b>	HPVC Polymer / HPVC polymer	<b>SAN</b>	SAN Kunststoff / SAN plastic
<b>LDPE</b>	LDPE Kunststoff / LDPE plastic	<b>SI</b>	Silikon / Silicone
<b>MF</b>	Melamin / Melamine	<b>SST</b>	Edelstahl / Stainless steel
<b>PA</b>	Polyamid / Polyamide	<b>STEEL</b>	Stahl / Stahlblech Steel / Sheet steel
<b>PC</b>	Polycarbonat / Polycarbonate	<b>WOOD</b>	Bambus / Holz Bamboo / Wood

## PRODUKT PIKTOGRAMME | PRODUCT PICTOGRAMS



Antihaftbeschichtung /  
Non-stick coating



Backtemperatur max. 200°C /  
Baking temperature max. 200°C



Beheizbar /  
Heatable



Bruchsicher /  
Break-proof



Einfache Bedienung /  
Easy to use



Elektrisch /  
Electric



Energiesparend /  
Energy-saving



Ergonomisch /  
Ergonomic



Für Ceranfeld geeignet /  
Suitable for ceramic hob



Für Gasofen geeignet /  
Suitable for gas oven



Für Herdplatte geeignet /  
Suitable for hot plate



Für Induktion geeignet /  
Suitable for induction



Gewerbequalität /  
Commercial quality



Glaskeramik /  
Glass ceramic



Handwäsche /  
Hand wash



Hohe Isoliereigenschaften /  
High insulation properties



Lebensmittelecht /  
Food safe



Mikrowellengeeignet /  
Microwave safe



Recyclbar, ökologisch /  
Recyclable, ecological



Schnittfest /  
Cut-resistant



Schlagfest /  
Impact-resistant



Selbstmontage /  
Self-assembly



Sicherheit /  
Safety



Spedition (gesonderte Frachtkosten) /  
Forwarding agent (separate freight charges)



Sperrgut (gesonderte Frachtkosten) /  
Bulky goods (separate freight charges)



Spezialbeschichtung /  
Special coating



Spülmaschinengeeignet /  
Dishwasher safe



Stapelbar /  
Stackable



Temperaturbeständig /  
Temperature-resistant



Timerfunktion /  
Timer function



Wasserdichte Innenoberfläche /  
Waterproof inner surface



SB-fähig in Verpackung /  
Self-service in packaging

## TABELLEN PIKTOGRAMME | TABLE PICTOGRAMS

#	Artikelnummer Item number		Gewicht Weight
	Inhalt / Volumen Content / Volume		Traglast Load capacity
	Länge Length		Leistung (Watt) Power (Watt)
	Breite Width		Spannung (Volt) Voltage (Volt)
	Höhe Height		Umdrehungen pro Minute Rotations per minute
	Tiefe Depth		Perforiert Perforated
	Abmessungen Dimensions		Materialstärke Material thickness
	Innenmaß Inner dimension		Maschenweite Mesh width
	Außenmaß Outer dimension	°C	Temperatur Temperature
	Diverse Maße Various dimensions		Etagen Floors
∅ mm	Durchmesser Diameter		Menge pro Paket Quantity per package
↑ ∅ mm	Oberer Durchmesser Upper diameter		Verpackungseinheit Packing unit
↓ ∅ mm	Unterer Durchmesser Bottom diameter		

### HACCP ✓

#### KENNZEICHNUNG – Verwendungsgebiet COLOR CODING – area of use

- schwarz / black Allgemein / General
- weiss / white Backwaren & Milchprodukte /  
Baked goods & dairy products
- rot / red Rohes Fleisch / Raw meat
- blau / blue Roher Fisch & Krustentiere /  
Raw fish & shellfishes
- grün / green Salat, Obst & Gemüse /  
Salad, fruit & vegetables
- braun / brown Gekochte Lebensmittel oder  
Wurzelgemüse / Cooked food or root  
vegetables
- gelb / yellow Geflügel / Poultry
- violett / purple Halal-Verarbeitung, vegan & allergenfrei /  
Halal processing, vegan & allergen free



Länge / Length

Millimeter / Millimeters (mm)	Zentimeter / Centimeters (cm)	Inches (ins)
3	0,3	1/8
6,25	0,62	1/4
12,5	1,25	1/2
25	2,5	1
50	5	2
75	7,5	3
100	10	4
150	15	6
200	20	8
250	25	10
300	30	12
350	35	14
400	40	16
450	45	18
500	50	20
550	55	22
600	60	24
650	65	26
700	70	28
750	75	30
800	80	32
850	85	34
900	90	36
950	95	38
1000	100	40

Gewicht / Weight

Gramm / Metric grams (g)	Kilogramm / Kilogram (kg)	Masse / imperial Ounces (oz)	/ imperial pounds (lb)
25	0,25	1	
50	0,5	2	
75	0,75	3	
100	0,1	4	1/4
125	0,125	-5	
150	0,15	+5	
175	0,175	6	
200	0,2	7	
225	0,225	8	1/2
250	0,25	9	
275	0,275	10	
300	0,3	11	
325	0,325	12	3/4
350	0,35	+12	
375	0,375	13	
400	0,4	14	
425	0,425	15	
450	0,45	16	1
675	0,675	22	1,5
1000	1,0	35	2,2
1500	1,5	53	3,3
2000	2,0	71	4,4
2500	2,5	88	5,5
3000	3,0	106	6,6
3500	3,5	123	7,7

Volume

Metrik / Metric (ml/l)	Unzen / Imperial Fluid Ounces (floz)	Imperial Pints	Unzen / US Fluid Ounces	US Pints
30 ml	1		1.01	
60 ml	2		2.02	
90 ml	3		3.04	
120 ml	4		4.05	1/4 US pt
150 ml	5	1/4 pt	5.07	
180 ml	6		6.09	
210 ml	7		7.1	
240 ml	8		8.12	1/2 US pt
270 ml	9		9.13	
300 ml	10	1/2 pt	10.14	
330 ml	11		11.16	
360 ml	12		12.17	3/4 US pt
390 ml	13		13.2	
420 ml	14		14.2	
450 ml	15	3/4 pt	15.21	
480 ml	16		16.23	1 US pt
600 ml	20	1 pt	20.28	
960 ml	32		32.46	2 US pt
1 L	35		33.81	2.1 US pt
1.1 L	40	2 pt	37.17	2.32 US pt
5 L	176	8.8 pt	169.07	10.56 US pt
6 L	211	10.56 pt	202.88	12.68 US pt
7 L	246	12.31 pt	236.7	14.75 US pt
8 L	282	14.1 pt	270.51	16.8 US pt
10 L	352	17.6 pt	338.14	21.1 US pt

Temperatur / Temperature

°C	°F
-40	-40
-30	-22
-20	-4
-10	14
0	32
10	50
20	68
30	86
40	104
50	122
60	140
70	158
80	176
90	194
100	212
110	230
120	248
130	266
140	284
150	302
160	320
170	338
180	356
190	374
200	392

## **D**

Unsere Preise verstehen sich zuzüglich der gesetzlichen Mehrwertsteuer. Es gelten unsere allgemeinen Verkaufs-, Lieferungs- und Zahlungsbedingungen.

Alle Texte, Preise und Abbildungen sind ohne Gewähr. Technische Änderungen und Modelländerungen (Online und Print) können ohne vorherige Bekanntmachung vorgenommen werden.

Irrtümer, Fehler sowie Verfügbarkeit vorbehalten. Abmessungen, Inhalte, Volumen und Gewichte sind Circa-Angaben und beziehen sich in der Regel auf randvolle Befüllung. Die Vervielfältigung dieses Kataloges (Online und Print), auch wenn partiell, ist ohne unsere ausdrückliche schriftliche Erlaubnis untersagt.

## **EN**

Our prices exclude Value Added Tax ("VAT"). Our general terms of sale, delivery and payment apply. All texts, prices and illustrations are not binding. We reserve the right to modify the technical characteristics and articles in the catalogue (online and printed) without prior notice. We decline any responsibility for any errors and/or inaccuracies. Availability subject to change. Dimensions, contents, volumes and weights are approximate and usually refer to filling to the brim. Any reproduction of this catalogue (online or print), in whole or in part, is strictly prohibited without our express written consent.

## **IT**

I nostri prezzi si intendono al netto dell'IVA. Si applicano le nostre condizioni generali di vendita, consegna e pagamento. I testi, i prezzi e le illustrazioni non sono vincolanti. Si riserva la facoltà di modificare le caratteristiche tecniche e gli articoli presenti sul catalogo (online e cartaceo) senza preavviso. Si declina ogni responsabilità per eventuali errori e/o imprecisioni. Disponibilità con riserva. Dimensioni, contenuti, volumi e pesi sono approssimativi e di norma si riferiscono al riempimento fino all'orlo. La riproduzione di questo catalogo (online e cartaceo), anche parziale, è vietata senza la nostra esplicita autorizzazione scritta.

## **ES**

Nuestros precios no incluyen IVA. Se aplican nuestras condiciones generales de venta, entrega y pago. Los precios, las descripciones e ilustraciones de los productos no son vinculantes. Nos reservamos el derecho de modificar las características técnicas y los artículos del catálogo (online e impreso) sin previo aviso. Declinamos toda responsabilidad por cualquier error y/o inexactitud. Disponibilidad con reserva. Las dimensiones, el contenido, los volúmenes y los pesos son aproximados y suelen referirse al llenado hasta el borde. La reproducción de este catálogo (online o impreso), total o parcialmente, está prohibida sin nuestro consentimiento expreso por escrito.



## Una qualità nata dalla passione Attrezzature per professionisti

Con oltre 3.000 specialità, la Germania è il paese con la più grande varietà di pane al mondo. Le nostre attrezzature professionali non vengono utilizzate tuttavia solo per la produzione del pane: ogni giorno fornai, pasticceri, gelatieri, cioccolatieri, ristoratori e aziende di catering lavorano con più di 4.500 articoli nostri in oltre 80 paesi del mondo.

Oltre quarant'anni di esperienza sul mercato internazionale come azienda a conduzione familiare, prodotti competitivi e di alta qualità, un servizio orientato al cliente e la nostra ampia gamma di prodotti sono una garanzia di successo per i nostri partner commerciali di lunga data.

La fedeltà dei nostri rivenditori, le consegne rapide in tutto il mondo – anche in dropshipping –, il nostro costante sviluppo e i nuovi prodotti innovativi sono la norma per la nostra azienda.

Usiamo i nostri materiali di produzione con la massima parsimonia possibile. I materiali alternativi e i metodi di produzione a risparmio energetico e conservazione delle risorse sono in primo piano. Uno dei nostri obiettivi è quello di raggiungere la neutralità di CO<sub>2</sub>, tra l'altro attraverso l'uso massiccio di energia solare.

Oltre alla responsabilità ecologica, prestiamo attenzione a condizioni di lavoro eque in tutta la catena del valore. Gestiamo la nostra azienda in modo orientato al futuro al 100 %, per tutti i nostri partner e per il nostro pianeta.



Offizieller Unterstützer  
der Deutschen  
Bäckernationalmannschaft



## La calidad nacida de la pasión Equipos para profesionales

Alemania, con más de 3.000 variedades de pan, tiene el surtido más extenso del mundo. Nuestros equipos profesionales no sólo se utilizan para la fabricación de pan: cada día panaderos, pasteleros, confiteros, heladeros, chocolateros, restauradores y empresas de catering utilizan más de 4.500 artículos nuestros por lo menos en 80 países del mundo.

Más de cuatro décadas de experiencia en el mercado internacional como empresa familiar, productos competitivos y de alta calidad, un servicio orientado al cliente y nuestra amplia cartera de productos son una garantía de éxito para nuestros socios comerciales de larga data.

La lealtad de nuestros distribuidores, las entregas rápidas en todo el mundo – también en dropshipping – así como nuestro desarrollo constante y nuestros nuevos productos innovadores son algo natural para nuestra empresa.

Utilizamos nuestros materiales de producción con la mayor moderación posible. Los materiales alternativos y los métodos de producción que ahorran energía y recursos están en primer plano. Uno de nuestros objetivos es lograr la neutralidad de las emisiones de CO<sub>2</sub>, entre otras cosas mediante el uso masivo de la energía solar.

Además de la responsabilidad ecológica, prestamos atención a unas condiciones laborales justas en toda la cadena de valor. Dirigimos nuestra empresa de forma 100 % orientada al futuro, para todos nuestros socios y para nuestro planeta.

## **Schneider GmbH**

In der Längerts 1  
73095 Albershausen  
GERMANY

☎ +49 (0) 71 61 / 3004 - 0  
info@schneider-gmbh.com

**[www.schneider-gmbh.com](http://www.schneider-gmbh.com)**

